

C-SCF 1,5/6,3X0,8 - Connector

3240156

<https://www.phoenixcontact.com/us/products/3240156>

Please be informed that the data shown in this PDF document is generated from our online catalog. Please find the complete data in the user documentation. Our general terms of use for downloads are valid.



Slip-on sleeve, non-insulated, 0.5 ... 1.5 mm², 6.3 x 0.8

Commercial data

Item number	3240156
Packing unit	100 pc
Minimum order quantity	100 pc
Sales key	BH34
Product key	BH3452
Catalog page	Page 498 (C-3-2019)
GTIN	4046356453738
Weight per piece (including packing)	0.847 g
Weight per piece (excluding packing)	0.82 g
Customs tariff number	85366990
Country of origin	DE

C-SCF 1,5/6,3X0,8 - Connector

3240156

<https://www.phoenixcontact.com/us/products/3240156>

Technical data

Product properties

Product type	Connector
--------------	-----------

Dimensions

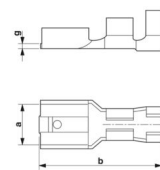
Dimensional drawing	
Width	6.3 mm
Maximum stripping length	7 mm
Min. material thickness	0.4 mm

Material specifications

Color	silver
Material	Brass
Coating	tin-plated
Insulating material	nicht zutreffend
Components	halogen-free

Environmental and real-life conditions

Ambient conditions

Ambient temperature (operation)	110 °C
---------------------------------	--------

C-SCF 1,5/6,3X0,8 - Connector



3240156

<https://www.phoenixcontact.com/us/products/3240156>

Classifications

ECLASS

ECLASS-11.0	27400212
ECLASS-12.0	27400212
ECLASS-13.0	27400212

ETIM

ETIM 9.0	EC001059
----------	----------

UNSPSC

UNSPSC 21.0	27121700
-------------	----------

C-SCF 1,5/6,3X0,8 - Connector



3240156

<https://www.phoenixcontact.com/us/products/3240156>

Environmental product compliance

China RoHS	Environmentally friendly use period: unlimited = EFUP-e No hazardous substances above threshold values
------------	---

Phoenix Contact 2024 © - all rights reserved
<https://www.phoenixcontact.com>

Phoenix Contact USA
586 Fulling Mill Road
Middletown, PA 17057, United States
(+717) 944-1300
info@phoenixcon.com