

C-RC 185/M16 DIN - Ring cable lug

3240133

<https://www.phoenixcontact.com/us/products/3240133>

Please be informed that the data shown in this PDF document is generated from our online catalog. Please find the complete data in the user documentation. Our general terms of use for downloads are valid.



Ring cable lug, non-insulated, 185 mm², M16

Your advantages

- The CRIMPFOX-RC... tools from our CRIMPFOX range of crimping pliers are available for optimum crimping
- The hard-soldered press zone enables maximum conductor pull-out values to be achieved
- The ring cable lugs without plastic sleeve are made from high-quality tin-plated electrolytic copper for maximum protection against corrosion

Commercial data

Item number	3240133
Packing unit	20 pc
Minimum order quantity	20 pc
Sales key	BH34
Product key	BH3422
Catalog page	Page 491 (C-3-2019)
GTIN	4046356453509
Weight per piece (including packing)	104.8 g
Weight per piece (excluding packing)	104.8 g
Customs tariff number	85369010
Country of origin	CN

C-RC 185/M16 DIN - Ring cable lug

3240133

<https://www.phoenixcontact.com/us/products/3240133>

Technical data

Product properties

Product type	Connector
--------------	-----------

Dimensions

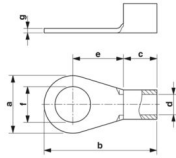
Dimensional drawing	
Width	36 mm
Length of the insulating material sleeve	28 mm
Maximum stripping length	31 mm
Distance from the center to the insulating material sleeve	22 mm
Min. material thickness	3.5 mm
Inner dimensions of the insulating collar	21 mm

Internal dimensions

Internal diameter	17 mm
-------------------	-------

Material specifications

Color	silver
Material	Copper
Coating	tin-plated

Environmental and real-life conditions

Ambient conditions

Ambient temperature (operation)	110 °C
---------------------------------	--------

Standards and regulations

Design according to standard	DIN 46234
------------------------------	-----------

C-RC 185/M16 DIN - Ring cable lug



3240133

<https://www.phoenixcontact.com/us/products/3240133>

Classifications

ECLASS

ECLASS-11.0	27400204
ECLASS-13.0	27400204
ECLASS-12.0	27400204

ETIM

ETIM 9.0	EC001052
----------	----------

UNSPSC

UNSPSC 21.0	27121700
-------------	----------

C-RC 185/M16 DIN - Ring cable lug



3240133

<https://www.phoenixcontact.com/us/products/3240133>

Environmental product compliance

China RoHS	Environmentally friendly use period: unlimited = EFUP-e
	No hazardous substances above threshold values

Phoenix Contact 2024 © - all rights reserved
<https://www.phoenixcontact.com>

Phoenix Contact USA
586 Fulling Mill Road
Middletown, PA 17057, United States
(+717) 944-1300
info@phoenixcon.com