

SFP 1-15/120AC - EMC filter surge protection device



2920683

<https://www.phoenixcontact.com/us/products/2920683>

Please be informed that the data shown in this PDF document is generated from our online catalog. Please find the complete data in the user documentation. Our general terms of use for downloads are valid.



Device protection, according to type 3/class III, with mains interference filter to prevent high-frequency interference voltages, for 1-phase power supply networks with separate N and PE (3-conductor system: L1, N, PE), with remote indication contact.

Product description

Device protection with interference filter

Your advantages

- Optimized protective effect with combined protective circuit for absorbing transient overvoltages for attenuating high-frequency interference
- Symmetrical design of the protective circuit with surge protection components on the input and output sides of the filter
- Protection against excessive heating with thermal monitoring of the protective circuit
- Versatile in use with universal circuit design

Commercial data

Item number	2920683
Packing unit	1 pc
Minimum order quantity	1 pc
Sales key	CL06
Product key	CLC131
Catalog page	Page 209 (C-4-2019)
GTIN	4046356158565
Weight per piece (including packing)	611.3 g
Weight per piece (excluding packing)	571.28 g
Customs tariff number	85363010
Country of origin	DE

SFP 1-15/120AC - EMC filter surge protection device



2920683

<https://www.phoenixcontact.com/us/products/2920683>

Technical data

Notes

General

Note	For IT systems: only install the device in 120 V IT systems with common HV/LV grounding system.
------	---

Product properties

Type	DIN rail module, one-piece
Product type	EMC filters
Product family	SFP
Number of positions	2
For country-specific use in	USA, CN, BR
Surge protection fault message	Optical, remote indicator contact

Insulation characteristics

Overvoltage category	III
Pollution degree	2
IEC test classification	III
	T3
EN type	T3
Number of ports	Two

Electrical properties

Indicator/remote signaling

Connection name	Remote fault indicator contact
Switching function	Changeover contact
Operating voltage	12 V AC ... 250 V AC
	250 V DC (250 mA DC)
Operating current	100 mA AC ... 1 A AC
	1 A DC (48 V DC)

Connection data

Connection method	Screw terminal blocks
Screw thread	M3
Tightening torque	0.5 Nm ... 0.6 Nm
	4.5 lb _F -in. ... 5.5 lb _F -in.
Conductor cross section flexible	2.5 mm ² ... 4 mm ²
Conductor cross section rigid	2.5 mm ² ... 6 mm ²
Conductor cross section AWG	14 ... 10

Dimensions

SFP 1-15/120AC - EMC filter surge protection device



2920683

<https://www.phoenixcontact.com/us/products/2920683>

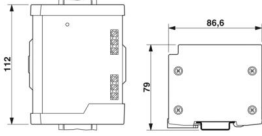
Dimensional drawing	
Width	112 mm
Height	86.6 mm
Depth	79 mm

Material specifications

Color	black (RAL 9005) Silver
Flammability rating according to UL 94	V-0
Insulating material	ABS
Housing material	Aluminum

Mechanical properties

Mechanical data

Open side panel	No
-----------------	----

Protective circuit

Mode of protection	L-N L-PE N-PE
Direction of action	L-N & L(N)-PE
Nominal voltage U_N	120 V AC (TN) 120 V AC (TT - only in use with RCD) 120 V AC (IT)
Nominal frequency f_N	50 Hz (60 Hz)
Maximum continuous voltage U_C	150 V AC
Rated load current I_L	15 A (50 °C)
Residual current I_{PE}	≤ 0.6 mA
Standby power consumption P_C	≤ 7.50 VA (at U_{REF}) ≤ 10.00 VA (at U_C)
Reference test voltage U_{REF}	132.00 V AC
Nominal discharge current I_n (8/20) μ s	3 kA
Combination wave U_{OC}	6 kV (3 kA)
Voltage protection level U_p	≤ 0.45 kV
TOV behavior at U_T (L-N)	175 V AC (5 s / withstand mode) 240 V AC (5 s / safe failure mode) 208 V AC (120 min / safe failure mode) 208 V AC (5 s / withstand mode)

SFP 1-15/120AC - EMC filter surge protection device



2920683

<https://www.phoenixcontact.com/us/products/2920683>

TOV behavior at U_T (L-PE)	175 V AC (120 min / withstand mode)
	1332 V AC (200 ms / safe failure mode)
TOV behavior at U_T (N-PE)	1200 V AC (200 ms / safe failure mode)
Response time t_A	≤ 25 ns
Capacity (L-N)	1 μ F ± 10 %
	10 nF ± 10 % (X2-275 V)
Capacity (L-PE)	2.2 nF ± 20 % (Y2-250 V)
Capacity (N-PE)	2.2 nF ± 20 % (Y2-250 V)
Max. required back-up fuse	20 A (MCB B/general purpose)
	16 A (IT - MCB B/general purpose)
Input attenuation aE, sym.	20 dB (≥ 100 kHz / 50 Ω)
Input attenuation aE, asym.	30 dB (≥ 1 MHz / 50 Ω)
Short-circuit current rating I_{SCCR}	5 kA AC (TN/TT)
	1 kA AC (IT)

Filter data

Discharge resistance	820 k Ω
----------------------	----------------

Environmental and real-life conditions

Ambient conditions

Degree of protection	IP20
Ambient temperature (operation)	-25 °C ... 70 °C
Ambient temperature (storage/transport)	-25 °C ... 70 °C
Permissible humidity (operation)	5 % ... 95 %

Approvals

UL specifications

Maximum continuous operating voltage MCOV (L-N)	150 V AC
Maximum continuous operating voltage MCOV (L-G)	150 V AC
Maximum continuous operating voltage MCOV (N-G)	150 V AC
Short-circuit current rating (SCCR)	5 kA
Voltage protection rating VPR (L-N)	500 V
Voltage protection rating VPR (L-G)	500 V
Voltage protection rating VPR (N-G)	500 V
Nominal discharge current I_n	3 kA
Mode of protection	L-N
	L-G
	N-G
Power distribution system	Single phase
Nominal frequency	50/60 Hz
SPD Type	2CA

UL indicator/remote signaling

Operating voltage	12 V AC ... 250 V AC
-------------------	----------------------

SFP 1-15/120AC - EMC filter surge protection device



2920683

<https://www.phoenixcontact.com/us/products/2920683>

DC operating voltage	250 V DC (250 mA DC)
AC operating current	100 mA AC ... 1 A AC
DC operating current	1 A DC (48 V DC)

UL connection data

Tightening torque	5 lb _F -in. ... 7 lb _F -in.
Conductor cross section AWG	12 ... 10

Standards and regulations

Air clearances and creepage distances

Standards/regulations	DIN VDE 0110-1 / IEC 60664-1 / IEC 61643-1
Standards/specifications	IEC 61643-11
Note	2011
Standards/specifications	EN 61643-11
Note	2012

Mounting

Mounting type	DIN rail: 35 mm
---------------	-----------------

SFP 1-15/120AC - EMC filter surge protection device



2920683

<https://www.phoenixcontact.com/us/products/2920683>

Classifications

ECLASS

ECLASS-11.0	27130806
ECLASS-13.0	27171203

ETIM

ETIM 9.0	EC000942
----------	----------

UNSPSC

UNSPSC 21.0	39121600
-------------	----------

SFP 1-15/120AC - EMC filter surge protection device



2920683

<https://www.phoenixcontact.com/us/products/2920683>

Environmental product compliance

REACH SVHC	Lead 7439-92-1
	Dechlorane Plus
	Hexahydromethylphthalic anhydride
China RoHS	Environmentally Friendly Use Period = 50 years
	For information on hazardous substances, refer to the manufacturer's declaration available under "Downloads"

Phoenix Contact 2024 © - all rights reserved
<https://www.phoenixcontact.com>

Phoenix Contact USA
586 Fulling Mill Road
Middletown, PA 17057, United States
(+717) 944-1300
info@phoenixcon.com