

BC 161,6 OT U22 KMGY - Upper housing part



2278526

<https://www.phoenixcontact.com/us/products/2278526>

Please be informed that the data shown in this PDF document is generated from our online catalog. Please find the complete data in the user documentation. Our general terms of use for downloads are valid.



DIN rail housing for use in distribution boards in accordance with DIN 43880, Upper housing part (U22) with vents, Installation depth connection technology: 22.35 mm, width: 161.6 mm, height: 89.7 mm, depth: 54.85 mm, color: light grey (similar RAL 7035)

Your advantages

- Coordinated housing and connection system for faster device development
- Individual online configuration for diverse applications in building automation
- Variety of connection technology
- Can be mounted on the DIN rail or the wall
- With DIN-rail-mountable bus connector and power connector system as an option
- Tool-free mounting
- Available in overall widths from one to nine HP (17.8 mm ... 161.6 mm)
- Compliant with DIN EN 43880

Commercial data

Item number	2278526
Packing unit	10 pc
Minimum order quantity	10 pc
Sales key	AC10
Product key	ACHBAB
Catalog page	Page 700 (C-1-2013)
GTIN	4046356299473
Weight per piece (including packing)	55.82 g
Weight per piece (excluding packing)	55.34 g
Customs tariff number	84879090
Country of origin	DE

BC 161,6 OT U22 KMGY - Upper housing part

2278526

<https://www.phoenixcontact.com/us/products/2278526>

Technical data

Notes

General	Refer to the data sheet for the range in the download area.
---------	---

Product properties

Product type	Upper housing part
Housing series	BC
Product family	BC OT U22
Max. number of positions	96 (pitch: 2.5 mm) 72 (pitch: 3.5 mm) 54 (pitch: 5 mm) 36 (pitch: 7.5 mm)
Type	Upper housing part (U22) with vents
Housing type	DIN rail housing for use in distribution boards in accordance with DIN 43880
Ventilation openings present	yes

Dimensions

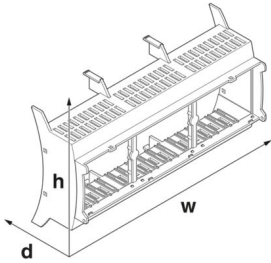
Dimensional drawing	
Width	161.6 mm
Height	89.7 mm
Depth	54.85 mm
Horizontal pitch	9 Div.

PCB design

PCB thickness	1.4 mm ... 1.8 mm
---------------	-------------------

Material specifications

Color (Housing)	light grey (RAL 7035)
Flammability rating according to UL 94	V0
Surface characteristics	untreated
Housing material	Polycarbonate

Environmental and real-life conditions

Vibration test

Specification	IEC 60068-2-6:2007-12
---------------	-----------------------

BC 161,6 OT U22 KMGY - Upper housing part



2278526

<https://www.phoenixcontact.com/us/products/2278526>

Frequency	10 - 150 - 10 Hz
Sweep speed	1 octave/min
Amplitude	0.15 mm (10 Hz ... 58.1 Hz)
Acceleration	2g (58.1 Hz ... 150 Hz)
Test duration per axis	2.5 h
Test directions	X-, Y- and Z-axis

Glow-wire test

Specification	IEC 60695-2-11:2014-02
Temperature	850 °C
Time of exposure	30 s

Mechanical strength / tumbling barrel

Specification	IEC 60068-2-31:2008-05
Height of fall	50 cm
Frequency	50

Shocks

Specification	IEC 60068-2-27:2008-02
Pulse shape	Half-sine
Acceleration	15g
Shock duration	11 ms
Number of shocks per direction	3
Test directions	X-, Y- and Z-axis (pos. and neg.)

Degree of protection (IP code)

Specification	IEC 60529:1989-11 + AMD 1:1999-11 + AMD 2:2013-08
---------------	---

Ambient conditions

Max. IP code to attain	IP20
Ambient temperature (operation)	-40 °C ... 105 °C (depending on power dissipation)
Ambient temperature (storage/transport)	-40 °C ... 70 °C
Ambient temperature (assembly)	-5 °C ... 100 °C
Relative humidity (storage/transport)	95 %

PCB data

Number of PCB holders	18
Type of PCB mount	Latching
Thickness of the PCB	1.4 mm ... 1.8 mm

Mounting

Mounting type	Snap in
Mounting position	Vertical (horizontal DIN rail)

Packaging specifications

Type of packaging	packed in cardboard
Outer packaging type	Carton

BC 161,6 OT U22 KMGY - Upper housing part



2278526

<https://www.phoenixcontact.com/us/products/2278526>

Classifications

ECLASS

ECLASS-11.0	27182702
ECLASS-13.0	27190603

ETIM

ETIM 9.0	EC001031
----------	----------

UNSPSC

UNSPSC 21.0	31261500
-------------	----------

BC 161,6 OT U22 KMGY - Upper housing part



2278526

<https://www.phoenixcontact.com/us/products/2278526>

Environmental product compliance

China RoHS	Environmentally friendly use period: unlimited = EFUP-e
	No hazardous substances above threshold values

Phoenix Contact 2024 © - all rights reserved
<https://www.phoenixcontact.com>

Phoenix Contact USA
586 Fulling Mill Road
Middletown, PA 17057, United States
(+717) 944-1300
info@phoenixcon.com