

# ZEC 1,0/ 4-LPV-3,5 C1 - PCB connector



1915673

<https://www.phoenixcontact.com/us/products/1915673>

Please be informed that the data shown in this PDF document is generated from our online catalog. Please find the complete data in the user documentation. Our general terms of use for downloads are valid.



PCB connector, nominal cross section: 1 mm<sup>2</sup>, color: green, nominal current: 8 A, rated voltage (III/2): 200 V, contact surface: Tin, contact connection type: Socket, number of potentials: 4, number of rows: 1, number of positions: 4, number of connections: 4, product range: ZEC 1,0/-LPV, pitch: 3.5 mm, mounting: Direct plug-in method, conductor/PCB connection direction: 0 °, number of solder pins per potential: 2, plug-in system: ZEC, locking: without, mounting: without, type of packaging: packed in cardboard

## Your advantages

- Easy component connection
- Inexpensive direct plug-in connection with just one component

## Commercial data

Item number	1915673
Packing unit	50 pc
Minimum order quantity	50 pc
Sales key	AA02
Product key	AABEBA
Catalog page	Page 365 (C-1-2013)
GTIN	4017918181505
Weight per piece (including packing)	2.98 g
Weight per piece (excluding packing)	2.68 g
Customs tariff number	85366930
Country of origin	GR

# ZEC 1,0/ 4-LPV-3,5 C1 - PCB connector



1915673

<https://www.phoenixcontact.com/us/products/1915673>

## Technical data

### Product properties

Type	PCB connector
Product line	COMBICON Connectors S
Product type	PCB connector
Product family	ZEC 1,0/...-LPV
Number of positions	4
Pitch	3.5 mm
Number of connections	4
Number of rows	1
Mounting flange	without
Number of potentials	4
Solder pins per potential	2

### Electrical properties

Nominal current $I_N$	8 A
Nominal voltage $U_N$	200 V
Degree of pollution	3
Contact resistance	1.2 m $\Omega$
Rated voltage (III/3)	160 V
Rated surge voltage (III/3)	2.5 kV
Rated voltage (III/2)	200 V
Rated surge voltage (III/2)	2.5 kV
Rated voltage (II/2)	320 V
Rated surge voltage (II/2)	2.5 kV

### Mounting

Mounting type	Direct plug-in method
---------------	-----------------------

### Material specifications

#### Material data - contact

Note	WEEE/RoHS-compliant, free of whiskers according to IEC 60068-2-82/JEDEC JESD 201
Contact material	Cu alloy
Surface characteristics	hot-dip tin-plated
Metal surface contact area (top layer)	Tin (4 - 8 $\mu$ m Sn)

#### Material data - housing

Color (Housing)	green (6021)
Insulating material	PA
Insulating material group	I
CTI according to IEC 60112	600
Flammability rating according to UL 94	V0

# ZEC 1,0/ 4-LPV-3,5 C1 - PCB connector



1915673

<https://www.phoenixcontact.com/us/products/1915673>

Glow wire flammability index GWFI according to EN 60695-2-12	850
Glow wire ignition temperature GWIT according to EN 60695-2-13	775
Temperature for the ball pressure test according to EN 60695-10-2	125 °C

## Notes

Notes on operation	In accordance with IEC 61984, COMBICON connectors have no switching power (COC). During designated use, they must not be plugged in or disconnected when carrying voltage or under load.
--------------------	--

## Dimensions

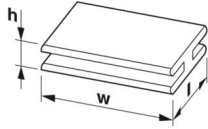
Dimensional drawing	
Pitch	3.5 mm
Width [w]	15.4 mm
Height [h]	7 mm
Length [l]	22.9 mm
Installed height	7 mm

## Mechanical tests

### Insertion and withdrawal forces

Result	Test passed
No. of cycles	20
Insertion strength per pos. approx.	6 N
Withdraw strength per pos. approx.	5 N

### Resistance of inscriptions

Specification	IEC 60068-2-70:1995-12
Result	Test passed

### Visual inspection

Specification	IEC 60512-2:1985-00
Result	Test passed

### Dimension check

Specification	IEC 60512-2:1985-00
Result	Test passed

## Electrical tests

### Air clearances and creepage distances |

Specification	IEC 60664-1:2007-04
---------------	---------------------

# ZEC 1,0/ 4-LPV-3,5 C1 - PCB connector



1915673

<https://www.phoenixcontact.com/us/products/1915673>

Insulating material group	I
Comparative tracking index (IEC 60112)	CTI 600
Rated insulation voltage (III/3)	160 V
Rated surge voltage (III/3)	2.5 kV
minimum clearance value - non-homogenous field (III/3)	1.5 mm
minimum creepage distance (III/3)	2 mm
Rated insulation voltage (III/2)	200 V
Rated surge voltage (III/2)	2.5 kV
minimum clearance value - non-homogenous field (III/2)	1.5 mm
minimum creepage distance (III/2)	1.5 mm
Rated insulation voltage (II/2)	320 V
Rated surge voltage (II/2)	2.5 kV
minimum clearance value - non-homogenous field (II/2)	1.5 mm
minimum creepage distance (II/2)	1.6 mm

## Environmental and real-life conditions

### Vibration test

Specification	IEC 60068-2-6:1995-03
Frequency	10 - 150 - 10 Hz
Sweep speed	1 octave/min
Amplitude	0.35 mm (10 Hz ... 60.1 Hz)
Sweep speed	5g (60.1 Hz ... 150 Hz)
Test duration per axis	2.5 h

### Durability test

Specification	IEC 60512-5:1992-08
Contact resistance R <sub>1</sub>	1.2 mΩ
Contact resistance R <sub>2</sub>	1.5 mΩ
Insertion/withdrawal cycles	20

### Climatic test

Specification	ISO 6988:1985-02
Corrosive stress	0.2 dm <sup>3</sup> SO <sub>2</sub> on 300 dm <sup>3</sup> /40 °C/1 cycle
Thermal stress	100 °C/168 h
Power-frequency withstand voltage	1.39 kV

### Ambient conditions

Ambient temperature (operation)	-40 °C ... 100 °C (dependent on the derating curve)
Ambient temperature (storage/transport)	-40 °C ... 70 °C
Relative humidity (storage/transport)	30 % ... 70 %
Ambient temperature (assembly)	-5 °C ... 100 °C

## Packaging specifications

Type of packaging	packed in cardboard
-------------------	---------------------

# ZEC 1,0/ 4-LPV-3,5 C1 - PCB connector



1915673

<https://www.phoenixcontact.com/us/products/1915673>

## Classifications

### ECLASS

ECLASS-11.0	27460201
ECLASS-12.0	27460201
ECLASS-13.0	27460201

### ETIM

ETIM 9.0	EC002637
----------	----------

### UNSPSC

UNSPSC 21.0	39121400
-------------	----------

# ZEC 1,0/ 4-LPV-3,5 C1 - PCB connector



1915673

<https://www.phoenixcontact.com/us/products/1915673>

## Environmental product compliance

China RoHS	Environmentally friendly use period: unlimited = EFUP-e
	No hazardous substances above threshold values

Phoenix Contact 2024 © - all rights reserved  
<https://www.phoenixcontact.com>

Phoenix Contact USA  
586 Fulling Mill Road  
Middletown, PA 17057, United States  
(+717) 944-1300  
[info@phoenixcon.com](mailto:info@phoenixcon.com)