

KGG-MC 1,5/ 9 - Cable housing



1834411

<https://www.phoenixcontact.com/us/products/1834411>

Please be informed that the data shown in this PDF document is generated from our online catalog. Please find the complete data in the user documentation. Our general terms of use for downloads are valid.

Cable housing, pitch: 3.81 mm, number of positions: 9, dimension a: 36.68 mm, color: green



Commercial data

Item number	1834411
Packing unit	10 pc
Minimum order quantity	10 pc
Sales key	AA08
Product key	AAHZDB
Catalog page	Page 243 (C-1-2013)
GTIN	4017918110758
Weight per piece (including packing)	9.905 g
Weight per piece (excluding packing)	9.49 g
Customs tariff number	39269097
Country of origin	PL

KGG-MC 1,5/ 9 - Cable housing

1834411

<https://www.phoenixcontact.com/us/products/1834411>

Technical data

Product properties

Product type	Cable housing
Product family	KGG-MC 1,5
Number of positions	9
Pitch	3.81 mm

Material specifications

Color	green
Flammability rating according to UL 94	HB
Insulating material group	I
Insulating material	ABS

Dimensions

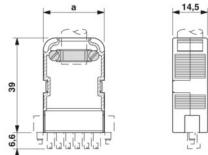
Dimensional drawing	
Width	14.5 mm
Height	45.6 mm
Pitch	3.81 mm

KGG-MC 1,5/ 9 - Cable housing



1834411

<https://www.phoenixcontact.com/us/products/1834411>

Classifications

ECLASS

ECLASS-11.0	27460402
ECLASS-13.0	27460402
ECLASS-12.0	27460402

ETIM

ETIM 9.0	EC002943
----------	----------

UNSPSC

UNSPSC 21.0	39121400
-------------	----------

KGG-MC 1,5/ 9 - Cable housing

1834411

<https://www.phoenixcontact.com/us/products/1834411>



Environmental product compliance

China RoHS	Environmentally friendly use period: unlimited = EFUP-e
	No hazardous substances above threshold values

Phoenix Contact 2024 © - all rights reserved
<https://www.phoenixcontact.com>

Phoenix Contact USA
586 Fulling Mill Road
Middletown, PA 17057, United States
(+717) 944-1300
info@phoenixcon.com