

UMSTBVK 2,5/19-GF-5,08 - DIN rail connector



1788091

<https://www.phoenixcontact.com/us/products/1788091>

Please be informed that the data shown in this PDF document is generated from our online catalog. Please find the complete data in the user documentation. Our general terms of use for downloads are valid.



DIN rail connector, nominal cross section: 2.5 mm², color: green, nominal current: 12 A, rated voltage (III/2): 320 V, contact surface: Tin, contact connection type: Pin, number of potentials: 19, number of rows: 1, number of positions: 19, number of connections: 19, product range: UMSTBVK 2,5/...-GF, pitch: 5.08 mm, connection method: Screw connection with tension sleeve, screw head form: L Slotted, mounting: DIN rail, conductor/PCB connection direction: 0 °, number of solder pins per potential: 1, plug-in system: COMBICON MSTB 2,5, Pin connector pattern alignment: Standard, locking: Screw locking mechanism, mounting: Threaded flange, type of packaging: packed in cardboard

Your advantages

- Direct plug-in block with universal foot for mounting on NS 32 or NS 35 DIN rail
- Can be combined with the MSTB 2,5 range
- Screwable flange for superior mechanical stability
- Well-known connection principle allows worldwide use

Commercial data

Item number	1788091
Packing unit	50 pc
Minimum order quantity	50 pc
Note	Made to order (non-returnable)
Sales key	AA03
Product key	AACMFD
Catalog page	Page 205 (CC-2005)
GTIN	4017918043155
Weight per piece (including packing)	55.35 g
Weight per piece (excluding packing)	49.678 g
Customs tariff number	85366990
Country of origin	DE

UMSTBVK 2,5/19-GF-5,08 - DIN rail connector



1788091

<https://www.phoenixcontact.com/us/products/1788091>

Technical data

Product properties

Type	DIN rail mounting
Product line	COMBICON Connectors M
Product type	DIN rail connector
Product family	UMSTBVK 2,5/...-GF
Number of positions	19
Pitch	5.08 mm
Number of connections	19
Number of rows	1
Mounting flange	Threaded flange
Number of potentials	19
Solder pins per potential	1

Electrical properties

Nominal current I_N	12 A
Nominal voltage U_N	320 V
Degree of pollution	3
Contact resistance	2.9 m Ω
Rated voltage (III/3)	320 V
Rated surge voltage (III/3)	4 kV
Rated voltage (III/2)	320 V
Rated surge voltage (III/2)	4 kV
Rated voltage (II/2)	630 V
Rated surge voltage (II/2)	4 kV

Connection data

Connection technology

Type	DIN rail mounting
Connector system	COMBICON MSTB 2,5
Nominal cross section	2.5 mm ²
Contact connection type	Pin

Interlock

Locking type	Screw locking mechanism
Mounting flange	Threaded flange
Tightening torque	0.3 Nm

Conductor connection

Connection method	Screw connection with tension sleeve
Connection direction of the conductor to plug-in direction	0 °
Conductor cross section rigid	0.2 mm ² ... 2.5 mm ²
Conductor cross section flexible	0.2 mm ² ... 2.5 mm ²

UMSTBVK 2,5/19-GF-5,08 - DIN rail connector



1788091

<https://www.phoenixcontact.com/us/products/1788091>

Conductor cross section AWG	24 ... 12
Conductor cross section flexible, with ferrule without plastic sleeve	0.25 mm ² ... 2.5 mm ²
Conductor cross section, flexible, with ferrule, with plastic sleeve	0.25 mm ² ... 2.5 mm ²
2 conductors with same cross section, solid	0.2 mm ² ... 1 mm ²
2 conductors with same cross section, flexible	0.2 mm ² ... 1.5 mm ²
2 conductors with same cross section, flexible, with ferrule without plastic sleeve	0.25 mm ² ... 1 mm ²
2 conductors with the same cross section, flexible, with TWIN ferrule with plastic sleeve	0.5 mm ² ... 1.5 mm ²
Cylindrical gauge a x b / diameter	2.8 mm x 2.0 mm / 2.4 mm
Stripping length	7 mm
Tightening torque	0.5 Nm ... 0.6 Nm

Mounting

Mounting type	DIN rail
Drive form screw head	Slotted (L)
Drive form screw head	Slotted (L)

Flange

Tightening torque	0.3 Nm
-------------------	--------

Material specifications

Material data - contact

Note	WEEE/RoHS-compliant, free of whiskers according to IEC 60068-2-82/JEDEC JESD 201
Contact material	Cu alloy
Surface characteristics	Tin-plated
Metal surface terminal point (top layer)	Tin (5 - 7 µm Sn)
Metal surface terminal point (middle layer)	Nickel (2 - 3 µm Ni)
Metal surface contact area (top layer)	Tin (5 - 7 µm Sn)
Metal surface contact area (middle layer)	Nickel (2 - 3 µm Ni)

Material data - housing

Color (Housing)	green (6021)
Insulating material	PA
Insulating material group	I
CTI according to IEC 60112	600
Flammability rating according to UL 94	V0
Glow wire flammability index GWFI according to EN 60695-2-12	850
Glow wire ignition temperature GWIT according to EN 60695-2-13	775
Temperature for the ball pressure test according to EN 60695-10-2	125 °C

Notes

UMSTBVK 2,5/19-GF-5,08 - DIN rail connector



1788091

<https://www.phoenixcontact.com/us/products/1788091>

Notes on operation	In accordance with IEC 61984, COMBICON connectors have no switching power (COC). During designated use, they must not be plugged in or disconnected when carrying voltage or under load.
--------------------	--

Dimensions

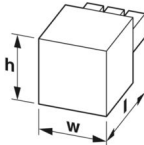
Dimensional drawing	
Pitch	5.08 mm
Width [w]	107.84 mm
Height [h]	34.6 mm
Length [l]	42.5 mm

Mechanical tests

Test for conductor damage and slackening

Specification	IEC 60999-1:1999-11
Result	Test passed

Pull-out test

Specification	IEC 60999-1:1999-11
Conductor cross section/conductor type/tractive force setpoint/actual value	0.14 mm ² / solid / > 10 N
	0.14 mm ² / flexible / > 10 N
	2.5 mm ² / solid / > 50 N
	2.5 mm ² / flexible / > 50 N

Insertion and withdrawal forces

Result	Test passed
No. of cycles	25
Insertion strength per pos. approx.	8 N
Withdraw strength per pos. approx.	6 N

Torque test

Specification	IEC 60999-1:1999-11
---------------	---------------------

Contact holder in insert

Specification	IEC 60512-15-1:2008-05
Contact holder in insert Requirements >20 N	Test passed

Resistance of inscriptions

Specification	IEC 60068-2-70:1995-12
Result	Test passed

Polarization and coding

Specification	IEC 60512-13-5:2006-02
---------------	------------------------

UMSTBVK 2,5/19-GF-5,08 - DIN rail connector



1788091

<https://www.phoenixcontact.com/us/products/1788091>

Result	Test passed
--------	-------------

Visual inspection

Specification	IEC 60512-1-1:2002-02
Result	Test passed

Dimension check

Specification	IEC 60512-1-2:2002-02
Result	Test passed

Electrical tests

Thermal test | Test group C

Specification	IEC 60512-5-1:2002-02
Tested number of positions	20

Insulation resistance

Specification	IEC 60512-3-1:2002-02
Insulation resistance, neighboring positions	> 5 MΩ

Air clearances and creepage distances |

Specification	IEC 60664-1:2007-04
Insulating material group	I
Comparative tracking index (IEC 60112)	CTI 600
Rated insulation voltage (III/3)	320 V
Rated surge voltage (III/3)	4 kV
minimum clearance value - non-homogenous field (III/3)	3 mm
minimum creepage distance (III/3)	4 mm
Rated insulation voltage (III/2)	320 V
Rated surge voltage (III/2)	4 kV
minimum clearance value - non-homogenous field (III/2)	3 mm
minimum creepage distance (III/2)	3 mm
Rated insulation voltage (II/2)	630 V
Rated surge voltage (II/2)	4 kV
minimum clearance value - non-homogenous field (II/2)	3 mm
minimum creepage distance (II/2)	3.2 mm

Environmental and real-life conditions

Vibration test

Specification	IEC 60068-2-6:2007-12
Frequency	10 - 150 - 10 Hz
Sweep speed	1 octave/min
Amplitude	0.35 mm (10 Hz ... 60.1 Hz)
Sweep speed	5g (60.1 Hz ... 150 Hz)
Test duration per axis	2.5 h

UMSTBVK 2,5/19-GF-5,08 - DIN rail connector



1788091

<https://www.phoenixcontact.com/us/products/1788091>

Durability test

Specification	IEC 60512-9-1:2010-03
Impulse withstand voltage at sea level	4.8 kV
Contact resistance R ₁	2.9 mΩ
Contact resistance R ₂	2.9 mΩ
Insertion/withdrawal cycles	25
Insulation resistance, neighboring positions	> 5 MΩ

Climatic test

Specification	ISO 6988:1985-02
Corrosive stress	0.2 dm ³ SO ₂ on 300 dm ³ /40 °C/1 cycle
Thermal stress	100 °C/168 h
Power-frequency withstand voltage	2.21 kV

Ambient conditions

Ambient temperature (operation)	-40 °C ... 100 °C (dependent on the derating curve)
Ambient temperature (storage/transport)	-40 °C ... 70 °C
Relative humidity (storage/transport)	30 % ... 70 %
Ambient temperature (assembly)	-5 °C ... 100 °C

Packaging specifications

Type of packaging	packed in cardboard
-------------------	---------------------

UMSTBVK 2,5/19-GF-5,08 - DIN rail connector



1788091

<https://www.phoenixcontact.com/us/products/1788091>

Classifications

ECLASS

ECLASS-11.0	27141106
ECLASS-12.0	27141106
ECLASS-13.0	27141106

ETIM

ETIM 9.0	EC001284
----------	----------

UNSPSC

UNSPSC 21.0	39121400
-------------	----------

UMSTBVK 2,5/19-GF-5,08 - DIN rail connector



1788091

<https://www.phoenixcontact.com/us/products/1788091>

Environmental product compliance

REACH SVHC	Lead 7439-92-1
China RoHS	Environmentally Friendly Use Period = 50 years
	For information on hazardous substances, refer to the manufacturer's declaration available under "Downloads"

Phoenix Contact 2024 © - all rights reserved

<https://www.phoenixcontact.com>

Phoenix Contact USA
586 Fulling Mill Road
Middletown, PA 17057, United States
(+717) 944-1300
info@phoenixcon.com