

HC-B 6-ADP/1 DSUB 9 - Adapter plate



1775457

<https://www.phoenixcontact.com/us/products/1775457>

Please be informed that the data shown in this PDF document is generated from our online catalog. Please find the complete data in the user documentation. Our general terms of use for downloads are valid.

D-SUB adapter plate, for one D-SUB connector, no. of positions 9, housing series HC-B 6...



Commercial data

Item number	1775457
Packing unit	2 pc
Minimum order quantity	2 pc
Sales key	BF66
Product key	BF7AZD
Catalog page	Page 665 (C-2-2019)
GTIN	4017918038052
Weight per piece (including packing)	14.95 g
Weight per piece (excluding packing)	13.5 g
Customs tariff number	39269097
Country of origin	DE

HC-B 6-ADP/1 DSUB 9 - Adapter plate

1775457

<https://www.phoenixcontact.com/us/products/1775457>

Technical data

Notes

General	For housing HC-B6
---------	-------------------

Product properties

Type	B6
Product type	Adapter plate
Number of positions	9
Seal present	no

Dimensions

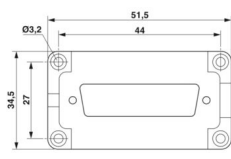
Dimensional drawing	
Width	34.5 mm
Height	10 mm
Length	51.5 mm

Material specifications

Material	PA
Flammability rating according to UL 94	HB

Environmental and real-life conditions

Ambient conditions

Ambient temperature (operation)	-20 °C ... 100 °C
---------------------------------	-------------------

Mounting

Assembly instructions	Mounting position of the adapter plate in the sleeve housing: T is visible after mounting in the housing. Mounting position of the adapter plate in the panel mounting base/socket housing/coupling housing: A is visible after mounting in the housing. Mounting position of the D-SUB (after mounting in the housing): in front of the mounting panel (front mounting)
-----------------------	--

HC-B 6-ADP/1 DSUB 9 - Adapter plate



1775457

<https://www.phoenixcontact.com/us/products/1775457>

Classifications

ECLASS

ECLASS-11.0	27440201
ECLASS-12.0	27440201
ECLASS-13.0	27440201

ETIM

ETIM 9.0	EC002309
----------	----------

UNSPSC

UNSPSC 21.0	31261500
-------------	----------

HC-B 6-ADP/1 DSUB 9 - Adapter plate



1775457

<https://www.phoenixcontact.com/us/products/1775457>

Environmental product compliance

REACH SVHC	Lead 7439-92-1
China RoHS	Environmentally Friendly Use Period = 50 years
	For information on hazardous substances, refer to the manufacturer's declaration available under "Downloads"

Phoenix Contact 2024 © - all rights reserved

<https://www.phoenixcontact.com>

Phoenix Contact USA
586 Fulling Mill Road
Middletown, PA 17057, United States
(+717) 944-1300
info@phoenixcon.com