

DFK-IPC 16/ 4-ST-10,16 - Feed-through plug



1703713

<https://www.phoenixcontact.com/us/products/1703713>

Please be informed that the data shown in this PDF document is generated from our online catalog. Please find the complete data in the user documentation. Our general terms of use for downloads are valid.

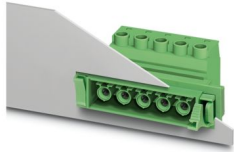

Feed-through connector, nominal cross section: 16 mm², color: green, nominal current: 76 A, rated voltage (III/2): 1000 V, contact surface: Silver, contact connection type: Socket, number of potentials: 4, number of rows: 1, number of positions: 4, number of connections: 4, product range: DFK-IPC 16/..-ST, pitch: 10.16 mm, connection method: Screw connection with tension sleeve, screw head form: L Slotted, conductor/PCB connection direction: 0 °, plug-in system: COMBICON PC 16, Pin connector pattern alignment: Standard, locking: without, mounting: without, type of packaging: packed in cardboard

Your advantages

- Well-known connection principle allows worldwide use
- Low temperature rise, thanks to maximum contact force
- Allows connection of two conductors
- Flange system enables secure fixing to the housing panel by means of tool-free snap-in locking or screws
- Inverted connector with pin contacts for touch-proof device outputs or free-hanging cable/cable connections
- Integrated double steel spring provides additional safety in the event of temperature and power fluctuations

Commercial data

Item number	1703713
Packing unit	10 pc
Minimum order quantity	10 pc
Note	Made to order (non-returnable)
Sales key	AA05
Product key	AAEWBA
Catalog page	Page 584 (C-1-2013)
GTIN	4017918994556
Weight per piece (including packing)	49.1 g
Weight per piece (excluding packing)	48.08 g
Customs tariff number	85366990
Country of origin	PL

DFK-IPC 16/ 4-ST-10,16 - Feed-through plug



1703713

<https://www.phoenixcontact.com/us/products/1703713>

Technical data

Product properties

Type	Feed-through header
Product line	COMBICON Connectors XL
Product type	Feed-through connector
Product family	DFK-IPC 16/...-ST
Number of positions	4
Pitch	10.16 mm
Number of connections	4
Number of rows	1
Mounting flange	without
Number of potentials	4

Electrical properties

Nominal current I_N	76 A
Nominal voltage U_N	1000 V
Degree of pollution	3
Contact resistance	0.35 m Ω
Rated voltage (III/3)	1000 V
Rated surge voltage (III/3)	8 kV
Rated voltage (III/2)	1000 V
Rated surge voltage (III/2)	8 kV
Rated voltage (II/2)	1000 V
Rated surge voltage (II/2)	6 kV

Connection data

Connection technology

Type	Feed-through header
Connector system	COMBICON PC 16
Nominal cross section	16 mm ²
Contact connection type	Socket

Interlock

Locking type	without
Mounting flange	without

Conductor connection

Connection method	Screw connection with tension sleeve
Connection direction of the conductor to plug-in direction	0 °
Conductor cross section rigid	0.75 mm ² ... 16 mm ²
Conductor cross section flexible	0.75 mm ² ... 16 mm ²
Conductor cross section AWG	18 ... 6
Conductor cross section flexible, with ferrule without plastic	0.5 mm ² ... 16 mm ² (Only in connection with CRIMPFOX 16 S)

DFK-IPC 16/ 4-ST-10,16 - Feed-through plug



1703713

<https://www.phoenixcontact.com/us/products/1703713>

sleeve	
Conductor cross section, flexible, with ferrule, with plastic sleeve	0.5 mm ² ... 16 mm ² (Only in connection with CRIMPFOX 16 S)
2 conductors with same cross section, solid	0.75 mm ² ... 6 mm ²
2 conductors with same cross section, flexible	0.75 mm ² ... 6 mm ²
2 conductors with same cross section, flexible, with ferrule without plastic sleeve	0.5 mm ² ... 4 mm ²
2 conductors with the same cross section, flexible, with TWIN ferrule with plastic sleeve	0.5 mm ² ... 6 mm ²
Cylindrical gauge a x b / diameter	- / 5.4 mm
Stripping length	12 mm
Tightening torque	1.7 Nm ... 1.8 Nm

Mounting

Drive form screw head	Slotted (L)
Drive form screw head	Slotted (L)

Material specifications

Material data - contact

Note	WEEE/RoHS-compliant, free of whiskers according to IEC 60068-2-82/JEDEC JESD 201
Contact material	Cu alloy
Surface characteristics	Electroplated silver
Metal surface terminal point (top layer)	Silver (4 - 8 µm Ag)
Metal surface contact area (top layer)	Silver (4 - 8 µm Ag)

Material data - housing

Color (Housing)	green (6021)
Insulating material	PA
Insulating material group	I
CTI according to IEC 60112	600
Flammability rating according to UL 94	V0
Glow wire flammability index GWFI according to EN 60695-2-12	850
Glow wire ignition temperature GWIT according to EN 60695-2-13	775
Temperature for the ball pressure test according to EN 60695-10-2	125 °C

Notes

Notes on operation	In accordance with IEC 61984, COMBICON connectors have no switching power (COC). During designated use, they must not be plugged in or disconnected when carrying voltage or under load.
--------------------	--

Dimensions

DFK-IPC 16/ 4-ST-10,16 - Feed-through plug

1703713

<https://www.phoenixcontact.com/us/products/1703713>

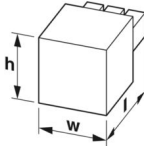
Dimensional drawing	
Pitch	10.16 mm
Width [w]	64.76 mm
Height [h]	32.05 mm
Length [l]	56.4 mm
Installed height	32.05 mm

Mechanical tests

Test for conductor damage and slackening

Specification	IEC 60999-1:1999-11
Result	Test passed

Pull-out test

Specification	IEC 60999-1:1999-11
Conductor cross section/conductor type/tractive force setpoint/actual value	0.75 mm ² / solid / > 30 N
	0.75 mm ² / flexible / > 30 N
	16 mm ² / solid / > 100 N
	16 mm ² / flexible / > 100 N

Insertion and withdrawal forces

Result	Test passed
No. of cycles	50
Insertion strength per pos. approx.	10 N
Withdraw strength per pos. approx.	8 N

Torque test

Specification	IEC 60999-1:1999-11
---------------	---------------------

Contact holder in insert

Specification	IEC 60512-15-1:2008-05
Contact holder in insert Requirements >20 N	Test passed

Resistance of inscriptions

Specification	IEC 60068-2-70:1995-12
Result	Test passed

Polarization and coding

Specification	IEC 60512-13-5:2006-02
Result	Test passed

Visual inspection

DFK-IPC 16/ 4-ST-10,16 - Feed-through plug



1703713

<https://www.phoenixcontact.com/us/products/1703713>

Specification	IEC 60512-1-1:2002-02
Result	Test passed

Dimension check

Specification	IEC 60512-1-2:2002-02
Result	Test passed

Electrical tests

Thermal test | Test group C

Specification	IEC 60512-5-1:2002-02
Tested number of positions	9

Insulation resistance

Specification	IEC 60512-3-1:2002-02
Insulation resistance, neighboring positions	> 5 MΩ

Air clearances and creepage distances |

Specification	IEC 60664-1:2007-04
Insulating material group	I
Comparative tracking index (IEC 60112)	CTI 600
Rated insulation voltage (III/3)	1000 V
Rated surge voltage (III/3)	8 kV
minimum clearance value - non-homogenous field (III/3)	8 mm
minimum creepage distance (III/3)	12.5 mm
Rated insulation voltage (III/2)	1000 V
Rated surge voltage (III/2)	8 kV
minimum clearance value - non-homogenous field (III/2)	8 mm
minimum creepage distance (III/2)	8 mm
Rated insulation voltage (II/2)	1000 V
Rated surge voltage (II/2)	6 kV
minimum clearance value - non-homogenous field (II/2)	5.5 mm
minimum creepage distance (II/2)	5.5 mm

Environmental and real-life conditions

Vibration test

Specification	IEC 60068-2-6:2007-12
Frequency	10 - 150 - 10 Hz
Sweep speed	1 octave/min
Amplitude	0.35 mm (10 Hz ... 60.1 Hz)
Sweep speed	5g (60.1 Hz ... 150 Hz)
Test duration per axis	2.5 h

Durability test

Specification	IEC 60512-9-1:2010-03
Impulse withstand voltage at sea level	9.8 kV

DFK-IPC 16/ 4-ST-10,16 - Feed-through plug



1703713

<https://www.phoenixcontact.com/us/products/1703713>

Contact resistance R_1	0.35 m Ω
Contact resistance R_2	0.34 m Ω
Insertion/withdrawal cycles	50
Insulation resistance, neighboring positions	> 5 M Ω

Climatic test

Specification	ISO 6988:1985-02
Corrosive stress	0.2 dm ³ SO ₂ on 300 dm ³ /40 °C/1 cycle
Thermal stress	100 °C/168 h
Power-frequency withstand voltage	4.26 kV

Ambient conditions

Ambient temperature (operation)	-40 °C ... 100 °C (dependent on the derating curve)
Ambient temperature (storage/transport)	-40 °C ... 70 °C
Relative humidity (storage/transport)	30 % ... 70 %
Ambient temperature (assembly)	-5 °C ... 100 °C

Packaging specifications

Type of packaging	packed in cardboard
-------------------	---------------------

DFK-IPC 16/ 4-ST-10,16 - Feed-through plug



1703713

<https://www.phoenixcontact.com/us/products/1703713>

Classifications

ECLASS

ECLASS-11.0	27460202
ECLASS-12.0	27460202
ECLASS-13.0	27460202

ETIM

ETIM 9.0	EC002638
----------	----------

UNSPSC

UNSPSC 21.0	39121400
-------------	----------

DFK-IPC 16/ 4-ST-10,16 - Feed-through plug



1703713

<https://www.phoenixcontact.com/us/products/1703713>

Environmental product compliance

China RoHS	Environmentally friendly use period: unlimited = EFUP-e
	No hazardous substances above threshold values

Phoenix Contact 2024 © - all rights reserved
<https://www.phoenixcontact.com>

Phoenix Contact USA
586 Fulling Mill Road
Middletown, PA 17057, United States
(+717) 944-1300
info@phoenixcon.com