

Conductor connectors - QPD C 3PE2,5 2X6-10 BK - 1582211

Please be informed that the data shown in this PDF Document is generated from our Online Catalog. Please find the complete data in the user's documentation. Our General Terms of Use for Downloads are valid (<http://phoenixcontact.com/download>)



Conductor connectors, QUICKON connection, number of positions: 3+PE, 1 mm² ... 2.5 mm², 690 V, 20 A, black, With two QUICKON nuts, cable diameter range: 6 mm ... 10 mm, QUICKON fast connection

Your advantages

- ✓ Innovative and time saving - QUICKON fast connection for time saving of up to 80 % for on-site connection
- ✓ Convenient: quick and easy assembly without special tools
- ✓ Robust throughout: housing with IP68/IP69K and IK07 protection for a wide range of applications
- ✓ Safer connection with mechanical coding to protect against mismatching, and touch-proof protection in accordance with DIN EN 0105
- ✓ Easy and safe - with the cable connector, you can repair or extend cables quickly, in combination with the connector as well as the coupling connection



Key Commercial Data

Packing unit	1 pc
GTIN	 4 046356 316941
GTIN	4046356316941
Weight per Piece (excluding packing)	60.000 g
Custom tariff number	85366990
Country of origin	Germany

Technical data

General

Type	QPD 4x2,5
Color	black
Locking type	Screw locking
Connection method	QUICKON connection

Conductor connectors - QPD C 3PE2,5 2X6-10 BK - 1582211

Technical data

General

	IDC connection
Number of positions	4
Note number of positions	3+PE
Wrench size, union nut	22 mm
Tightening torque, union nut	5 Nm
Tightening torque, counter nut	5 Nm
Conductor cross section flexible min.	1 mm ²
Conductor cross section flexible max.	2.5 mm ²
Conductor cross section solid min.	1 mm ²
Conductor cross section solid max.	2.5 mm ²
Conductor cross section AWG min.	16
Conductor cross section AWG max.	14

Cabel

Structure of individual litz in acc. with VDE 0295 / smallest wire diameter	VDE 0295 class 1 to 6/min. 0.15 mm
Wire insulation material	PVC/PE/TPE/rubber
Wire diameter including insulation	2 mm ... 3.8 mm
External cable diameter	6 mm ... 10 mm
Position marking	1, 2, 3, PE

Ambient conditions

Degree of protection	IP66
	IP68 (2 m / 24 h)
	IP69K
Ambient temperature (operation)	-40 °C ... 100 °C
Ambient temperature (storage/transport)	-40 °C ... 100 °C
Temperature when conductor connected	-5 °C ... 50 °C

Electrical characteristics

Nominal current I _N	20 A
Nominal voltage U _N	690 V
Rated current	20 A
rated voltage (III/3)	690 V
rated voltage (III/2)	1000 V
rated voltage (II/2)	1000 V
Rated surge voltage (III/3)	6 kV
Rated surge voltage (III/2)	8 kV
Rated surge voltage (II/2)	8 kV

Conductor connectors - QPD C 3PE2,5 2X6-10 BK - 1582211

Technical data

Mechanical characteristics

QUICKON connectability	max. 10
Insertion/withdrawal cycles	max. 50
Category of shock impact	IK07

Material data

Contact material	Cu
Contact surface material	silver-plated
Contact carrier material	PA
Insulating material	PA
Flammability rating according to UL 94	V0
Overvoltage category	III
Degree of pollution	3

Standards and Regulations

Category of shock impact	IK07
Halogen-free	no
Flammability rating according to UL 94	V0

Environmental Product Compliance

China RoHS	Environmentally friendly use period: unlimited = EFUP-e
	No hazardous substances above threshold values

Drawings

Diagram

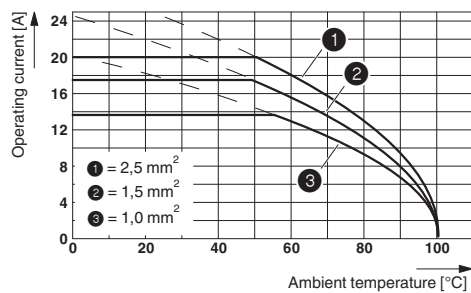

Dimensional drawing

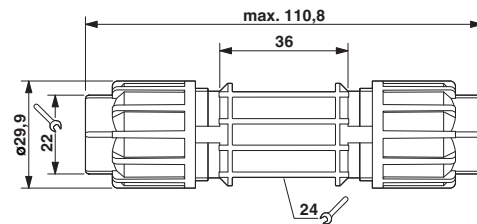

Dimensional drawing

Conductor connectors - QPD C 3PE2,5 2X6-10 BK - 1582211

Schematic diagram

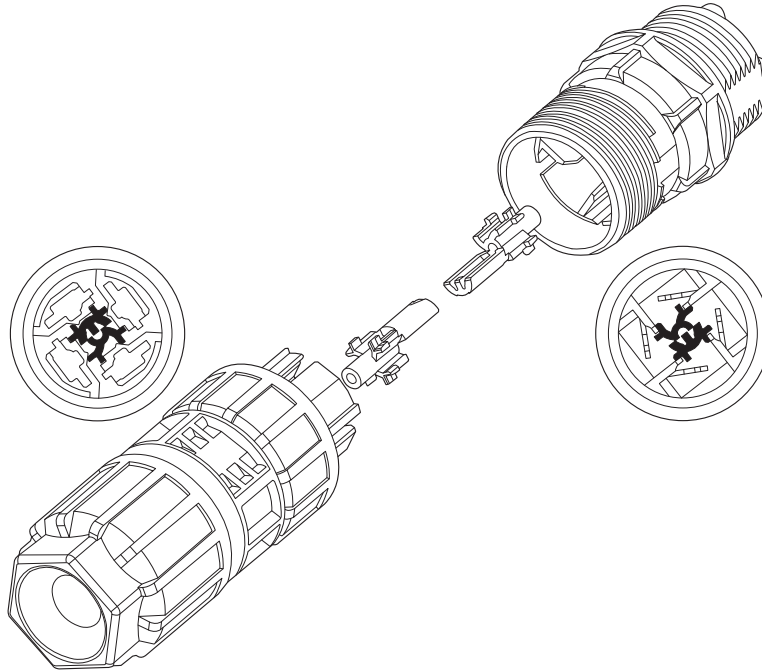

Encoding of the QUICKON connector

Classifications

eCl@ss

eCl@ss 10.0.1	27440605
eCl@ss 11.0	27440605
eCl@ss 4.0	27140800
eCl@ss 4.1	27140800
eCl@ss 5.0	27143400
eCl@ss 5.1	27143400
eCl@ss 6.0	27143400
eCl@ss 7.0	27440605
eCl@ss 9.0	27440605

ETIM

ETIM 3.0	EC000437
ETIM 4.0	EC000516
ETIM 6.0	EC002560
ETIM 7.0	EC002560

Conductor connectors - QPD C 3PE2,5 2X6-10 BK - 1582211

Classifications

UNSPSC

UNSPSC 6.01	30211923
UNSPSC 7.0901	39121522
UNSPSC 11	39121522
UNSPSC 12.01	39121522
UNSPSC 13.2	39121402
UNSPSC 18.0	39121402
UNSPSC 19.0	39121402
UNSPSC 20.0	39121402
UNSPSC 21.0	39121402

Approvals

Approvals

Approvals

UL Listed / cUL Listed / UL Listed / IECCEB Scheme / cUL Listed / EAC / DNV GL / EAC / VDE Zeichengenehmigung

Ex Approvals

Approval details

UL Listed		http://database.ul.com/cgi-bin/XYV/template/LISEXT/1FRAME/index.htm	FILE E 468743
Nominal voltage UN		600 V	
Nominal current IN		10 A	
mm ² /AWG/kcmil		16	

cUL Listed		http://database.ul.com/cgi-bin/XYV/template/LISEXT/1FRAME/index.htm	FILE E 468743
Nominal voltage UN		600 V	
Nominal current IN		10 A	
mm ² /AWG/kcmil		16	

Conductor connectors - QPD C 3PE2,5 2X6-10 BK - 1582211

Approvals

UL Listed		http://database.ul.com/cgi-bin/XYV/template/LISEXT/1FRAME/index.htm	E221474
-----------	---	---	---------

IECEE CB Scheme		http://www.iecee.org/	DE1-58228
-----------------	---	---	-----------

cUL Listed		http://database.ul.com/cgi-bin/XYV/template/LISEXT/1FRAME/index.htm	E221474
------------	---	---	---------

EAC			RU C- DE.AI30.B.01102
-----	---	--	--------------------------

DNV GL		https://approvalfinder.dnvgl.com/	TAE00003J5
--------	---	---	------------

EAC			RU C- DE.BL08.B.00511
-----	---	--	--------------------------

VDE Zeichengenehmigung		http://www2.vde.com/de/Institut/Online-Service/VDE-gepruefteProdukte/Seiten/Online-Suche.aspx	40029149
------------------------	---	---	----------

Nominal voltage UN	690 V
Nominal current IN	20 A
mm ² /AWG/kcmil	1.5-2.5