

Bus system T-connector - SAC-5P-MINT/2XMIN DN - 1401029

Please be informed that the data shown in this PDF Document is generated from our Online Catalog. Please find the complete data in the user's documentation. Our General Terms of Use for Downloads are valid (<http://phoenixcontact.com/download>)

Bus system T-connector, DeviceNet™, 5-position, unshielded, Plug straight 7/8"-16UNF, on Socket straight 7/8"-16UNF and Socket straight 7/8"-16UNF, Parallel distributor



Key Commercial Data

Packing unit	1 pc
GTIN	 4 046356 542616
GTIN	4046356542616
Weight per Piece (excluding packing)	80.000 g
Custom tariff number	85366990
Country of origin	Germany

Technical data

Ambient conditions

Degree of protection	IP65
	IP67
Ambient temperature (operation)	-40 °C ... 80 °C (Plug / socket)

General data

Rated current at 40°C	10 A (at 25 °C)
Rated voltage	63 V DC
Number of positions	5
Signal type/category	DeviceNet™
Overvoltage category	II
Degree of pollution	3

Bus system T-connector - SAC-5P-MINT/2XMIN DN - 1401029

Technical data

General data

Alternative short product description	T distributor
Insertion/withdrawal cycles	≥ 100
Contact material	CuZn
Contact carrier material	PA
Contact surface material	AU

Standards and Regulations

Flammability rating according to UL 94	HB
--	----

Environmental Product Compliance

REACH SVHC	Lead 7439-92-1
China RoHS	Environmentally Friendly Use Period = 50 years
	For details about hazardous substances go to tab "Downloads", Category "Manufacturer's declaration"

Drawings

Schematic diagram

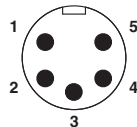

Pin assignment, plug, 7/8"-16UNF, 5-pos., view of male side

Schematic diagram

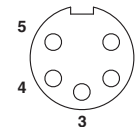

Pin assignment, socket, 7/8"-16UNF, 5-pos., view of female side

Dimensional drawing

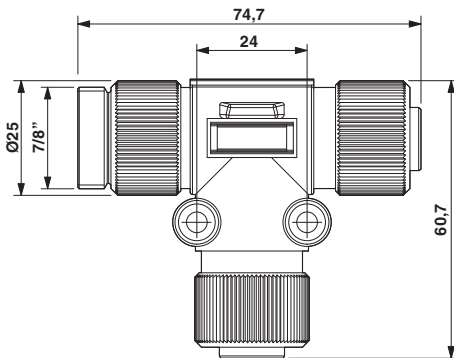

T-distributor 7/8", top view

Circuit diagram

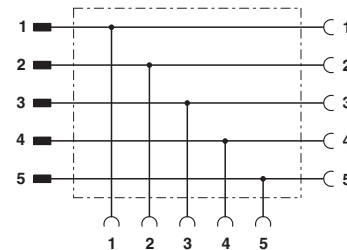

Contact assignment of the 7/8" T-distributor

Bus system T-connector - SAC-5P-MINT/2XMIN DN - 1401029

Classifications

eCl@ss

eCl@ss 10.0.1	27440106
eCl@ss 11.0	27440106
eCl@ss 4.0	27260700
eCl@ss 4.1	27260700
eCl@ss 5.0	27260700
eCl@ss 5.1	27260700
eCl@ss 6.0	27260700
eCl@ss 7.0	27440102
eCl@ss 9.0	27440106

ETIM

ETIM 2.0	EC000830
ETIM 3.0	EC001855
ETIM 4.0	EC000421
ETIM 6.0	EC002925
ETIM 7.0	EC002925

UNSPSC

UNSPSC 6.01	31251501
UNSPSC 7.0901	31251501
UNSPSC 11	31251501
UNSPSC 12.01	31251501
UNSPSC 13.2	39121413
UNSPSC 19.0	31251501
UNSPSC 20.0	31251501
UNSPSC 21.0	31251501

Approvals

Approvals

Approvals

EAC / UL Listed / UL Listed

Ex Approvals

Bus system T-connector - SAC-5P-MINT/2XMIN DN - 1401029

Approvals

Approval details

EAC			RU C- DE.BL08.B.00511
-----	---	--	--------------------------

UL Listed		http://database.ul.com/cgi-bin/XYV/template/LISEXT/1FRAME/index.htm	FILE E 221474
-----------	---	---	---------------

UL Listed		http://database.ul.com/cgi-bin/XYV/template/LISEXT/1FRAME/index.htm	FILE E 221474
-----------	---	---	---------------

Nominal voltage UN	250 V
Nominal current IN	8 A