

TMC 1 F1 200 1,0A - Thermomagnetic device circuit breaker



0914251

<https://www.phoenixcontact.com/us/products/0914251>

Please be informed that the data shown in this PDF document is generated from our online catalog. Please find the complete data in the user documentation. Our general terms of use for downloads are valid.



Thermal-magnetic circuit breaker, 1-pos., fast blow, 1 N/C contact, with universal foot for mounting on NS 32 or NS 35

Commercial data

Item number	0914251
Packing unit	1 pc
Note	Made to order (non-returnable)
Sales key	CL04
Product key	CLA121
Catalog page	Page 282 (CL-2002)
GTIN	4017918008932
Weight per piece (including packing)	71.05 g
Weight per piece (excluding packing)	69.05 g
Customs tariff number	85362010
Country of origin	DE

TMC 1 F1 200 1,0A - Thermomagnetic device circuit breaker



0914251

<https://www.phoenixcontact.com/us/products/0914251>

Technical data

Product properties

Type	DIN rail module, one-piece
Product type	Thermomagnetic device circuit breakers
Product family	TMC
Number of positions	1
Number of connections	4
Number of rows	2
No. of channels	1

Insulation characteristics

Overvoltage category	II
Degree of pollution	2

Electrical properties

Fuse type	Automatic device
-----------	------------------

General

Rated voltage	65 V DC
Rated current I_N	1 A
Rated surge voltage	2.5 kV
Insulation resistance R_{iso}	> 100 M Ω (500 V DC)
Auxiliary circuit	240 V AC / 1 A (Low-induction) 65 V AC / 1 A (Low-induction)
Tripping method	TM (thermomagnetic)
Device resistance	1.6 Ω
Rated short-circuit switching capacity I_{cn}	2500 A (32 V DC)
Short-circuit switching capacity	2000 A (UL 1077: 65 V DC)
Dielectric strength	3000 V AC (Actuation area) 3000 V AC (Main to auxiliary circuit)
Switching cycles, max.	10000 (At $1 \times I_N$, inductive)
Fuse	F1 (fast blow)

Indicator/remote signaling

Connection name	Auxiliary contact
Operating voltage	250 V AC 65 V DC
Operating current	1 A AC (Low-induction)

Connection data

Main contact

Screw thread	M3
Tightening torque	0.6 ... 0.8 Nm

TMC 1 F1 200 1,0A - Thermomagnetic device circuit breaker



0914251

<https://www.phoenixcontact.com/us/products/0914251>

Stripping length	12 mm
Internal cylindrical gage	A3
Conductor cross section rigid	0.2 mm ² ... 6 mm ²
Cross section AWG	24 ... 10 (converted acc. to IEC)
Conductor cross section flexible	0.2 mm ² ... 4 mm ²
Conductor cross-section flexible (ferrule without plastic sleeve)	0.25 mm ² ... 4 mm ²
Flexible conductor cross section (ferrule with plastic sleeve)	0.25 mm ² ... 2.5 mm ²
2 conductors with same cross section, solid	0.2 mm ² ... 0.75 mm ²
2 conductors with same cross section, flexible	0.2 mm ² ... 0.75 mm ²
2 conductors with same cross section, flexible, with ferrule without plastic sleeve	0.25 mm ² ... 1 mm ²
2 conductors with the same cross section, flexible, with TWIN ferrule with plastic sleeve	0.5 mm ² ... 2.5 mm ²
Nominal current	1 A

Auxiliary contact

Screw thread	M3
Tightening torque	0.6 ... 0.8 Nm
Stripping length	12 mm
Internal cylindrical gage	A1
Conductor cross section rigid	0.2 mm ² ... 2.5 mm ²
Cross section AWG	24 ... 14 (converted acc. to IEC)
Conductor cross section flexible	0.2 mm ² ... 1.5 mm ²
Conductor cross-section flexible (ferrule without plastic sleeve)	0.25 mm ² ... 2.5 mm ²
Flexible conductor cross section (ferrule with plastic sleeve)	0.25 mm ² ... 1.5 mm ²
2 conductors with same cross section, solid	0.2 m ² ... 0.75 m ²
2 conductors with same cross section, flexible	0.2 m ² ... 0.75 mm ²
2 conductors with same cross section, flexible, with ferrule without plastic sleeve	0.25 mm ² ... 0.5 mm ²
2 conductors with the same cross section, flexible, with TWIN ferrule with plastic sleeve	0.5 mm ² ... 0.75 mm ²

Main contact

Connection method	Screw connection
Screw thread	M3
Tightening torque	0.6 Nm ... 0.8 Nm
Stripping length	12 mm
Conductor cross section flexible	0.2 mm ² ... 4 mm ²
Conductor cross section rigid	0.2 mm ² ... 6 mm ²
Conductor cross section AWG	24 ... 10
Conductor cross section, flexible, with ferrule, with plastic sleeve	0.25 mm ² ... 2.5 mm ²
Conductor cross section flexible, with ferrule without plastic sleeve	0.25 mm ² ... 4 mm ²

Auxiliary contact

Connection method	Screw connection
Screw thread	M3

TMC 1 F1 200 1,0A - Thermomagnetic device circuit breaker

0914251

<https://www.phoenixcontact.com/us/products/0914251>

Tightening torque	0.6 Nm ... 0.8 Nm
Stripping length	12 mm
Conductor cross section flexible	0.2 mm ² ... 1.5 mm ²
Conductor cross section rigid	0.2 mm ² ... 2.5 mm ²
Conductor cross section AWG	24 ... 14
Conductor cross section, flexible, with ferrule, with plastic sleeve	0.25 mm ² ... 1.5 mm ²
Conductor cross section flexible, with ferrule without plastic sleeve	0.25 mm ² ... 2.5 mm ²

Dimensions

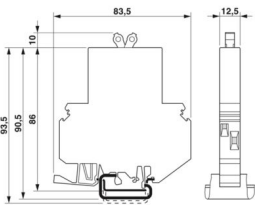
Dimensional drawing	
Width	12.5 mm
Height	82.5 mm
Depth	96 mm

Material specifications

Color	black (RAL 9005)
Flammability rating according to UL 94	V-2
Insulating material group	II
Insulating material	PA66

Mechanical properties

Mechanical data

Open side panel	No
-----------------	----

Environmental and real-life conditions

Ambient conditions

Degree of protection	IP30 (Actuation area) IP20 (Connection area)
Ambient temperature (operation)	-30 °C ... 60 °C
Humidity test	240 h, 95 % RH, 40 °C

Standards and regulations

Standards/specifications	EN 60934
Standards/specifications	UL 1077

Mounting

Mounting type	DIN rail: 35 mm
---------------	-----------------

TMC 1 F1 200 1,0A - Thermomagnetic device circuit breaker



0914251

<https://www.phoenixcontact.com/us/products/0914251>

Classifications

ECLASS

ECLASS-11.0	27141116
ECLASS-12.0	27141116
ECLASS-13.0	27140401

ETIM

ETIM 9.0	EC000899
----------	----------

UNSPSC

UNSPSC 21.0	39121400
-------------	----------

TMC 1 F1 200 1,0A - Thermomagnetic device circuit breaker



0914251

<https://www.phoenixcontact.com/us/products/0914251>

Environmental product compliance

REACH SVHC	Lead 7439-92-1
China RoHS	Environmentally Friendly Use Period = 25;
	For information on hazardous substances, refer to the manufacturer's declaration available under "Downloads"

Phoenix Contact 2024 © - all rights reserved

<https://www.phoenixcontact.com>

Phoenix Contact USA
586 Fulling Mill Road
Middletown, PA 17057, United States
(+717) 944-1300
info@phoenixcon.com