

FOC-FDX20-PP-SCD6-SM - Distributor



1084827

<https://www.phoenixcontact.com/pc/products/1084827>

Please be informed that the data shown in this PDF document is generated from our online catalog. Please find the complete data in the user documentation. Our general terms of use for downloads are valid.



Distributor, design: Rail-mountable module, degree of protection: IP20, material: Metal, connection method: Splicing, cable outlet: above and below, housing size: 1, color: gray

Product description

FDX 20 series DIN rail splice box, equipped with 6x SC duplex couplings, splice holder (for separately sold shrink and crimp splice protection) on a patented splice comb made from powder-coated sheet steel. Cable insertion possible via cable gland either at the top or bottom. Housing (2-part) prepared for DIN rail mounting through rear-side adapter (this can also be mounted on the side).

Scope of supply:

DIN rail housing with integrated splice comb (mounted), equipped with 6x SC duplex couplings, 1x splice holder, 1x cable gland (M20x1.5)

Your advantages

- Intuitive front-panel operation and clear control cabinet layout thanks to uniform design
- Flexible DIN rail mounting possible in six positioning directions
- Suitable for industrial applications
- Reduced installation time with plug-and-play
- Pin assignment straight in line in a link
- Continuously reliable data connection, thanks to extensively tested components
- Snap-on mounting on standard NS 35/7,5 or NS 35/15 DIN rails
- Transmission rate up to 1000 Mbps

Commercial data

Item number	1084827
Packing unit	1 pc
Minimum order quantity	1 pc
Product key	ABNGAB
GTIN	4055626823881
Weight per piece (including packing)	722.6 g
Weight per piece (excluding packing)	577 g
Customs tariff number	85367000
Country of origin	DE

1084827

<https://www.phoenixcontact.com/pc/products/1084827>

Technical data

Notes

General	Wire pigtails must be ordered separately
---------	--

Product properties

Product type	Network distributor box
Series	FDX 20 series
Type	Rail-mountable module
Connection profile	SC-Duplex
No. of cable outlets	2
Number of module slots	6
Number of slots	12
Type of the screw connection	M20 x 1.5
Housing type	DIN rail adapter
Protective cover	yes
Cable outlet	above and below

Electrical properties

Transmission medium	FO
---------------------	----

Connection data

Connection technology

Connection method	Splicing
-------------------	----------

Dimensions

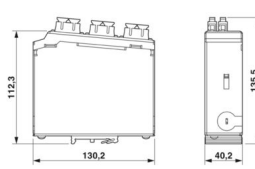
Dimensional drawing	
Width	40 mm
Height	130 mm
Depth	115 mm

Housing

Housing width	40 mm
---------------	-------

Mechanical characteristics

Ferrule diameter	2.50 mm
------------------	---------

Material specifications

Color	gray
Flammability rating according to UL 94	V0

1084827

<https://www.phoenixcontact.com/pc/products/1084827>

Ferrule material	Zirconia ceramics
Housing material	Metal
Housing surface material	Powder-coated, gray

Cable/line

Cable type	Fiberglass
External cable diameter ()	6 mm ... 12 mm
External cable diameter	≤ 12.00 mm (of 6 mm) 6 mm ... 12 mm
Wire diameter incl. insulation	900 µm
Resistance to oil	no
Flame resistance	yes

FO cable

Fiber	GOF
Fiber type	Single-mode fiberglass
Transmission medium	FO

Mechanical properties

Mechanical data

Type of the screw connection	M20 x 1.5
Insertion/withdrawal cycles	≥ 500

Environmental and real-life conditions

Ambient conditions

Degree of protection	IP20 (according to IEC 60529) IP20
Ambient temperature (operation)	-40 °C ... 85 °C (Category OPhd+)
Ambient temperature (storage/transport)	-40 °C ... 85 °C
Ambient temperature (assembly)	0 °C ... 50 °C
Resistance to oil	no

Standards and regulations

Flame resistance	yes
Resistance to oil	no

Mounting

Mounting type	DIN rail mounting
Assembly instructions	Option for flexible replugging of DIN rail adapter

FOC-FDX20-PP-SCD6-SM - Distributor



1084827

<https://www.phoenixcontact.com/pc/products/1084827>

Drawings

Dimensional drawing

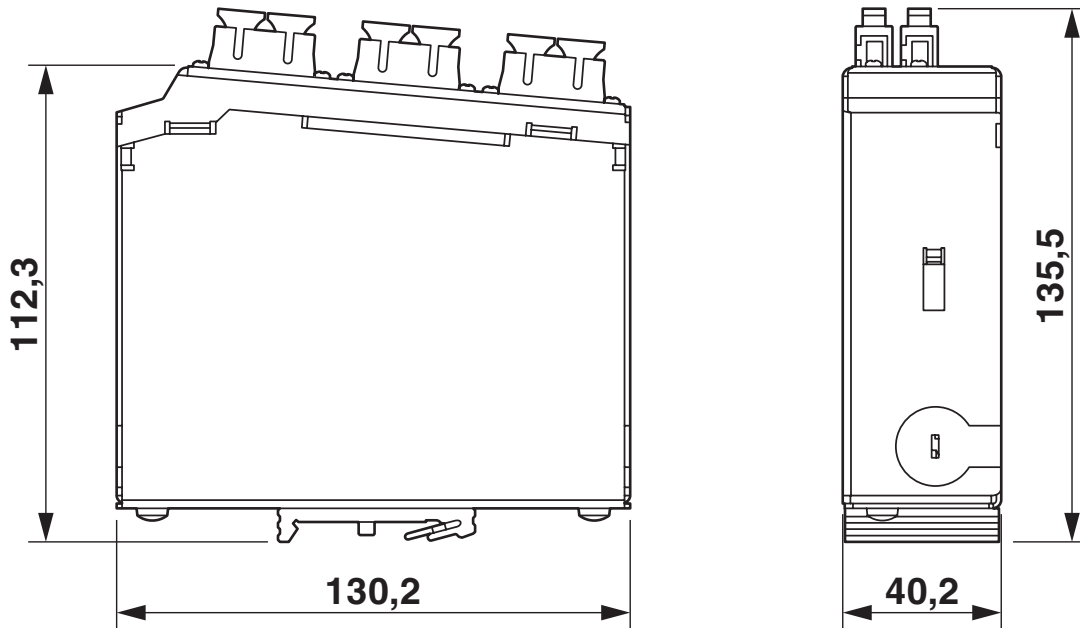

DIN rail distributor 6x SC duplex

1084827

<https://www.phoenixcontact.com/pc/products/1084827>

Classifications

ECLASS

ECLASS-11.0	19170113
ECLASS-12.0	19170113
ECLASS-13.0	19170113

ETIM

ETIM 8.0	EC002699
----------	----------

UNSPSC

UNSPSC 21.0	43223300
-------------	----------

1084827

<https://www.phoenixcontact.com/pc/products/1084827>

Environmental product compliance

EU RoHS

Fulfills EU RoHS substance requirements	Yes, No exemptions
---	--------------------

China RoHS

Environment friendly use period (EFUP)	EFUP-E
	No hazardous substances above the limits

EU REACH SVHC

REACH candidate substance (CAS No.)	No substance above 0.1 wt%
-------------------------------------	----------------------------

1084827

<https://www.phoenixcontact.com/pc/products/1084827>

Mandatory accessories

FOC-SHRINKSPLICE-PROTECT - Shrink splice protection

1019676

<https://www.phoenixcontact.com/pc/products/1019676>



Shrink splice protection, design: Straight, degree of protection: IP20, cable outlet: above and below, color: transparent

FOC-CRIMPSPLICE-PROTECT - Crimp splice protection

1019678

<https://www.phoenixcontact.com/pc/products/1019678>



Crimp splice protection, design: Straight, degree of protection: IP20, connection method: Crimp connection, cable outlet: above and below, color: Bare metallic

Accessories

FOC-FDX20-PP-SCD6-SM - Distributor

1084827

<https://www.phoenixcontact.com/pc/products/1084827>

FOC-SC:PA-SC:PA-OS2:D01/1 - FO patch cable

1115550

<https://www.phoenixcontact.com/pc/products/1115550>

Single-mode OS2 duplex jumper, SC-SC, UPC polishing, length 1 m

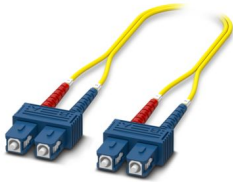

FOC-SC:PA-SC:PA-OS2:D01/2 - FO patch cable

1115548

<https://www.phoenixcontact.com/pc/products/1115548>

Single-mode OS2 duplex jumper, SC-SC, UPC polishing, length 2 m

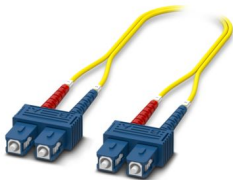

FOC-FDX20-PP-SCD6-SM - Distributor

1084827

<https://www.phoenixcontact.com/pc/products/1084827>

FOC-SC:PA-SC:PA-OS2:D01/5 - FO patch cable

1115546

<https://www.phoenixcontact.com/pc/products/1115546>

Single-mode OS2 duplex jumper, SC-SC, UPC polishing, length 5 m

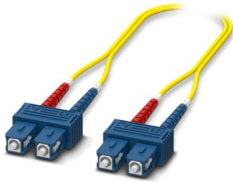

FOC-ST:PA-SC:PA-OS2:D01/1 - FO patch cable

1115582

<https://www.phoenixcontact.com/pc/products/1115582>

Single-mode OS2 duplex jumper, ST-SC, UPC polishing, length 1 m

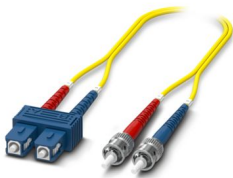

FOC-FDX20-PP-SCD6-SM - Distributor



1084827

<https://www.phoenixcontact.com/pc/products/1084827>

FOC-ST:PA-SC:PA-OS2:D01/2 - FO patch cable

1115581

<https://www.phoenixcontact.com/pc/products/1115581>

Single-mode OS2 duplex jumper, ST-SC, UPC polishing, length 2 m

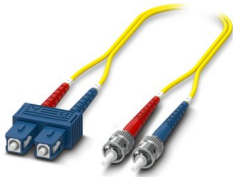

FOC-ST:PA-SC:PA-OS2:D01/5 - FO patch cable

1115579

<https://www.phoenixcontact.com/pc/products/1115579>

Single-mode OS2 duplex jumper, ST-SC, UPC polishing, length 5 m

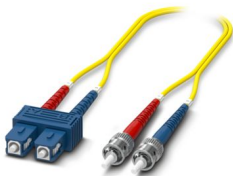

FOC-FDX20-PP-SCD6-SM - Distributor

1084827

<https://www.phoenixcontact.com/pc/products/1084827>

FOC-LC:PA-SC:PA-OS2:D01/1 - FO patch cable

1115618

<https://www.phoenixcontact.com/pc/products/1115618>

Single-mode OS2 duplex jumper, LC-SC, UPC polishing, length 1 m

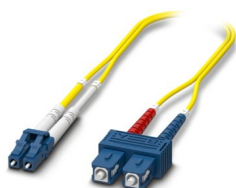

FOC-LC:PA-SC:PA-OS2:D01/2 - FO patch cable

1115617

<https://www.phoenixcontact.com/pc/products/1115617>

Single-mode OS2 duplex jumper, LC-SC, UPC polishing, length 2 m

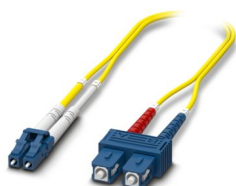

FOC-FDX20-PP-SCD6-SM - Distributor



1084827

<https://www.phoenixcontact.com/pc/products/1084827>

FOC-LC:PA-SC:PA-OS2:D01/5 - FO patch cable

1115615

<https://www.phoenixcontact.com/pc/products/1115615>

Single-mode OS2 duplex jumper, LC-SC, UPC polishing, length 5 m

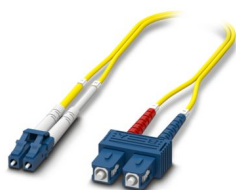

FOC-PT9:SC-OSP/2.5 - Fiber optic cable

1208113

<https://www.phoenixcontact.com/pc/products/1208113>

Fiber optic cable, design: SC, degree of protection: IP20, cable length: 2.5 m, number of positions: 12, 100 Gbps, material: Plastic, connection method: SC, cable outlet: straight, color: blue

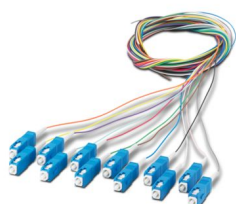

FOC-FDX20-PP-SCD6-SM - Distributor

1084827

<https://www.phoenixcontact.com/pc/products/1084827>

FOC-PT9:SC-OSA/2.5 - Fiber optic cable

1208114

<https://www.phoenixcontact.com/pc/products/1208114>

Fiber optic cable, design: SC, degree of protection: IP20, cable length: 2.5 m, number of positions: 12, 100 Gbps, connection method: SC, cable outlet: straight, color: green



FOC-OE-OE-GL-U-OS2-12/... - FO cable

1286219

<https://www.phoenixcontact.com/pc/products/1286219>

GOF universal cable, 12-wire, loose tube cable for fixed installation, non-metallic rodent protection, can be easily stripped, UV-resistant, high mechanical and thermal stability, low smoke, halogen-free and self-extinguishing, improved tread resistance, longitudinally and transversely watertight



FOC-FDX20-PP-SCD6-SM - Distributor



1084827

<https://www.phoenixcontact.com/pc/products/1084827>

FOC-TOOL-FERRULECLEANER-2.50 - FO accessories

1407029

<https://www.phoenixcontact.com/pc/products/1407029>

2.50 mm ferrule cleaner, for ST, SC, FC, E2000 (also APC), approx. 500 cleaning cycles



FOC-TOOL-STICKCLEANER-2.50 - FO accessories

1407002

<https://www.phoenixcontact.com/pc/products/1407002>

Stick cleaner for couplings and plug end faces, 2.50 mm (ST, SC), Pcs. / Pkt.: 10



1084827

<https://www.phoenixcontact.com/pc/products/1084827>

A-INSP-M20-68N-P-LG - Screw plug

1424519

<https://www.phoenixcontact.com/pc/products/1424519>

Screw plug, material for screw connection: PA, connecting thread: M20 x 1.5, color: lightgrey RAL 7035, with O-ring



WP-CN PA M20 - Counter nut

3241134

<https://www.phoenixcontact.com/pc/products/3241134>

Counter nut, for threads M20, color: gray



1084827

<https://www.phoenixcontact.com/pc/products/1084827>

SF-PH 1-80 - Screwdriver

1212559

<https://www.phoenixcontact.com/pc/products/1212559>



Screwdriver, PH crosshead (lasered), uninsulated, size: PH 1 x 80, 2-component grip, with non-slip grip

SF-SL 1,0X5,5-150 - Screwdriver

1212552

<https://www.phoenixcontact.com/pc/products/1212552>



Screwdriver, bladed (lasered), size: 1.0 x 5.5 x 150 mm, 2-component grip, with non-slip grip

1084827

<https://www.phoenixcontact.com/pc/products/1084827>

E/NS 35 N - End bracket

0800886

<https://www.phoenixcontact.com/pc/products/0800886>

End clamp, width: 9.5 mm, color: gray

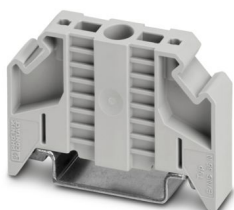

NBC-PP-G1PGY - DIN rail adapter

1041740

<https://www.phoenixcontact.com/pc/products/1041740>

DIN rail adapter, design: Headers with shielding, degree of protection: IP20, material: PC-GF10, connection method: Quick connection, without assembled modules



FOC-FDX20-PP-SCD6-SM - Distributor



1084827

<https://www.phoenixcontact.com/pc/products/1084827>

FL DIN RA - DIN rail adapter

2891053

<https://www.phoenixcontact.com/pc/products/2891053>

The FL DIN RA is installed in a standard, 19-inch rack (EIA-310-D, IEC 60297-3-100) to allow DIN rail mounted equipment to be rack mounted.



G-INS-M20-S68N-PNES-GY - Cable gland

1411125

<https://www.phoenixcontact.com/pc/products/1411125>

Cable gland, material for screw connection: PA, external cable diameter 6 mm ... 12 mm, shielding: no, connecting thread: M20 x 1.5, color: silver-grey RAL 7001



1084827

<https://www.phoenixcontact.com/pc/products/1084827>

TML (104X10)R - Marker strip

0801835

<https://www.phoenixcontact.com/pc/products/0801835>



Marker strip, Roll, white, unlabeled, can be labeled with: THERMOMARK E.300 (D)/600 (D), THERMOMARK ROLL 2.0, THERMOMARK ROLL, THERMOMARK ROLL X1, THERMOMARK ROLLMASTER 300/600, THERMOMARK X1.2, mounting type: adhesive, for terminal block width: 104 mm, lettering field size: 104 x 10 mm, Number of individual labels: 1500

TML (EX9,5)R TR - Marker strip

0816634

<https://www.phoenixcontact.com/pc/products/0816634>



Marker strip, Roll, transparent, unlabeled, can be labeled with: THERMOMARK E.300 (D)/600 (D), THERMOMARK ROLL 2.0, THERMOMARK ROLL, THERMOMARK ROLL X1, THERMOMARK ROLLMASTER 300/600, THERMOMARK X1.2, mounting type: adhesive, for terminal block width: 30000 mm, lettering field size: 40000 x 9.5 mm, Number of individual labels: 1

1084827

<https://www.phoenixcontact.com/pc/products/1084827>

EMLS (70X32)R SR - Safety label with special adhesive

0800346

<https://www.phoenixcontact.com/pc/products/0800346>



Safety label with special adhesive, Roll, silver, unlabeled, can be labeled with: THERMOMARK E.300 (D)/600 (D), THERMOMARK ROLL 2.0, THERMOMARK ROLL, THERMOMARK ROLL X1, THERMOMARK ROLLMASTER 300/600, THERMOMARK X1.2, mounting type: adhesive, lettering field size: 70 x 32 mm, Number of individual labels: 500

EML-HA (76X51)R - Label for rough surfaces

0830609

<https://www.phoenixcontact.com/pc/products/0830609>



Label for rough surfaces, Roll, white, unlabeled, can be labeled with: THERMOMARK E.300 (D)/600 (D), THERMOMARK ROLL 2.0, THERMOMARK ROLL, THERMOMARK ROLL X1, THERMOMARK ROLLMASTER 300/600, THERMOMARK X1.2, mounting type: adhesive, lettering field size: 76 x 51 mm, Number of individual labels: 1000

1084827

<https://www.phoenixcontact.com/pc/products/1084827>

PML-W100 (25X25)R - Warning label

0830429

<https://www.phoenixcontact.com/pc/products/0830429>



Warning label, Roll, yellow/black, unlabeled, can be labeled with: THERMOMARK E.300 (D)/600 (D), THERMOMARK ROLL 2.0, THERMOMARK ROLL, THERMOMARK ROLL X1, THERMOMARK ROLLMASTER 300/600, THERMOMARK X1.2, mounting type: adhesive, diameter: 0 mm, lettering field size: 25 x 25 mm, Number of individual labels: 500

LS-EMLP (60X15) WH - Device marker

0831696

<https://www.phoenixcontact.com/pc/products/0831696>



Device marker, Sheet, white, unlabeled, can be labeled with: TOPMARK NEO, TOPMARK LASER, mounting type: adhesive, lettering field size: 60 x 15 mm, Number of individual labels: 20

FOC-FDX20-PP-SCD6-SM - Distributor



1084827

<https://www.phoenixcontact.com/pc/products/1084827>

WML-RFID/HF 14 (25X19)R - Cable marker

0803386

<https://www.phoenixcontact.com/pc/products/0803386>



Cable marker label with RFID-HF transponder, roll, white, unmarked, can be printed with: THERMOMARK ROLL, THERMOMARK ROLL X1, THERMOMARK X1.2, mounting type: adhesive, min. cable diameter: 9 mm, max. cable diameter: 14 mm, lettering field size: 25 x 19 mm

Phoenix Contact 2024 © - all rights reserved

<https://www.phoenixcontact.com>

PHOENIX CONTACT GmbH & Co. KG

Flachsmarktstraße 8

D-32825 Blomberg

+49 (0) 5235-3 00

info@phoenixcontact.com