

ICS25-TL100X12-7035 - Upper housing part



2203883

<https://www.phoenixcontact.com/us/products/2203883>

Please be informed that the data shown in this PDF document is generated from our online catalog. Please find the complete data in the user documentation. Our general terms of use for downloads are valid.

DIN rail housing, Upper part, with transparent hinged cover, width: 25 mm, height: 101 mm, depth: 14.35 mm, color: light grey (similar RAL 7035)



Your advantages

- Flexible use, thanks to the modular system and unique modularity in the connection technology
- Standardized connections such as RJ45, USB, D-SUB and antenna sockets as components that can be integrated
- Optimal space utilization, as well as adaptability of design, colors, and printing
- Eight-position DIN rail connectors with parallel and up to two serial contacts for easy module-to-module communication

Commercial data

Item number	2203883
Packing unit	10 pc
Minimum order quantity	10 pc
Sales key	AC09
Product key	ACHAEC
GTIN	4055626465586
Weight per piece (including packing)	16.04 g
Weight per piece (excluding packing)	12.4 g
Customs tariff number	85389099
Country of origin	DE

ICS25-TL100X12-7035 - Upper housing part

2203883

<https://www.phoenixcontact.com/us/products/2203883>

Technical data

Notes

General	Refer to the data sheet for the range in the download area.
---------	---

Product properties

Product type	Upper housing part
Housing series	ICS
Product family	ICS25-..100X..
Type	Upper part, with transparent hinged cover
Housing type	DIN rail housing
Ventilation openings present	no

Dimensions

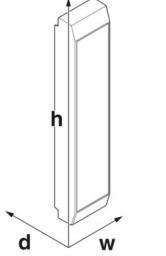
Dimensional drawing	
Width	25 mm
Height	101 mm
Depth	14.35 mm

PCB design

PCB thickness	1.4 mm ... 1.8 mm
---------------	-------------------

Material specifications

Color (Upper housing part)	light grey (RAL 7035)
Color (Housing cover)	transparent
Flammability rating according to UL 94	V0
CTI according to IEC 60112	600
Surface characteristics	untreated
Housing material	Polyamide

Environmental and real-life conditions

Vibration test

Specification	IEC 60068-2-6:2007-12
Frequency	10 - 150 - 10 Hz
Sweep speed	1 octave/min
Amplitude	0.15 mm (10 Hz ... 58.1 Hz)

ICS25-TL100X12-7035 - Upper housing part



2203883

<https://www.phoenixcontact.com/us/products/2203883>

Acceleration	2g (58.1 Hz ... 150 Hz)
Test duration per axis	2.5 h
Test directions	X-, Y- and Z-axis

Glow-wire test

Specification	IEC 60695-2-11:2014-02
Temperature	850 °C
Time of exposure	30 s

Thermal stability / ball thrust test

Specification	IEC 60695-10-2:2014-02
Temperature	125 °C
Test duration	1 h
Force	20 N

Mechanical strength / tumbling barrel

Specification	IEC 60068-2-31:2008-05
Height of fall	50 cm
Frequency	50

Shocks

Specification	IEC 60068-2-27:2008-02
Pulse shape	Semi-sinusoidal
Acceleration	15g
Shock duration	11 ms
Number of shocks per direction	3
Test directions	X-, Y- and Z-axis (pos. and neg.)

Test for substances that would hinder coating with paint or varnish

Specification	VDMA 24364:2018-05
Result	Test passed

Degree of protection (IP code)

Specification	IEC 60529:1989-11 + AMD 1:1999-11 + AMD 2:2013-08
Result, degree of protection, IP code	IP20

Protection against electric shock

Specification	IEC 60998-1:2002-12
Requirements, protection against electric shock	It must not be possible to touch any conductive part with the IEC test finger and a test force of 10 N.

Ambient conditions

Max. IP code to attain	IP20
Ambient temperature (operation)	-40 °C ... 105 °C (depending on power dissipation)
Ambient temperature (storage/transport)	-40 °C ... 55 °C
Ambient temperature (assembly)	-5 °C ... 100 °C
Relative humidity (storage/transport)	80 %

ICS25-TL100X12-7035 - Upper housing part



2203883

<https://www.phoenixcontact.com/us/products/2203883>

PCB data

Number of PCB holders	2
Type of PCB mount	Slot
Thickness of the PCB	1.4 mm ... 1.8 mm

Mounting

Mounting type	Snap in
Mounting position	Vertical (horizontal DIN rail)

Packaging specifications

Type of packaging	packed in cardboard
Outer packaging type	Carton

ICS25-TL100X12-7035 - Upper housing part



2203883

<https://www.phoenixcontact.com/us/products/2203883>

Classifications

ECLASS

ECLASS-11.0	27182702
ECLASS-13.0	27190603

ETIM

ETIM 9.0	EC001031
----------	----------

UNSPSC

UNSPSC 21.0	31261500
-------------	----------

ICS25-TL100X12-7035 - Upper housing part



2203883

<https://www.phoenixcontact.com/us/products/2203883>

Environmental product compliance

China RoHS	Environmentally friendly use period: unlimited = EFUP-e No hazardous substances above threshold values
------------	---

Phoenix Contact 2024 © - all rights reserved
<https://www.phoenixcontact.com>

Phoenix Contact USA
586 Fulling Mill Road
Middletown, PA 17057, United States
(+717) 944-1300
info@phoenixcon.com