

FBP 7+1 - Blind plug

3069400

<https://www.phoenixcontact.com/us/products/3069400>

Please be informed that the data shown in this PDF document is generated from our online catalog. Please find the complete data in the user documentation. Our general terms of use for downloads are valid.

Blind plug, number of positions: 8, color: orange



Your advantages

- Blind plug for FAME..., serves as a protective cover for the test block when the power plug is unplugged

Commercial data

Item number	3069400
Packing unit	5 pc
Minimum order quantity	5 pc
Product key	BE6111
Catalog page	Page 615 (C-1-2019)
GTIN	4055626348605
Weight per piece (including packing)	80.3 g
Weight per piece (excluding packing)	80.3 g
Country of origin	PL

FBP 7+1 - Blind plug

3069400

<https://www.phoenixcontact.com/us/products/3069400>

Technical data

Product properties

Product type	Blind plug
Number of positions	8
Pitch	8.2 mm

Dimensions

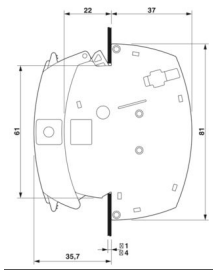
Dimensional drawing	
Width	99 mm
Height	72.9 mm
Pitch	8.2 mm

Material specifications

Color	orange
Flammability rating according to UL 94	V0
Insulating material	PA

Environmental and real-life conditions

Ambient conditions

Ambient temperature (operation)	-60 °C ... 105 °C (max. short-term operating temperature RTI Elec.)
Ambient temperature (storage/transport)	-25 °C ... 60 °C (for a short time, not exceeding 24 h, -60 °C to +70 °C)
Ambient temperature (assembly)	-5 °C ... 70 °C
Ambient temperature (actuation)	-5 °C ... 70 °C
Permissible humidity (storage/transport)	30 % ... 70 %

FBP 7+1 - Blind plug

3069400

<https://www.phoenixcontact.com/us/products/3069400>



Classifications

ECLASS

ECLASS-13.0	27440313
ECLASS-12.0	27440313
ECLASS-11.0	27440313

ETIM

ETIM 9.0	EC002255
----------	----------

UNSPSC

UNSPSC 21.0	20122000
-------------	----------

FBP 7+1 - Blind plug

3069400

<https://www.phoenixcontact.com/us/products/3069400>



Environmental product compliance

China RoHS	Environmentally friendly use period: unlimited = EFUP-e No hazardous substances above threshold values
------------	---

Phoenix Contact 2024 © - all rights reserved
<https://www.phoenixcontact.com>

Phoenix Contact USA
586 Fulling Mill Road
Middletown, PA 17057, United States
(+717) 944-1300
info@phoenixcon.com