

## Digital display - FA MCR-FD-TUI-UI-2REL-UP - 2907780

Please be informed that the data shown in this PDF Document is generated from our Online Catalog. Please find the complete data in the user's documentation. Our General Terms of Use for Downloads are valid (<http://phoenixcontact.com/download>)



Multifunctional process indicator in field housing for monitoring and displaying analog measurement data. Universal inputs permit connection of current, voltage, RTDs, and TCs. Two relay change-over contact outputs and one analog output.

### Product Description

Multifunctional process indicator in field housing for monitoring and displaying analog measurement data. Dual-conductor sensors can be powered with the integrated measuring transducer supply. Universal inputs permit connection of current, voltage, RTDs, and TCs. Limit values can be monitored and relays can be switched. The analog output allows you to transmit process signals. A color change in the event of a fault supports the detection of alarm conditions. 5-digit, 7-segment LC display, with backlight, 1 universal input, 2 relays, min./max. value memory, linearization table, digital status output (open collector)



### Key Commercial Data

Packing unit	1 pc
GTIN	 4 055626 232140
GTIN	4055626232140
Weight per Piece (excluding packing)	1,420.000 g
Custom tariff number	90291000
Country of origin	Germany

### Technical data

#### Dimensions

Width	199 mm
Height	160 mm
Depth	96 mm

#### Ambient conditions

Ambient temperature (operation)	-40 °C ... 50 °C (The readability of the display is no longer guaranteed at temperatures below -30 °C (-22 °F).)
---------------------------------	--

## Digital display - FA MCR-FD-TUI-UI-2REL-UP - 2907780

### Technical data

#### Ambient conditions

Ambient temperature (storage/transport)	-40 °C ... 85 °C
Maximum altitude	< 2000 m (Above sea level)
Permissible humidity (operation)	condensation permitted
Degree of protection	IP67
Noise immunity	IEC 61326 / NAMUR NE 21

#### Input data

Description of the input	Universal input
Number of inputs	1
Current input signal	0 mA ... 20 mA +10 % 4 mA ... 20 mA +10 %
Max. input current	< 150 mA
Input signal	Current
Input resistance current input	10 Ω
Transmitter supply voltage	> 16 V (22 mA)
Transmitter supply voltage range	22.8 V ... 27.6 V (No-load)
Transmitter supply current	< 30 mA (Short-circuit and overload protection)
Available input sources	Resistance thermometers
Sensor types (RTD) that can be used	Pt, Ni, Cu sensors
Connection technology	2-, 3-, 4-conductor
Description of the input	Universal input
Voltage input signal	0 V ... 10 V 2 V ... 10 V 0 V ... 5 V 0 V ... 1 V 1 V ... 5 V -1 V ... 1 V -10 V ... 10 V -30 V ... 30 V -100 mV ... 100 mV
max. input voltage	± 35 V (≥ 1 V)
Input signal	Voltage
Input resistance of voltage input	> 1 MΩ
Available input sources	Thermocouples
Sensor types that can be used (TC)	J, K, T, N, B, S, R, U, L, C, D

#### Output data

Output name	Current output
-------------	----------------

## Digital display - FA MCR-FD-TUI-UI-2REL-UP - 2907780

### Technical data

#### Output data

Number of outputs	1
Configurable/programmable	Yes
Current output signal	0 mA ... 20 mA
	4 mA ... 20 mA
Max. output current	< 22 mA
Load/output load current output	≤ 500 Ω (22 mA)
Ripple	< 10 mV <sub>PP</sub> (500 Ω)
D/A converter resolution	13 bit
Output name	Voltage output
Voltage output signal	0 V ... 10 V
	2 V ... 10 V
	0 V ... 5 V
	1 V ... 5 V
Max. output voltage	< 11 V
Ripple	< 10 mV <sub>PP</sub> (1000 Ω)
D/A converter resolution	13 bit

#### Switching output

Output name	Relay output
Contact type	2 changeover contacts
Minimum switching voltage	12 V
Maximum switching voltage	30 V DC (3 A)
	230 V AC (3 A)
Min. switching current	10 mA
Output name	Transistor output, active
Output description	Open collector output
Number of outputs	1
Contact type	Transistor
Maximum switching voltage	28 V
Max. switching current	3 A
	200 mA

#### Power supply

Supply voltage range	24 V AC/DC ... 230 V AC/DC (-20 % ... +10 %, 50 Hz ... 60 Hz)
Power consumption	≤ 6.9 W

#### Connection data

Connection name	Input, output, status, relay
Connection method	Spring-cage connection

## Digital display - FA MCR-FD-TUI-UI-2REL-UP - 2907780

### Technical data

#### Connection data

Stripping length	10 mm
Conductor cross section solid	0.2 mm <sup>2</sup> ... 2.5 mm <sup>2</sup>
Conductor cross section flexible	0.2 mm <sup>2</sup> ... 2.5 mm <sup>2</sup>
Conductor cross section AWG	24 ... 14

#### General

Test voltage	2500 V
Test voltage input/output	500 V
Test voltage input/power supply	2500 V
Test voltage output/power supply	2500 V
Noise emission	IEC 61326, class A
Noise immunity	IEC 61326 / NAMUR NE 21
Housing material	PBT GF30
Mounting position	Max. viewing angle range +/- 45° from the centre line of the display in every direction

#### Standards and Regulations

Noise emission	IEC 61326, class A
Noise immunity	IEC 61326 / NAMUR NE 21
Conformance	CE-compliant
UL, USA/Canada	UL 61010 Recognized
CSA	CSA GP

#### Environmental Product Compliance

China RoHS	Environmentally Friendly Use Period = 50 years
	For details about hazardous substances go to tab "Downloads", Category "Manufacturer's declaration"

### Drawings

# Digital display - FA MCR-FD-TUI-UI-2REL-UP - 2907780

Block diagram

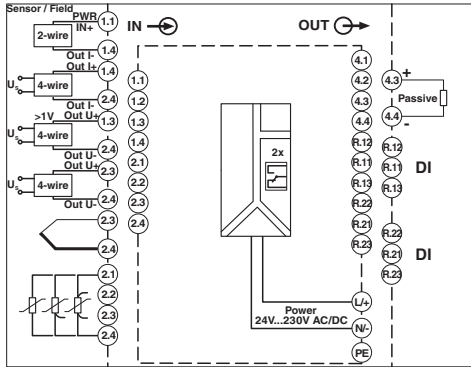

Pictogram

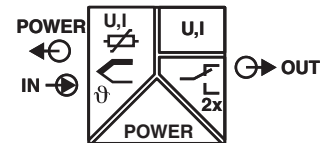

Block diagram FA MCR-FD-TUI-UI-2REL-UP

## Classifications

eCl@ss

eCl@ss 10.0.1	27210301
eCl@ss 11.0	27210301
eCl@ss 4.0	27210300
eCl@ss 4.1	27210300
eCl@ss 5.0	27210300
eCl@ss 5.1	27210300
eCl@ss 6.0	27210300
eCl@ss 7.0	27210301
eCl@ss 9.0	27210301

ETIM

ETIM 2.0	EC001426
ETIM 3.0	EC001426
ETIM 4.0	EC001426
ETIM 6.0	EC001426
ETIM 7.0	EC001426

UNSPSC

UNSPSC 13.2	39121522
UNSPSC 18.0	39121008
UNSPSC 19.0	39121008
UNSPSC 20.0	39121008
UNSPSC 21.0	39121008

# Digital display - FA MCR-FD-TUI-UI-2REL-UP - 2907780

## Approvals

### Approvals

---

#### Approvals





CSA / UL Recognized / cUL Recognized / EAC / cULus Recognized

---

#### Ex Approvals

---

### Approval details

CSA		<a href="http://www.csagroup.org/services-industries/product-listing/">http://www.csagroup.org/services-industries/product-listing/</a>	2879105
UL Recognized		<a href="http://database.ul.com/cgi-bin/XYV/template/LISEXT/1FRAME/index.htm">http://database.ul.com/cgi-bin/XYV/template/LISEXT/1FRAME/index.htm</a>	FILE E 198586
cUL Recognized		<a href="http://database.ul.com/cgi-bin/XYV/template/LISEXT/1FRAME/index.htm">http://database.ul.com/cgi-bin/XYV/template/LISEXT/1FRAME/index.htm</a>	FILE E 198586
EAC			RU*DE.*08.B.01861/19
cULus Recognized			

---