

HSCP-SP 2,5-1U4-7035 - Printed-circuit board connector



2201780

<https://www.phoenixcontact.com/us/products/2201780>

Please be informed that the data shown in this PDF document is generated from our online catalog. Please find the complete data in the user documentation. Our general terms of use for downloads are valid.



PCB connector, nominal cross section: 2.5 mm², color: light grey, nominal current: 8 A, rated voltage (III/2): 320 V, contact surface: Tin, contact connection type: Socket, number of potentials: 4, number of rows: 2, number of positions: 4, number of connections: 4, product range: HSCP-SP 2,5-..., pitch: 5 mm, connection method: Push-in spring connection, conductor/PCB connection direction: 0 °, locking clip: - Locking clip, plug-in system: HSC 2,5, locking: without, mounting: without, type of packaging: packed in cardboard, Color of the spring lever: orange

Your advantages

- Time saving push-in connection, tools not required
- Defined contact force ensures that contact remains stable over the long term
- Intuitive operation due to color-coded actuating push button
- Operation and conductor connection from one direction enable integration into front of device
- Quick and convenient testing using integrated test option
- User-friendly front connection plug for high contact densities

Commercial data

Item number	2201780
Packing unit	50 pc
Minimum order quantity	50 pc
Sales key	AC15
Product key	ACHECB
Catalog page	Page 35 (NTK-2014)
GTIN	4046356911436
Weight per piece (including packing)	3.426 g
Weight per piece (excluding packing)	3.426 g
Customs tariff number	85366990
Country of origin	PL

HSCP-SP 2,5-1U4-7035 - Printed-circuit board connector



2201780

<https://www.phoenixcontact.com/us/products/2201780>

Technical data

Product properties

Product type	PCB connector
Product family	HSCP-SP 2,5-..
Number of positions	4
Pitch	5 mm
Number of connections	4
Number of rows	2
Number of potentials	4

Electrical properties

Nominal current I_N	8 A
Nominal voltage U_N	320 V
Degree of pollution	3
Rated voltage (III/3)	250 V
Rated surge voltage (III/3)	4 kV
Rated voltage (III/2)	320 V
Rated surge voltage (III/2)	4 kV
Rated voltage (II/2)	600 V
Rated surge voltage (II/2)	4 kV

Connection data

Connection technology

Connector system	HSC 2,5
Nominal cross section	2.5 mm ²
Contact connection type	Socket

Interlock

Locking type	without
Mounting flange	without

Conductor connection

Connection method	Push-in spring connection
Conductor/PCB connection direction	0 °
Conductor cross section rigid	0.2 mm ² ... 1.5 mm ²
Conductor cross section flexible	0.2 mm ² ... 2.5 mm ²
Conductor cross section AWG	24 ... 16
Conductor cross section flexible, with ferrule without plastic sleeve	0.25 mm ² ... 1.5 mm ²
Conductor cross section, flexible, with ferrule, with plastic sleeve	0.25 mm ² ... 1.5 mm ²
Cylindrical gauge a x b / diameter	2.4 mm x 1.5 mm / 1.9 mm
Stripping length	10 mm

HSCP-SP 2,5-1U4-7035 - Printed-circuit board connector

2201780

<https://www.phoenixcontact.com/us/products/2201780>

Material specifications

Material data - contact

Note	WEEE/RoHS-compliant, free of whiskers according to IEC 60068-2-82/JEDEC JESD 201
Contact material	Cu alloy
Surface characteristics	Tin-plated

Material data - housing

Color (Housing)	light grey (7035)
Insulating material	PA
Insulating material group	I
CTI according to IEC 60112	600
Flammability rating according to UL 94	V0
Glow wire flammability index GWFI according to EN 60695-2-12	850
Glow wire ignition temperature GWIT according to EN 60695-2-13	775
Temperature for the ball pressure test according to EN 60695-10-2	125 °C

Material data – actuating element

Insulating material	PBT
Insulating material group	IIIa
CTI according to IEC 60112	275
Flammability rating according to UL 94	V0

Dimensions

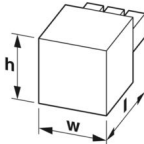
Dimensional drawing	
Pitch	5 mm
Width [w]	18.8 mm
Height [h]	10.9 mm
Length [l]	21.6 mm

Mounting

Processing notes

Moisture Sensitive Level	MSL 1
Classification temperature T _c	260 °C
Solder cycles in the reflow	3

Notes

Assembly instruction:	Refer to the data sheet for the range in the download area.
-----------------------	---

HSCP-SP 2,5-1U4-7035 - Printed-circuit board connector



2201780

<https://www.phoenixcontact.com/us/products/2201780>

Safety note

Safety note	WARNING: The connectors may not be plugged in or disconnected under load. Ignoring the warning or improper use may damage persons and/or property.
	• WARNING: Commission properly functioning products only. The products must be regularly inspected for damage. Decommission defective products immediately. Replace damaged products. Repairs are not possible.
	• WARNING: Only electrically qualified personnel may install and operate the product. They must observe the following safety notes. The qualified personnel must be familiar with the basics of electrical engineering. They must be able to recognize and prevent danger. The relevant symbol on the packaging indicates that only personnel familiar with electrical engineering are allowed to install and operate the product.
	• The item is intended to be an unencapsulated plug for installation in a housing.
	• Operate the connector only when it is fully plugged in.

Environmental and real-life conditions

Ambient conditions

Ambient temperature (operation)	-40 °C ... 105 °C (dependent on the derating curve)
Ambient temperature (storage/transport)	-40 °C ... 55 °C
Relative humidity (storage/transport)	30 % ... 70 %
Ambient temperature (assembly)	-5 °C ... 100 °C

Electrical tests

Air clearances and creepage distances |

Specification	IEC 60664-1:2007-04
Insulating material group	I
Comparative tracking index (IEC 60112)	CTI 600
Rated insulation voltage (III/3)	250 V
Rated surge voltage (III/3)	4 kV
minimum clearance value - non-homogenous field (III/3)	3 mm
minimum creepage distance (III/3)	3.2 mm
Rated insulation voltage (III/2)	320 V
Rated surge voltage (III/2)	4 kV
minimum clearance value - non-homogenous field (III/2)	3 mm
minimum creepage distance (III/2)	3 mm
Rated insulation voltage (II/2)	600 V
Rated surge voltage (II/2)	4 kV
minimum clearance value - non-homogenous field (II/2)	3 mm
minimum creepage distance (II/2)	3.2 mm

Packaging specifications

Type of packaging	packed in cardboard
-------------------	---------------------

HSCP-SP 2,5-1U4-7035 - Printed-circuit board connector



2201780

<https://www.phoenixcontact.com/us/products/2201780>

Outer packaging type	Carton
----------------------	--------

HSCP-SP 2,5-1U4-7035 - Printed-circuit board connector



2201780

<https://www.phoenixcontact.com/us/products/2201780>

Classifications

ECLASS

ECLASS-11.0	27460202
ECLASS-12.0	27460202
ECLASS-13.0	27460202

ETIM

ETIM 9.0	EC002638
----------	----------

UNSPSC

UNSPSC 21.0	39121400
-------------	----------

HSCP-SP 2,5-1U4-7035 - Printed-circuit board connector



2201780

<https://www.phoenixcontact.com/us/products/2201780>

Environmental product compliance

China RoHS	Environmentally friendly use period: unlimited = EFUP-e
	No hazardous substances above threshold values

Phoenix Contact 2024 © - all rights reserved
<https://www.phoenixcontact.com>

Phoenix Contact USA
586 Fulling Mill Road
Middletown, PA 17057, United States
(+717) 944-1300
info@phoenixcon.com