

EH 52,5-B/ABS GY7035 - Mounting base housing



2201741

<https://www.phoenixcontact.com/us/products/2201741>

Please be informed that the data shown in this PDF document is generated from our online catalog. Please find the complete data in the user documentation. Our general terms of use for downloads are valid.



DIN rail housing, Lower housing part with base latch, tall design, with vents, width: 52.6 mm, height: 75 mm, depth: 87.3 mm, color: light grey (similar RAL 7035)

Your advantages

- DIN rail or wall mounting for application-specific device attachment
- Easy design-in, thanks to variable housing form factor
- Complete flexibility, thanks to PCBs with horizontal, frontal, and orthogonal orientation to the front of the device
- Three cover versions for individual PCB connections
- Integration of a wide variety of PCB connection technologies for a functional device design

Commercial data

Item number	2201741
Packing unit	10 pc
Minimum order quantity	10 pc
Sales key	AC12
Product key	ACHCHA
GTIN	4046356908177
Weight per piece (including packing)	60.1 g
Weight per piece (excluding packing)	60.1 g
Customs tariff number	84879090
Country of origin	IN

EH 52,5-B/ABS GY7035 - Mounting base housing

2201741

<https://www.phoenixcontact.com/us/products/2201741>

Technical data

Notes

General	Refer to the data sheet for the range in the download area.
---------	---

Product properties

Type	Lower housing parts with vents, housing cover necessary to complete the module
Product type	Enclosure bottom part
Housing series	EH
Product family	EH 52,5-..
Type	Lower housing part with base latch, tall design
Housing type	DIN rail housing
Ventilation openings present	yes

Dimensions

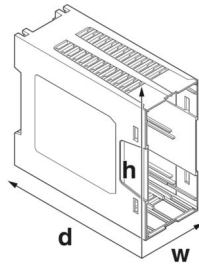
Dimensional drawing	
Width	52.6 mm
Height	75 mm
Depth	87.3 mm
Depth from top edge of DIN rail to support point on upper part	83 mm

PCB design

PCB thickness	1.4 mm ... 1.8 mm
---------------	-------------------

Material specifications

Color (Housing)	light grey (RAL 7035)
Flammability rating according to UL 94	HB
Surface characteristics	untreated
Housing material	ABS

Environmental and real-life conditions

Vibration test

Specification	IEC 60068-2-6:2007-12
Frequency	10 - 150 - 10 Hz
Sweep speed	1 octave/min
Amplitude	0.15 mm (10 Hz ... 58.1 Hz)

EH 52,5-B/ABS GY7035 - Mounting base housing



2201741

<https://www.phoenixcontact.com/us/products/2201741>

Acceleration	2g (58.1 Hz ... 150 Hz)
Test duration per axis	2.5 h
Test directions	X-, Y- and Z-axis

Glow-wire test

Specification	IEC 60695-2-11:2014-02
Temperature	850 °C
Time of exposure	30 s

Thermal stability / ball thrust test

Specification	IEC 60695-10-2:2014-02
Temperature	80 °C
Test duration	1 h
Force	20 N

Mechanical strength / tumbling barrel

Specification	IEC 60998-1:2002-12
Height of fall	50 cm
Frequency	10

Shocks

Specification	IEC 60068-2-27:2008-02
Pulse shape	Half-sine
Acceleration	15g
Shock duration	11 ms
Number of shocks per direction	3
Test directions	X-, Y- and Z-axis (pos. and neg.)

Degree of protection (IP code)

Specification	IEC 60529:1989-11 + AMD 1:1999-11 + AMD 2:2013-08
---------------	---

Ambient conditions

Max. IP code to attain	IP20
Ambient temperature (operation)	-40 °C ... 80 °C (depending on power dissipation)
Ambient temperature (storage/transport)	-40 °C ... 55 °C
Ambient temperature (assembly)	-5 °C ... 80 °C
Relative humidity (storage/transport)	95 %

PCB data

Number of PCB holders	5
Type of PCB mount	Latching
Thickness of the PCB	1.4 mm ... 1.8 mm

Mounting

Mounting type	DIN rail mounting/wall mounting (with optional base latch)
Mounting position	Vertical (horizontal DIN rail)

EH 52,5-B/ABS GY7035 - Mounting base housing



2201741

<https://www.phoenixcontact.com/us/products/2201741>

Packaging specifications

Type of packaging	packed in cardboard
Outer packaging type	Carton

EH 52,5-B/ABS GY7035 - Mounting base housing



2201741

<https://www.phoenixcontact.com/us/products/2201741>

Classifications

ECLASS

ECLASS-11.0	27182702
ECLASS-13.0	27190601

ETIM

ETIM 9.0	EC001031
----------	----------

UNSPSC

UNSPSC 21.0	31261500
-------------	----------

EH 52,5-B/ABS GY7035 - Mounting base housing



2201741

<https://www.phoenixcontact.com/us/products/2201741>

Environmental product compliance

China RoHS	Environmentally friendly use period: unlimited = EFUP-e
	No hazardous substances above threshold values

Phoenix Contact 2024 © - all rights reserved
<https://www.phoenixcontact.com>

Phoenix Contact USA
586 Fulling Mill Road
Middletown, PA 17057, United States
(+717) 944-1300
info@phoenixcon.com