

Modem - TC EXTENDER 4001 ETH-1S - 2702253

Please be informed that the data shown in this PDF Document is generated from our Online Catalog. Please find the complete data in the user's documentation. Our General Terms of Use for Downloads are valid (<http://phoenixcontact.com/download>)



Managed Ethernet extender, point-to-point connections, data rates up to 15.3 Mbps, distances of up to 20 km on in-house copper cables, replaceable surge protection, 1 SHDSL port, 1 LAN port, diagnostics via Ethernet

Your advantages

- ✓ Distances up to 20 km
- ✓ Up to 15.3 Mbps in 2-wire operation
- ✓ Robust modulation method (SHDSL)
- ✓ Automatic SHDSL data rate detection
- ✓ Network transparent (no IP configuration required)
- ✓ Automatic network data rate detection (10/100 Mbps)
- ✓ Easy startup, plug and play
- ✓ Alarm and signal output
- ✓ Remote diagnostics via IP and automatic event messages via SNMP



Key Commercial Data

Packing unit	1 pc
GTIN	 4 055626 055558
GTIN	4055626055558
Weight per Piece (excluding packing)	14,400.000 g
Custom tariff number	85176200
Country of origin	Germany

Technical data

Note

Modem - TC EXTENDER 4001 ETH-1S - 2702253

Technical data

Note

Utilization restriction	EMC: class A product, see manufacturer's declaration in the download area
	Use in potentially explosive areas is not permitted in China.

Dimensions

Width	60 mm
Height	130 mm
Depth	160 mm

Ambient conditions

Ambient temperature (operation)	-25 °C ... 60 °C
Ambient temperature (storage/transport)	-40 °C ... 85 °C
Permissible humidity (operation)	10 % ... 95 % (non-condensing)
Permissible humidity (storage/transport)	10 % ... 95 % (non-condensing)
Altitude	≤ 2500 m (For restrictions, see the manufacturer's declaration for altitude operation)
Degree of protection	IP20

General

Electrical isolation	VCC // Ethernet // DSL (A/B) // FE
Test voltage data interface/power supply	1.5 kV AC (50 Hz, 1 min.)
Electromagnetic compatibility	Conformance with EMC Directive 2014/30/EU
Mounting type	DIN rail: 35 mm
Net weight	258.7 g
Housing material	Aluminum / steel sheet DC01
MTTF	577 Years (SN 29500 standard, temperature 25°C, operating cycle 21%)
	300 Years (SN 29500 standard, temperature 40°C, operating cycle 34.25%)
	128 Years (SN 29500 standard, temperature 40°C, operating cycle 100%)

Power supply

Connection method	Push-in spring connection
Nominal supply voltage	24 V DC ±5 %
Supply voltage range	10 V DC ... 60 V DC
Typical current consumption	80 mA (60 V DC)
	200 mA (24 V DC)
	380 mA (10 V DC)
Connection method	Push-in spring connection

Interfaces

Interface 1	Ethernet interface, 10/100Base-T(X) in accordance with IEEE 802.3
-------------	---

Modem - TC EXTENDER 4001 ETH-1S - 2702253

Technical data

Interfaces

Interface	Ethernet
No. of ports	1
Connection method	RJ45 jack, shielded
	1 port 10/100Base-T(X), auto negotiation
Transmission length	< 100 m (shielded twisted pair)
Protocols supported	IPv4, IPv6, TCP/IP, HTTP, HTTPS
Auxiliary protocols	ARP, DHCP (Client), PING, SNMP
Serial transmission speed	10/100 Mbps, auto negotiation
Interface 2	SHDSL interface according to ITU-T G.991.2.bis
No. of ports	1 (2-wire operation)
Connection method	Push-in spring connection
Transmission length	< 20 km (Depending on data rate and cable cross section)
Conductor cross section solid min.	0.2 mm ²
Conductor cross section solid max.	1.5 mm ²
Conductor cross section flexible min.	0.2 mm ²
Conductor cross section flexible max.	2.5 mm ²
Conductor cross section AWG min.	24
Conductor cross section AWG max.	16
Serial transmission speed	2-wire operation: 32 kbps ... 15.3 Mbps

Function

Web-based management	yes
Management	Web-based management: Diagnostics, log book, customized configuration
Status and diagnostic indicators	LEDs for warning, status, and device information

Digital outputs

Output name	Digital output
Number of outputs	1
Voltage output signal	depending on the operating voltage
Current output signal	≤ 500 mA (Short-circuit-proof)
Connection method	Push-in spring connection

Conformance/approvals

Designation	CE
Identification	CE-compliant
Designation	ATEX
Identification	# II 3 G Ex nA IIC T4 Gc X
Additional text	Please follow the special installation instructions in the documentation!
Designation	UL, USA/Canada

Modem - TC EXTENDER 4001 ETH-1S - 2702253

Technical data

Conformance/approvals

Identification	508 Listed
Designation	Corrosive gas test
Identification	ISA-S71.04-1985 G3 Harsh Group A

Standards and Regulations

Electromagnetic compatibility	Conformance with EMC Directive 2014/30/EU
Type of test	Vibration resistance in acc. with EN 60068-2-6/IEC 60068-2-6
Test result	5g, 10...150 Hz, 2.5 h, in XYZ direction
Type of test	Shock in acc. with EN 60068-2-27/IEC 60068-2-27
Test result	15g
Standards/regulations	EN 61000-4-2
Contact discharge	± 6 kV
Indirect discharge	± 6 kV
Standards/regulations	EN 61000-4-3
Frequency range	80 MHz ... 3 GHz
Standards/regulations	EN 61000-4-4
Comments	Criterion B
Standards/regulations	EN 61000-4-5
Signal	± 1 kV (asymmetrical, shielded Ethernet cable)
	± 4 kV (asymmetrical: line to ground, unshielded SHDSL cable)
	± 2 kV (symmetrical: line to line, unshielded SHDSL cable)
Standards/regulations	EN 55011
	EN 61000-4-6
Frequency range	0.15 MHz ... 80 MHz
Standards/regulations	EN 50121-4

Environmental Product Compliance

REACH SVHC	Lead 7439-92-1
	Dechlorane Plus
China RoHS	Environmentally Friendly Use Period = 50 years
	For details about hazardous substances go to tab "Downloads", Category "Manufacturer's declaration"

Drawings

Modem - TC EXTENDER 4001 ETH-1S - 2702253

Schematic diagram

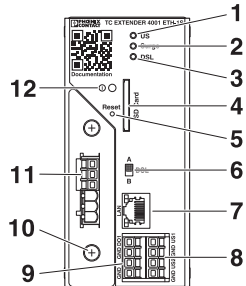

Front view

Schematic diagram

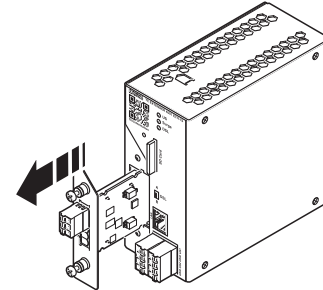

Replacement of protective module

Schematic diagram

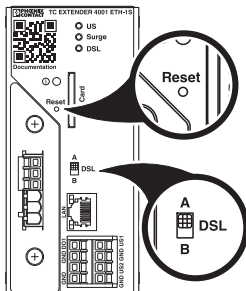

Reset button

Schematic diagram

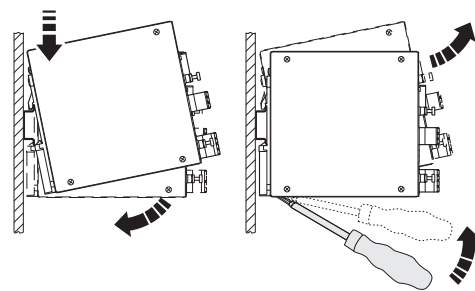

Mounting and removing

Schematic diagram

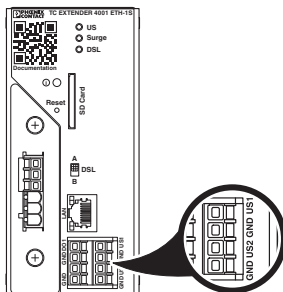

Power supply

Schematic diagram

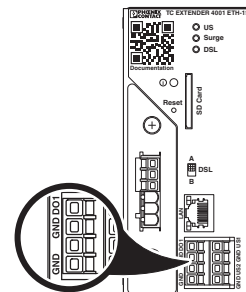

Digital switching output

Modem - TC EXTENDER 4001 ETH-1S - 2702253

Connection diagram

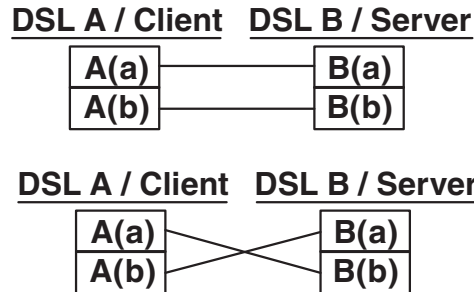

DSL connection

Circuit diagram

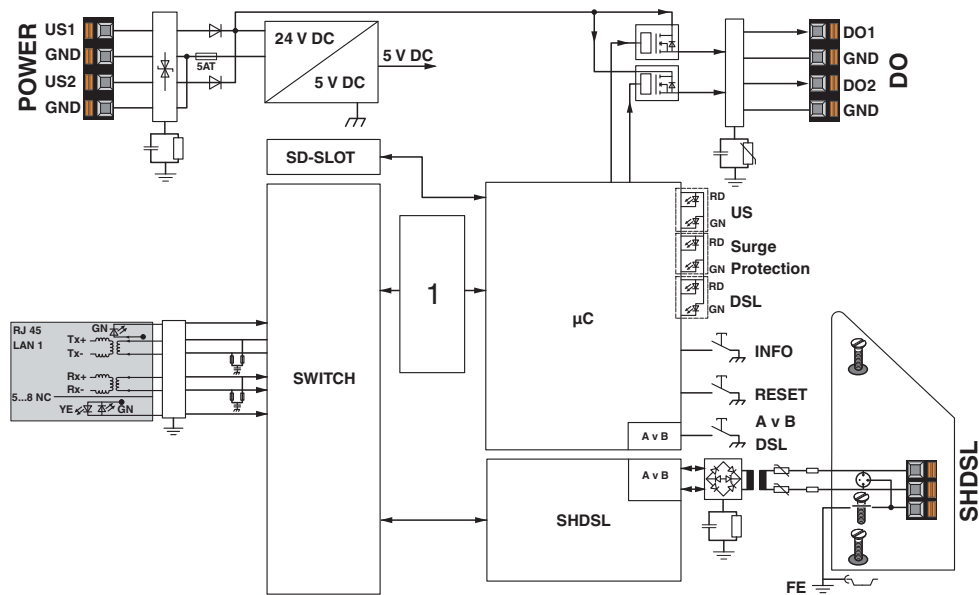

Classifications

eCl@ss

eCl@ss 10.0.1	19060590
eCl@ss 11.0	19060590
eCl@ss 5.0	19030100
eCl@ss 5.1	19030100
eCl@ss 6.0	19060500
eCl@ss 7.0	19060590
eCl@ss 9.0	19060590

Modem - TC EXTENDER 4001 ETH-1S - 2702253

Classifications

ETIM

ETIM 4.0	EC000740
ETIM 6.0	EC000740
ETIM 7.0	EC000740

UNSPSC

UNSPSC 6.01	30211506
UNSPSC 7.0901	39121008
UNSPSC 11	39121008
UNSPSC 12.01	39121008
UNSPSC 13.2	43222628
UNSPSC 18.0	43222628
UNSPSC 19.0	43222628
UNSPSC 20.0	43222628
UNSPSC 21.0	43222628

Approvals

Approvals

Approvals

UL Listed / cUL Listed / cULus Listed

Ex Approvals

ATEX

Approval details

UL Listed		http://database.ul.com/cgi-bin/XYV/template/LISEXT/1FRAME/index.htm	FILE E 238705
-----------	--	---	---------------

cUL Listed		http://database.ul.com/cgi-bin/XYV/template/LISEXT/1FRAME/index.htm	FILE E 238705
------------	--	---	---------------

Modem - TC EXTENDER 4001 ETH-1S - 2702253

Approvals

cULus Listed

