

D-SUB sleeve housings - CUC-DST-GZNI-A/DSFL15 - 1419757

Please be informed that the data shown in this PDF Document is generated from our Online Catalog. Please find the complete data in the user's documentation. Our General Terms of Use for Downloads are valid (<http://phoenixcontact.com/download>)

D-SUB sleeve housings, degree of protection: IP20, material: Zinc die-cast, cable outlet: angled, size of housing: 2, color: Bare metallic

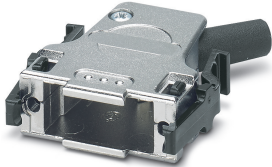

Your advantages

- ✓ Easy to mount thanks to catch spring system
- ✓ Angled conductor entry
- ✓ Well-suited for harsh industrial conditions thanks to its metal design
- ✓ Particularly suitable for D-SUB connectors with special contacts thanks to large interior



Key Commercial Data

Packing unit	1
GTIN	 4 055626 188164
GTIN	4055626188164
Custom tariff number	85389099

Technical data

Mechanical characteristics

Minimum external conductor diameter	3 mm
Maximum external conductor diameter	8.5 mm
Cable outlet	angled
No. of cable outlets	1
Weight	22.22 g
Flammability rating according to UL 94	V0

Ambient conditions

D-SUB sleeve housings - CUC-DST-GZNI-A/DSFL15 - 1419757

Technical data

Ambient conditions

Ambient temperature (operation)	-35 °C ... 100 °C
---------------------------------	-------------------

Material data

Housing material	Zinc die-cast
Housing surface material	Nickel-plated
Width	30.8 mm
Height	12.5 mm
Depth	17.2 mm
Mounting type	Fast locking system

Standards and Regulations

Flammability rating according to UL 94	V0
Safety note	WARNING: The connectors may not be plugged in or disconnected under load. Ignoring the warning or improper use may damage persons and/or property.
	<ul style="list-style-type: none"> • WARNING: Commission properly functioning products only. The products must be regularly inspected for damage. Decommission defective products immediately. Replace damaged products. Repairs are not possible.
	<ul style="list-style-type: none"> • WARNING: Only electrically qualified personnel may install and operate the product. They must observe the following safety notes. The qualified personnel must be familiar with the basics of electrical engineering. They must be able to recognize and prevent danger. The relevant symbol on the packaging indicates that only personnel familiar with electrical engineering are allowed to install and operate the product.
	<ul style="list-style-type: none"> • The products are suitable for applications in plant, controller, and electrical device engineering.
	<ul style="list-style-type: none"> • When operating the connectors in outdoor applications, they must be separately protected against environmental influences.
	<ul style="list-style-type: none"> • Assembled products may not be manipulated or improperly opened.
	<ul style="list-style-type: none"> • Only use mating connectors that are specified in the technical data of the standards listed (e.g. the ones listed in the product accessories online at phoenixcontact.com/products).
	<ul style="list-style-type: none"> • When using the product in direct connection with third-party manufacturers, the user is responsible.
	<ul style="list-style-type: none"> • For operating voltages > 50 V AC, conductive connector housings must be grounded
	<ul style="list-style-type: none"> • Only use tools recommended by Phoenix Contact
	<ul style="list-style-type: none"> • The installation notes/Design In documents online on the download page at phoenixcontact.com/products must be observed for this product.
	<ul style="list-style-type: none"> • Use a protective cap to protect connectors that are not in use. The suitable accessories are available online in the accessory section of the product at phoenixcontact.com/products
	<ul style="list-style-type: none"> • Operate the connector only when it is fully plugged in and interlocked.
	<ul style="list-style-type: none"> • Operate the connector only when it is fully plugged in.

D-SUB sleeve housings - CUC-DST-GZNI-A/DSFL15 - 1419757

Technical data

Standards and Regulations

	<ul style="list-style-type: none"> • Ensure that when laying the cable, the tensile load on the connectors does not exceed the upper limit specified in the standards.
	<ul style="list-style-type: none"> • Observe the minimum bending radius of the cable. Lay the cable without twisting it.
	<ul style="list-style-type: none"> • VDE 0100/1.97 § 411.1.3.2 and DIN EN 60 204/11.98 § 14.1.3 are applicable when combining several circuits in a cable and/or connector

Environmental Product Compliance

China RoHS	Environmentally friendly use period: unlimited = EFUP-e
	No hazardous substances above threshold values

Drawings

Dimensional drawing

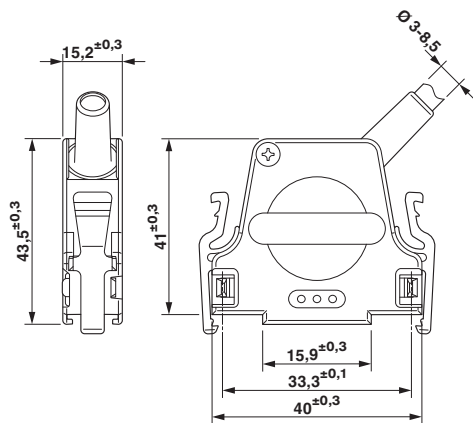

Schematic diagram

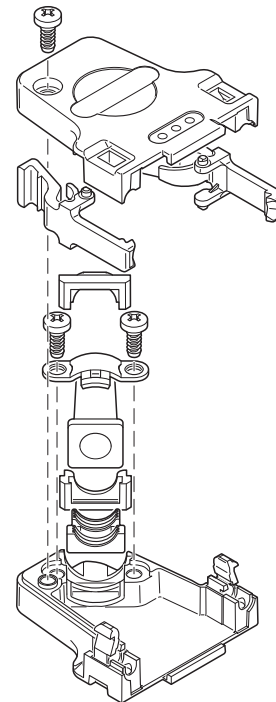

D-SUB sleeve housings

Classifications

eCl@ss

eCl@ss 10.0.1	27440302
eCl@ss 11.0	27440302
eCl@ss 4.0	27260700

D-SUB sleeve housings - CUC-DST-GZNI-A/DSFL15 - 1419757

Classifications

eCl@ss

eCl@ss 4.1	27260700
eCl@ss 5.0	27260700
eCl@ss 5.1	27261200
eCl@ss 6.0	27261200
eCl@ss 7.0	27440302
eCl@ss 9.0	27440302

ETIM

ETIM 2.0	EC000437
ETIM 3.0	EC000437
ETIM 4.0	EC000437
ETIM 6.0	EC001132
ETIM 7.0	EC001132

UNSPSC

UNSPSC 6.01	31261501
UNSPSC 7.0901	31261501
UNSPSC 11	31261501
UNSPSC 12.01	31261501
UNSPSC 13.2	39121522
UNSPSC 18.0	39121522
UNSPSC 19.0	39121522
UNSPSC 20.0	39121522
UNSPSC 21.0	39121522

Approvals

Approvals

Approvals

EAC

Ex Approvals

Approval details

D-SUB sleeve housings - CUC-DST-GZNI-A/DSFL15 - 1419757

Approvals

EAC



B.01742