

CUC-DST-GZNI-A/DSSC25 - D-SUB sleeve housings



1419728

<https://www.phoenixcontact.com/us/products/1419728>

Please be informed that the data shown in this PDF document is generated from our online catalog. Please find the complete data in the user documentation. Our general terms of use for downloads are valid.

D-SUB sleeve housings, degree of protection: IP20, material: Zinc die-cast, cable outlet: angled, housing size: 3, color: Bare metallic



Your advantages

- Easy to mount thanks to preassembled locking screws
- Angled conductor entry
- Antimagnetic plastic housing

Commercial data

Item number	1419728
Packing unit	1 pc
Minimum order quantity	1 pc
Sales key	AB11
Product key	ABNCAE
GTIN	4055626188065
Weight per piece (including packing)	71.5 g
Weight per piece (excluding packing)	71.5 g
Customs tariff number	85389099
Country of origin	DE

1419728

<https://www.phoenixcontact.com/us/products/1419728>

Technical data

Product properties

Type	D-SUB
Product type	Sleeve housings
No. of cable outlets	1
Cable outlet	angled

Connection data

Screw thread	4-40 UNC
--------------	----------

Dimensions

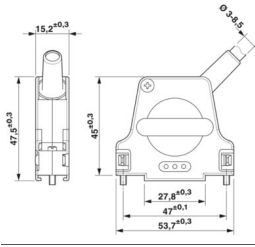
Dimensional drawing	
Width	53.7 mm
Height	15.2 mm
Depth	61.3 mm

Material specifications

Color	Bare metallic
Flammability rating according to UL 94	V0
Housing surface material	nickel-plated
Housing material	Zinc die-cast

Cable/line

External cable diameter ()	3 mm ... 8.5 mm (Without bending protection)
-----------------------------	--

Environmental and real-life conditions

Ambient conditions

Degree of protection	IP20
Ambient temperature (operation)	-35 °C ... 100 °C

Mounting

Mounting type	Screw locking mechanism
---------------	-------------------------

CUC-DST-GZNI-A/DSSC25 - D-SUB sleeve housings



1419728

<https://www.phoenixcontact.com/us/products/1419728>

Classifications

ECLASS

ECLASS-11.0	27440202
ECLASS-12.0	27440202
ECLASS-13.0	27440202

ETIM

ETIM 9.0	EC000437
----------	----------

UNSPSC

UNSPSC 21.0	31261500
-------------	----------

CUC-DST-GZNI-A/DSSC25 - D-SUB sleeve housings



1419728

<https://www.phoenixcontact.com/us/products/1419728>

Environmental product compliance

China RoHS	Environmentally friendly use period: unlimited = EFUP-e
	No hazardous substances above threshold values

Phoenix Contact 2024 © - all rights reserved
<https://www.phoenixcontact.com>

Phoenix Contact USA
586 Fulling Mill Road
Middletown, PA 17057, United States
(+717) 944-1300
info@phoenixcon.com