

PCB layout
view component side
thickness up to 3,2

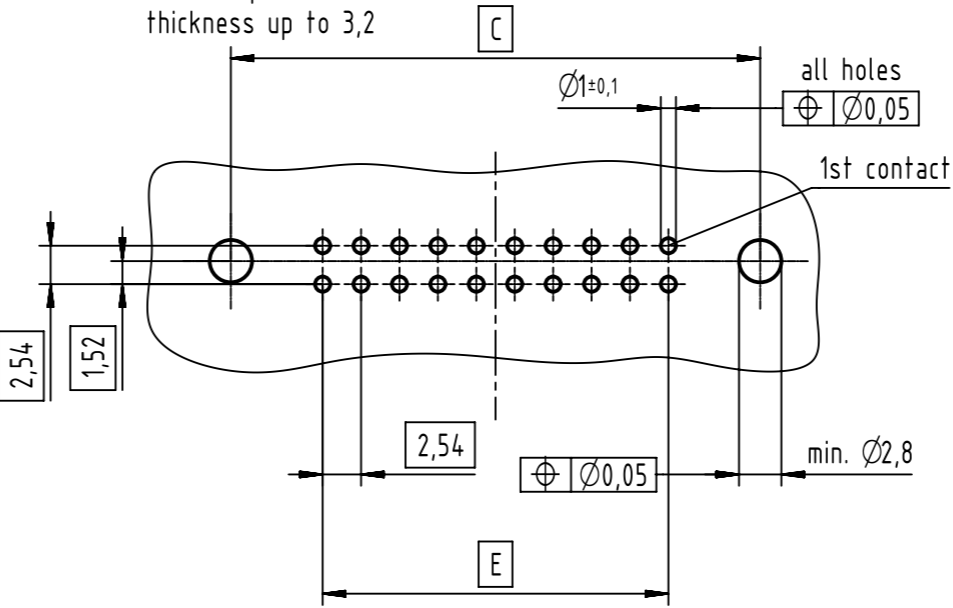
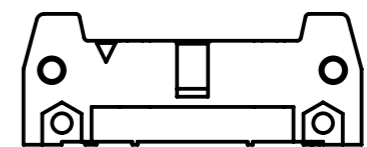
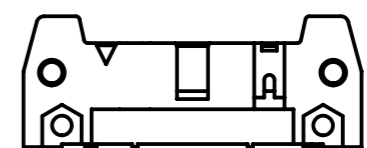
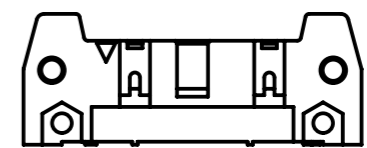

coding style table	
	style A: for connectors 6-pole
	style B: for connectors from 10 to 14-pole
	style C: for connectors from 16 to 64-pole

further information
see: DS 09181200001

full range of P/N's and
dimensions shown on page 2/2

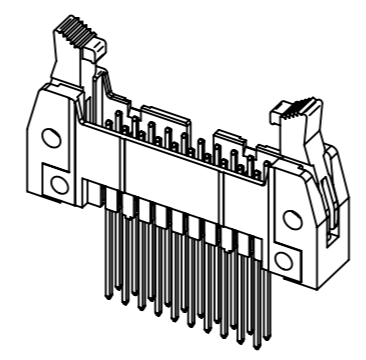

see table for coding,
feature arrangement and style

 All rights reserved Department EC PD - DE HARTING Electronics GmbH D-32339 Espelkamp	All Dimensions in mm Original Size DIN A3	Scale 2:1	Free size tol. IEC 60603-13	Ref. Sub. TB 09185XXX907 / 500000082999 / 2014-12-19
	Created by STORCK	Inspected by TADJE	Standardisation KOHLER	Date 2015-12-21
Title SEK 18 male standard conn str WW with long lever 15.0				Doc-Key / ECM-Nr. 100154464/UGD/047/A 50000094595
Type TB		Number 09185XXX907		Rev. A
				Page 1/2

no. of contacts	performance level			insulator colour	dimensions				
	PL3	PL2	S4		A max.	C	D	E	G
06	09 18 506 7907	09 18 506 6907	09 18 506 5907	grey	27,2	22,86	12,45	2,54 x 2 = 5,08	40,3
10	09 18 510 7907	09 18 510 6907	09 18 510 5907		32,3	27,94	17,53	2,54 x 4 = 10,16	45,4
14	09 18 514 7907	09 18 514 6907	09 18 514 5907		37,4	33,02	22,61	2,54 x 6 = 15,24	50,4
16	09 18 516 7907	09 18 516 6907	09 18 516 5907		39,9	35,56	25,15	2,54 x 7 = 17,78	53,0
20	09 18 520 7907	09 18 520 6907	09 18 520 5907		45,0	40,64	30,23	2,54 x 9 = 22,86	58,1
24	09 18 524 7907	09 18 524 6907	09 18 524 5907		50,1	45,72	35,91	2,54 x 11 = 27,94	63,2
26	09 18 526 7907	09 18 526 6907	09 18 526 5907		52,6	48,26	37,85	2,54 x 12 = 30,48	65,7
30	09 18 530 7907	09 18 530 6907	09 18 530 5907		58,0	53,34	43,83	2,54 x 14 = 35,56	68,6
34	09 18 534 7907	09 18 534 6907	09 18 534 5907		62,8	58,42	48,01	2,54 x 16 = 40,64	75,8
40	09 18 540 7907	09 18 540 6907	09 18 540 5907		70,4	66,04	55,63	2,54 x 19 = 48,26	83,5
50	09 18 550 7907	09 18 550 6907	09 18 550 5907		83,1	78,74	68,33	2,54 x 24 = 60,96	96,2
60	09 18 560 7907	09 18 560 6907	09 18 560 5907		95,8	91,44	81,03	2,54 x 29 = 73,66	108,9
64	09 18 564 7907	09 18 564 6907	09 18 564 5907		100,9	96,52	86,11	2,54 x 31 = 78,74	113,9

	All Dimensions in mm Original Size DIN A3	Scale 1:1	Free size tol.	Ref. Sub. TB 09185XXX907 / 500000082999 / 2014-12-19	
	All rights reserved Department EC PD - DE	Created by STORCK	Inspected by TADJE	Standardisation KOHLER	Date 2015-12-21
HARTING Electronics GmbH D-32339 Espelkamp		Title SEK 18 male standard conn str WW with long lever 15.0			Doc-Key / ECM-Nr. 100154464/UGD/047/A 500000094595
		Type TB	Number 09185XXX907		Rev. A Page 2/2