



Digital output block module XI/ON, 24 V DC, 16DO, 0.5A, pulse-switching



Powering Business Worldwide™

Part no. XN-16DO-24VDC-0.5A-P
Article no. 140141

Delivery program

Function			XI/ON I/O modules
Function			XN Block module
Short Description			16 Digital output, 24 V DC/0.5 A Positive switching
For use with			XN-B3T-SBC XN-B3S-SBC

Technical data



General

Standards			EN 61000-6-2 EN 61000-6-4 EN 61131-2
Potential isolation			Yes, through optocoupler
Ambient temperature			
Ambient temperature, operation		°C	0 - +55
Storage, transport	θ	°C	-25 - +85
Relative humidity			
Relative humidity			5 - 95 % (indoor), Level RH-2, no condensation (for storage at 45°C)
Ambient conditions, mechanical			
Degree of Protection			IP20
Harmful gases		ppm	SO ₂ : 10 (rel. humidity < 75%, no condensation) H ₂ S: 1.0 (rel. humidity < 75 %,no condensation)
Vibration resistance, operating conditions			according to IEC/EN 60068-2-6
Mechanical shock resistance		g	according to IEC 60068-2-27
Continuous shock resistance (IEC/EN 60068-2-29)			According to IEC 60068-2-29
Drop and topple			According to IEC 60068-2-31, free fall according to IEC 60068-2-32
Electromagnetic compatibility (EMC)			
ESD	Air/contact discharge	kV	EN 61100-4-2
Electromagnetic fields	(0.08...1) / (1,4...2) / (2...2,7) GHz	V/m	EN 61100-4-2
Burst			EN 61100-4-4
Surge			EN 61100-4-5
Radiated RFI		V	EN 61100-4-6
Emitted interference (radiated, high frequency)	(30...230 MHz) / (230...1000 MHz)	dB	EN 55016-2-3
Voltage fluctuations/voltage dips			EN 61131-2
Type test			to EN 61131-2
Approvals			CE, cULus
Other technical data (sheet catalogue)			Technical Data



Analog input modules

Channels		Number	16
Rated voltage through supply terminal	U _L		24 V DC
Rated current consumption from supply terminal	I _L	mA	30
Rated current consumption from module bus	I _{MB}	mA	≦ 120
Connectable sensors			Resistive loads Inductive loads Lamp loads
Diagnostics			4
Diagnostics			Yes

Analog output modules

Channels		Number	16
Rated voltage through supply terminal	U_L		24 V DC
Rated current consumption from supply terminal	I_L	mA	30
Rated current consumption from module bus	I_{MB}	mA	 120
Load resistance			
Resistive load		Ω	 48
Inductive load		h	1.2

Digital outputs

Channels		Number	16
Rated voltage through supply terminal	U_L		24 V DC
Rated current consumption from the supply terminal (at load current = 0 mA)	I_L	mA	30
Rated current consumption from module bus	I_{MB}	mA	 120
Power loss	P	W	Normally 4
Output voltage			
High level	U_H/U_A		$> U_L - 1$ V DC
Output current		A	
High level (rated value)	I_H		0.5 A
High level (permissible range)	I_H	A	< 0.6
Module total current		A	8
Delay on signal change and resistive load			
from Low to High level		μs	100
From High to Low signal		μs	100
Load resistance range			$> 48 \Omega$
Utilization factor	%	g	100
Can be connected			Resistive loads Inductive loads Lamp loads
Resistive load		Ω	 48
Inductive load		h	1.2
Lamp load	R_{LL}	W	 3
Switching frequency			
With resistive load	f	Hz	100 ($R_{L0} < 1$ k Ω)
Number of diagnostic bytes			4
Diagnostics			Yes
Outputs to EN 61131-2			short-circuit proof
Reset after short-circuit rectified	I_i		Automatic
Base modules			
with C connection			2-wire/3-wire XN-B3x-SBC

Digital inputs

Channels		Number	16
Rated voltage through supply terminal	U_L		24 V DC
Rated current consumption from supply terminal	I_L	mA	30
Rated current consumption from module bus	I_{MB}	mA	 120
Input voltage			
High level	U_{oH}	V	min. L+ (1 V)
Base modules			
with C connection			2-wire/3-wire XN-B3x-SBC

Relay modules

Rated voltage through supply terminal	U_L		24 V DC
Rated current consumption from supply terminal	I_L	mA	30
Rated current consumption from module bus	I_{MB}	mA	 120

Power loss	P	W	Normally 4
Can be connected			Resistive loads Inductive loads Lamp loads
Utilization factor	g	%	100
Base modules			
with C connection			2-wire/3-wire XN-B3x-SBC

Power supply module

Rated voltage through supply terminal	U_L		24 V DC
Rated current consumption from supply terminal	I_L	mA	30
Rated current consumption from module bus	I_{MB}	mA	 120
Diagnostics			4
Power loss	P	W	4

Counter module

Channels		Number	16
Rated voltage through supply terminal	U_L		24 V DC
Rated current consumption from supply terminal	I_L	mA	30
Rated current consumption from module bus	I_{MB}	mA	 120

Digital inputs

Input voltage			
High level	U_{eH}	V	min. L+ (1 V)

Digital outputs

Output current		A	
High level (permissible range)	I_H	A	< 0.6
High level (rated value)	I_H		0.5 A
Switching frequency			
with resistive load		Hz	100
Lamp load	R_{LL}	W	 3
Short-circuit rating			short-circuit proof

Measuring modes

Diagnostics			4
-------------	--	--	---

Interfaces

Rated voltage through supply terminal	U_L		24 V DC
Rated current consumption from supply terminal	I_L	mA	30
Rated current consumption from module bus	I_{MB}	mA	 120
Power loss	P	W	Normally 4
Number of diagnostic bytes			4

Notes

The supply terminal (U_L) provides power for the module electronics and for the consumers at the outputs. The total current required for each module consists of the sum of all partial currents.

Part of the XI/ON module's electronics is supplied with module bus voltage (5 V DC), the other part through the supply terminal (U_L).

To increase the maximum output current to up to 1 A, two outputs can be connected in parallel.

Note for table header

The rated current from supply terminal data apply at zero load current.

Applies for resistive load: $R_{LO} < 1k\Omega$

Design verification as per IEC/EN 61439

Technical data for design verification			
Rated operational current for specified heat dissipation	I_n	A	0
Heat dissipation per pole, current-dependent	P_{vid}	W	0
Equipment heat dissipation, current-dependent	P_{vid}	W	0
Static heat dissipation, non-current-dependent	P_{vs}	W	4
Heat dissipation capacity	P_{diss}	W	0
Operating ambient temperature min.		°C	0

Operating ambient temperature max.	°C	55
Degree of Protection		IP20
IEC/EN 61439 design verification		
10.2 Strength of materials and parts		
10.2.2 Corrosion resistance		Meets the product standard's requirements.
10.2.3.1 Verification of thermal stability of enclosures		Meets the product standard's requirements.
10.2.3.2 Verification of resistance of insulating materials to normal heat		Meets the product standard's requirements.
10.2.3.3 Verification of resistance of insulating materials to abnormal heat and fire due to internal electric effects		Meets the product standard's requirements.
10.2.4 Resistance to ultra-violet (UV) radiation		Meets the product standard's requirements.
10.2.5 Lifting		Does not apply, since the entire switchgear needs to be evaluated.
10.2.6 Mechanical impact		Does not apply, since the entire switchgear needs to be evaluated.
10.2.7 Inscriptions		Meets the product standard's requirements.
10.3 Degree of protection of ASSEMBLIES		Meets the product standard's requirements.
10.4 Clearances and creepage distances		Meets the product standard's requirements.
10.5 Protection against electric shock		Does not apply, since the entire switchgear needs to be evaluated.
10.6 Incorporation of switching devices and components		Does not apply, since the entire switchgear needs to be evaluated.
10.7 Internal electrical circuits and connections		Is the panel builder's responsibility.
10.8 Connections for external conductors		Is the panel builder's responsibility.
10.9 Insulation properties		
10.9.2 Power-frequency electric strength		Is the panel builder's responsibility.
10.9.3 Impulse withstand voltage		Is the panel builder's responsibility.
10.9.4 Testing of enclosures made of insulating material		Is the panel builder's responsibility.
10.10 Temperature rise		The panel builder is responsible for the temperature rise calculation. Eaton will provide heat dissipation data for the devices.
10.11 Short-circuit rating		Is the panel builder's responsibility.
10.12 Electromagnetic compatibility		Is the panel builder's responsibility.
10.13 Mechanical function		The device meets the requirements, provided the information in the instruction leaflet (IL) is observed.

Technical data ETIM 6.0

PLC's (EG000024) / Fieldbus, decentr. periphery - digital I/O module (EC001599)		
Electric engineering, automation, process control engineering / Control / Field bus, decentralized peripheral / Field bus, decentralized peripheral - digital I/O module (ecl@ss8.1-27-24-26-04 [BAA055011])		
Supply voltage AC 50 Hz	V	0 - 0
Supply voltage AC 60 Hz	V	0 - 0
Supply voltage DC	V	18 - 30
Voltage type of supply voltage		DC
Number of digital inputs		0
Number of digital outputs		16
Digital inputs configurable		No
Digital outputs configurable		No
Input current at signal 1	mA	0
Permitted voltage at input	V	0 - 0
Type of voltage (input voltage)		DC
Type of digital output		-
Output current	A	0.5
Permitted voltage at output	V	0 - 29
Type of output voltage		DC
Short-circuit protection, outputs available		Yes
Number of HW-interfaces industrial Ethernet		0
Number of HW-interfaces PROFINET		0
Number of HW-interfaces RS-232		0
Number of HW-interfaces RS-422		0
Number of HW-interfaces RS-485		0
Number of HW-interfaces serial TTY		0
Number of HW-interfaces parallel		0

Number of HW-interfaces Wireless		0
Number of HW-interfaces other		1
With optical interface		No
Supporting protocol for TCP/IP		No
Supporting protocol for PROFIBUS		Yes
Supporting protocol for CAN		Yes
Supporting protocol for INTERBUS		No
Supporting protocol for ASI		No
Supporting protocol for KNX		No
Supporting protocol for MODBUS		No
Supporting protocol for Data-Highway		No
Supporting protocol for DeviceNet		Yes
Supporting protocol for SUCONET		No
Supporting protocol for LON		No
Supporting protocol for PROFINET IO		No
Supporting protocol for PROFINET CBA		No
Supporting protocol for SERCOS		No
Supporting protocol for Foundation Fieldbus		No
Supporting protocol for EtherNet/IP		No
Supporting protocol for AS-Interface Safety at Work		No
Supporting protocol for DeviceNet Safety		No
Supporting protocol for INTERBUS-Safety		No
Supporting protocol for PROFIsafe		No
Supporting protocol for SafetyBUS p		No
Supporting protocol for other bus systems		Yes
Radio standard Bluetooth		No
Radio standard WLAN 802.11		No
Radio standard GPRS		No
Radio standard GSM		No
Radio standard UMTS		No
IO link master		No
System accessory		Yes
Degree of protection (IP)		IP20
Type of electric connection		Plug-in connection
Time delay at signal exchange	ms	0 - 0.3
Fieldbus connection over separate bus coupler possible		Yes
Rail mounting possible		Yes
Wall mounting/direct mounting		No
Front build in possible		No
Rack-assembly possible		No
Suitable for safety functions		No
Category according to EN 954-1		
SIL according to IEC 61508		None
Performance level acc. to EN ISO 13849-1		None
Appendant operation agent (Ex ia)		No
Appendant operation agent (Ex ib)		No
Explosion safety category for gas		None
Explosion safety category for dust		None
Width	mm	100.8
Height	mm	74.1
Depth	mm	55.4

Approvals

Product Standards		UL 508; CSA-C22.2 No. 142; IEC/EN 6113-2; CE marking
UL File No.		E205091

UL Category Control No.		NRAQ, NRAQ7
CSA File No.		UL report applies to both US and Canada
CSA Class No.		2252-01, 2252-81
North America Certification		UL recognized, certified by UL for use in Canada
Specially designed for North America		No
Current Limiting Circuit-Breaker		No
Degree of Protection		IEC: IP20, UL/CSA Type: -

Dimensions

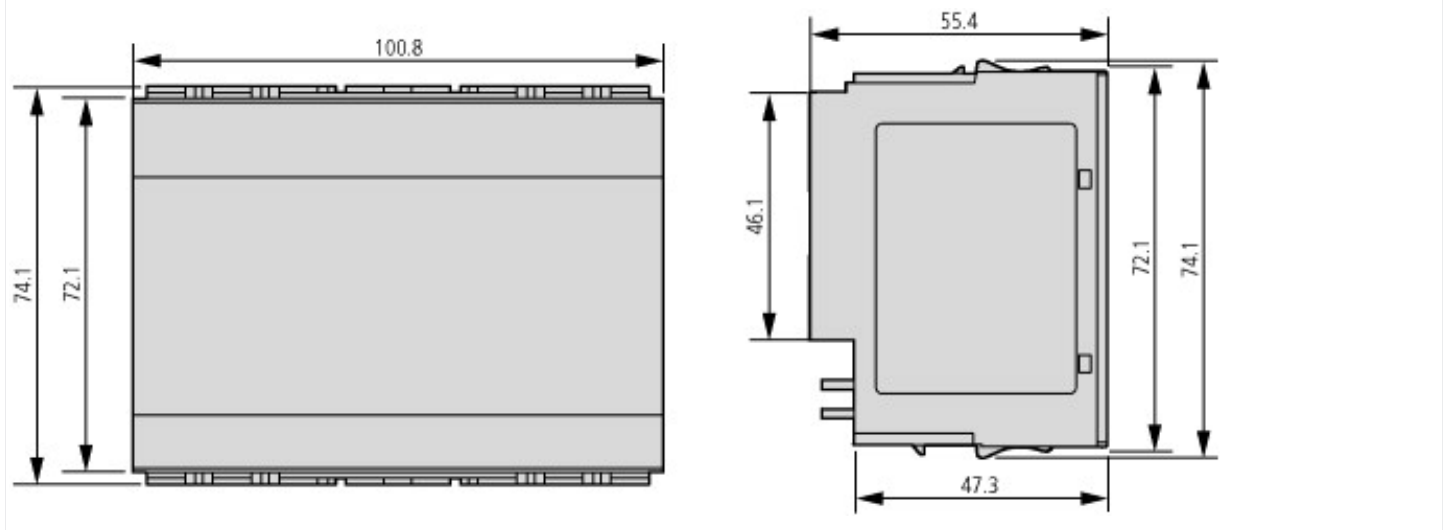

Dimensions

Additional product information (links)

MN05002010Z Manual Digital XI/ON modules, power supply modules

MN05002010Z Handbuch Digitale XI/ON-
Module Versorgungsmodule - Deutsch ftp://ftp.moeller.net/DOCUMENTATION/AWB_MANUALS/MN05002010Z_DE.pdf

MN05002010Z Manual Digital XI/ON modules,
power supply modules - English ftp://ftp.moeller.net/DOCUMENTATION/AWB_MANUALS/MN05002010Z_EN.pdf

Technical Data <http://ecat.moeller.net/flip-cat/?edition=HPLEN&startpage=14.111>