





**Main switch, 3 pole + N + 1 N/O + 1 N/C, 63 A, STOP function, 90 °,  
Lockable in the 0 (Off) position, surface mounting**

**Part no. T5B-3-8901/14/SVB-SW**  
**Article no. 207245**

## Delivery program

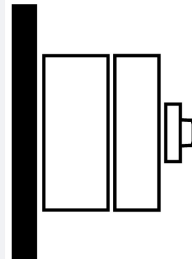
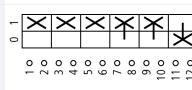
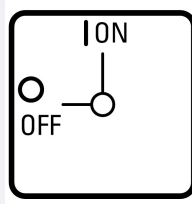
Product range			Main switch maintenance switch Repair switch
Part group reference			T5B
Stop Function			STOP function With black rotary handle and locking ring
Number of poles			3 pole + N
<b>Auxiliary contacts</b>			
		N/O	1
		N/C	1
Locking facility			Lockable in the 0 (Off) position
Degree of Protection			IP65
			<b>totally insulated</b>
Design			surface mounting 
Contact sequence			
Switching angle		°	90
Function			
<b>Motor rating AC-23A, 50 - 60 Hz</b>			
400 V	P	kW	30
Rated uninterrupted current	I <sub>u</sub>	A	63
Number of contact units		contact unit(s)	3

## Technical data

<b>General</b>			
Standards			IEC/EN 60947, VDE 0660, IEC/EN 60204, CSA, UL Switch-disconnector according to IEC/EN 60947-3
Climatic proofing			Damp heat, constant, to IEC 60068-2-78 Damp heat, cyclic, to IEC 60068-2-30
Ambient temperature			

Enclosed		°C	-25 - +40
Overtoltage category/pollution degree			III/3
Rated impulse withstand voltage	$U_{imp}$	V AC	6000
Mechanical shock resistance		g	15
Mounting position			As required
Protection against direct contact when actuated from front (EN 50274)			Finger and back-of-hand proof

## Contacts

Mechanical variables			
Number of poles			3 pole + N
Auxiliary contacts			
		N/O	1
		N/C	1
Electrical characteristics			
Rated operational voltage	$U_e$	V AC	690
Rated uninterrupted current	$I_u$	A	63
Note on rated uninterrupted current $I_u$			Rated uninterrupted current $I_u$ is specified for max. cross-section.
Load rating with intermittent operation, class 12			
AB 25 % DF		$x I_e$	2
AB 40 % DF		$x I_e$	1.6
AB 60 % DF		$x I_e$	1.3
Short-circuit rating			
Fuse		A gG/gL	80
Rated short-time withstand current (1 s current)	$I_{cw}$	$A_{rms}$	1300
Note on rated short-time withstand current $I_{cw}$			Current for a time of 1 second
Rated conditional short-circuit current	$I_q$	kA	2

## Switching capacity

$\cos \varphi$ rated making capacity as per IEC 60947-3		A	800
Rated breaking capacity $\cos \varphi$ to IEC 60947-3		A	
230 V		A	520
400/415 V		A	600
500 V		A	480
690 V		A	340
Safe isolation to EN 61140			
between the contacts		V AC	440
Current heat loss per contact at $I_e$		W	4.5
Current heat loss per auxiliary circuit at $I_e$ (AC-15/230 V)		CO	4.5
Lifespan, mechanical	Operations	$x 10^6$	> 0.5
Maximum operating frequency	Operations/h		1200
AC			
AC-3			
Rating, motor load switch	P	kW	
220 V 230 V	P	kW	15
230 V Star-delta	P	kW	18.5
400 V 415 V	P	kW	22
400 V Star-delta	P	kW	30
500 V	P	kW	22
500 V Star-delta	P	kW	37
690 V	P	kW	15
690 V Star-delta	P	kW	22
Rated operational current motor load switch			
230 V	$I_e$	A	51
230 V star-delta	$I_e$	A	63
400V 415 V	$I_e$	A	41
400 V star-delta	$I_e$	A	63

500 V	I <sub>e</sub>	A	33
500 V star-delta	I <sub>e</sub>	A	57.2
690 V	I <sub>e</sub>	A	17
690 V star-delta	I <sub>e</sub>	A	29.4
<b>AC-21A</b>			
Rated operational current switch			
440 V	I <sub>e</sub>	A	63
<b>AC-23A</b>			
Motor rating AC-23A, 50 - 60 Hz			
230 V	P	kW	18.5
400 V 415 V	P	kW	30
500 V	P	kW	22
690 V	P	kW	22
Rated operational current motor load switch			
230 V	I <sub>e</sub>	A	63
400 V 415 V	I <sub>e</sub>	A	63
500 V	I <sub>e</sub>	A	33
690 V	I <sub>e</sub>	A	23.8
<b>DC</b>			
DC-1, Load-break switches L/R = 1 ms			
Rated operational current	I <sub>e</sub>	A	63
Voltage per contact pair in series		V	60
DC-23A, motor load switch L/R = 15 ms			
24 V			
Rated operational current	I <sub>e</sub>	A	50
Contacts		Quantity	1
48 V			
Rated operational current	I <sub>e</sub>	A	50
Contacts		Quantity	2
60 V			
Rated operational current	I <sub>e</sub>	A	50
Contacts		Quantity	3
120 V			
Rated operational current	I <sub>e</sub>	A	25
Contacts		Quantity	3
240 V			
Rated operational current	I <sub>e</sub>	A	20
Contacts		Quantity	6
DC-13, Control switches L/R = 50 ms			
Rated operational current	I <sub>e</sub>	A	25
Voltage per contact pair in series		V	24
Control circuit reliability at 24 V DC, 10 mA	Fault probability	H <sub>F</sub>	< 10 <sup>-5</sup> , < 1 fault in 100000 operations

### Terminal capacities

Solid or stranded		mm <sup>2</sup>	1 x (2,5 - 35) 2 x (2,5 - 16)
Flexible with ferrules to DIN 46228		mm <sup>2</sup>	1 x (1 - 25) 2 x (1.5 - 10)
Terminal screw			M6
Max. tightening torque		Nm	4

### Technical safety parameters:

<b>Notes</b>			B10 <sub>d</sub> values as per EN ISO 13849-1, table C1
--------------	--	--	---

### Rating data for approved types

<b>Contacts</b>			
Rated operational voltage	U <sub>e</sub>	V AC	600
Rated uninterrupted current max.			

Main conducting paths			
General use	$I_U$	A	63
Switching capacity			
Maximum motor rating			
Single-phase			
120 V AC		HP	3
200 V AC		HP	7.5
240 V AC		HP	10
Three-phase			
200 V AC		HP	15
240 V AC		HP	15
480 V AC		HP	40
600 V AC		HP	40
Short Circuit Current Rating			
High fault rating		kA	10
max. Fuse		A	100, Class J
Terminal capacity			
Solid or flexible conductor with ferrule		AWG	12 - 4
Terminal screw			M6
Tightening torque		lb-in	35.4

## Design verification as per IEC/EN 61439

Technical data for design verification			
Rated operational current for specified heat dissipation	$I_n$	A	63
Heat dissipation per pole, current-dependent	$P_{vid}$	W	4.5
Equipment heat dissipation, current-dependent	$P_{vid}$	W	0
Static heat dissipation, non-current-dependent	$P_{vs}$	W	0
Heat dissipation capacity	$P_{diss}$	W	0
Operating ambient temperature min.		°C	-25
Operating ambient temperature max.		°C	40
IEC/EN 61439 design verification			
10.2 Strength of materials and parts			
10.2.2 Corrosion resistance			
			Meets the product standard's requirements.
10.2.3.1 Verification of thermal stability of enclosures			
			Meets the product standard's requirements.
10.2.3.2 Verification of resistance of insulating materials to normal heat			
			Meets the product standard's requirements.
10.2.3.3 Verification of resistance of insulating materials to abnormal heat and fire due to internal electric effects			
			Meets the product standard's requirements.
10.2.4 Resistance to ultra-violet (UV) radiation			
			Please enquire
10.2.5 Lifting			
			Does not apply, since the entire switchgear needs to be evaluated.
10.2.6 Mechanical impact			
			Does not apply, since the entire switchgear needs to be evaluated.
10.2.7 Inscriptions			
			Meets the product standard's requirements.
10.3 Degree of protection of ASSEMBLIES			
			Does not apply, since the entire switchgear needs to be evaluated.
10.4 Clearances and creepage distances			
			Meets the product standard's requirements.
10.5 Protection against electric shock			
			Does not apply, since the entire switchgear needs to be evaluated.
10.6 Incorporation of switching devices and components			
			Does not apply, since the entire switchgear needs to be evaluated.
10.7 Internal electrical circuits and connections			
			Is the panel builder's responsibility.
10.8 Connections for external conductors			
			Is the panel builder's responsibility.
10.9 Insulation properties			
10.9.2 Power-frequency electric strength			
			Is the panel builder's responsibility.
10.9.3 Impulse withstand voltage			
			Is the panel builder's responsibility.
10.9.4 Testing of enclosures made of insulating material			
			Is the panel builder's responsibility.
10.10 Temperature rise			
			The panel builder is responsible for the temperature rise calculation. Eaton will provide heat dissipation data for the devices.
10.11 Short-circuit rating			
			Is the panel builder's responsibility. The specifications for the switchgear must be observed.

10.12 Electromagnetic compatibility		Is the panel builder's responsibility. The specifications for the switchgear must be observed.
10.13 Mechanical function		The device meets the requirements, provided the information in the instruction leaflet (IL) is observed.

## Technical data ETIM 6.0

Low-voltage industrial components (EG000017) / Switch disconnecter (EC000216)		
Electric engineering, automation, process control engineering / Low-voltage switch technology / Off-load switch, circuit breaker, control switch / Switch disconnecter (ec@ss8.1-27-37-14-03 [AKF060010])		
Version as main switch		Yes
Version as maintenance-/service switch		Yes
Version as safety switch		No
Version as emergency stop installation		No
Version as reversing switch		No
Max. rated operation voltage Ue AC	V	690
Rated operating voltage	V	690 - 690
Rated permanent current Iu	A	63
Rated permanent current at AC-21, 400 V	A	63
Rated operation power at AC-3, 400 V	kW	22
Rated short-time withstand current Icw	kA	1.3
Rated operation power at AC-23, 400 V	kW	30
Switching power at 400 V	kW	30
Conditioned rated short-circuit current Iq	kA	2
Number of poles		4
Number of auxiliary contacts as normally closed contact		1
Number of auxiliary contacts as normally open contact		1
Number of auxiliary contacts as change-over contact		0
Motor drive optional		No
Motor drive integrated		No
Voltage release optional		No
Device construction		Complete device in housing
Suitable for ground mounting		Yes
Suitable for front mounting 4-hole		No
Suitable for front mounting center		No
Suitable for distribution board installation		No
Suitable for intermediate mounting		No
Colour control element		Black
Type of control element		Door coupling rotary drive
Interlockable		Yes
Type of electrical connection of main circuit		Screw connection
Degree of protection (IP), front side		IP65

## Approvals

Product Standards		UL 508; CSA-C22.2 No. 14-05; CSA-C22.2 No. 94; IEC/EN 60947-3; CE marking
UL File No.		E36332
UL Category Control No.		NLRV
CSA File No.		12528
CSA Class No.		3211-05
North America Certification		UL listed, CSA certified
Specially designed for North America		Yes, additional labeling according to UL on the enclosure in combination with "+NA-I4" (105868)
Suitable for		Branch circuits, suitable as motor disconnect
Degree of Protection		IEC: IP65; UL/CSA Type 1, 12

## Dimensions

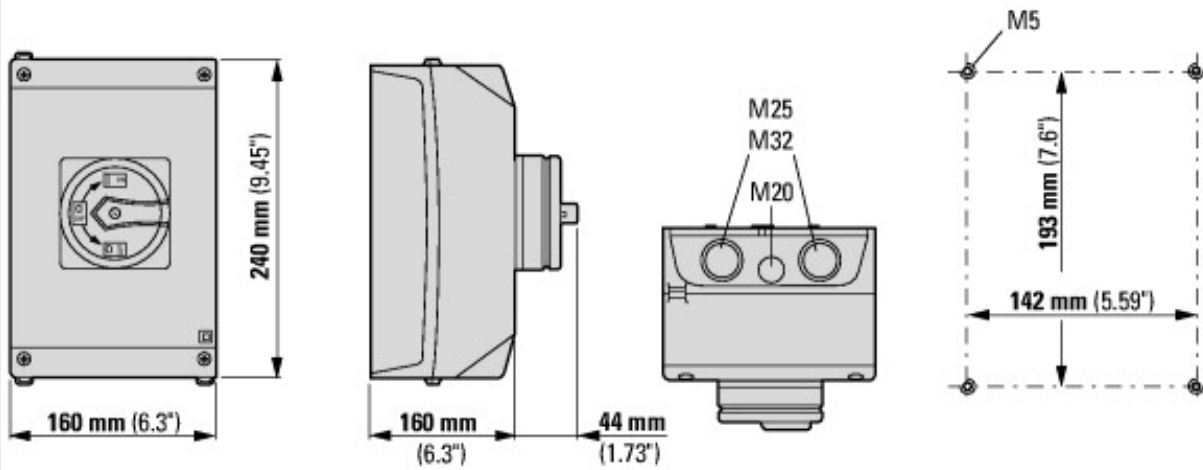

Cam switches T5B and T5 are of identical design, only their contacts are different



$$d = 4 - 8 \text{ mm}$$

$$b + d \leq 47 \text{ mm}$$

$$d = 0.16 - 0.31''$$

$$b + d \leq 1.85''$$

 3 padlocks

## Additional product information (links)

### IL03801009Z (AWA1150-1692) Cam switch: switch-disconnector

IL03801009Z (AWA1150-1692) Cam switch: switch-disconnector	<a href="ftp://ftp.moeller.net/DOCUMENTATION/AWA_INSTRUCTIONS/IL03801009Z2016_07.pdf">ftp://ftp.moeller.net/DOCUMENTATION/AWA_INSTRUCTIONS/IL03801009Z2016_07.pdf</a>
Form for ordering non-standard front plates	<a href="http://ecat.moeller.net/flip-cat/?edition=HPLEN&amp;startpage=4.87">http://ecat.moeller.net/flip-cat/?edition=HPLEN&amp;startpage=4.87</a>
Technical overview cam switch, switch-disconnector	<a href="http://de.ecat.moeller.net/flip-cat/?edition=HPLTEv1&amp;startpage=4.2">http://de.ecat.moeller.net/flip-cat/?edition=HPLTEv1&amp;startpage=4.2</a>
System overview cam switch T	<a href="http://de.ecat.moeller.net/flip-cat/?edition=HPLTEv1&amp;startpage=4.4">http://de.ecat.moeller.net/flip-cat/?edition=HPLTEv1&amp;startpage=4.4</a>
System overview switch-disconnector P	<a href="http://de.ecat.moeller.net/flip-cat/?edition=HPLTEv1&amp;startpage=4.6">http://de.ecat.moeller.net/flip-cat/?edition=HPLTEv1&amp;startpage=4.6</a>
Key to part numbers Cam switch	<a href="http://de.ecat.moeller.net/flip-cat/?edition=HPLTEv1&amp;startpage=4.8">http://de.ecat.moeller.net/flip-cat/?edition=HPLTEv1&amp;startpage=4.8</a>
Key to part numbers Switch-disconnector	<a href="http://de.ecat.moeller.net/flip-cat/?edition=HPLTEv1&amp;startpage=4.8">http://de.ecat.moeller.net/flip-cat/?edition=HPLTEv1&amp;startpage=4.8</a>
Switches for ATEX	<a href="http://www.coopercrouse-hinds.eu/en/products/25-ex-safety-and-main-current-switches.html">http://www.coopercrouse-hinds.eu/en/products/25-ex-safety-and-main-current-switches.html</a>