





Main switch, 6 pole + 1 N/O + 1 N/C, 32 A, Emergency-Stop function, 90 °, Lockable in the 0 (Off) position, flush mounting



Powering Business Worldwide™

Part no. T3-4-15682/EA/SVB
Article no. 054716

Delivery program

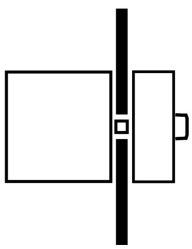
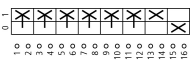
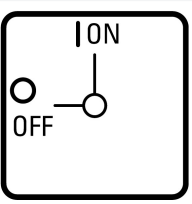
Product range			Main switch maintenance switch Repair switch
Part group reference			T3
Stop Function			Emergency switching off function With red rotary handle and yellow locking ring
Number of poles			6 pole
Auxiliary contacts			
		N/O	1
		N/C	1
Locking facility			Lockable in the 0 (Off) position
Degree of Protection			Front IP65
Design			flush mounting 
Contact sequence			
Switching angle		°	90
Function			
Motor rating AC-23A, 50 - 60 Hz			
400 V	P	kW	15
Rated uninterrupted current	I _u	A	32
Number of contact units		contact unit(s)	4

Technical data

General			
Standards			IEC/EN 60947, VDE 0660, IEC/EN 60204, CSA, UL Switch-disconnector according to IEC/EN 60947-3
Climatic proofing			Damp heat, constant, to IEC 60068-2-78 Damp heat, cyclic, to IEC 60068-2-30
Ambient temperature			
Open		°C	-25 - +50
Enclosed		°C	-25 - +40
Overvoltage category/pollution degree			III/3
Rated impulse withstand voltage	U _{imp}	V AC	6000

Mechanical shock resistance		g	15
Mounting position			As required
Protection against direct contact when actuated from front (EN 50274)			Finger and back-of-hand proof

Contacts

Mechanical variables			
Number of poles			6 pole
Auxiliary contacts			
		N/O	1
		N/C	1
Electrical characteristics			
Rated operational voltage	U_e	V AC	690
Rated uninterrupted current	I_u	A	32
Note on rated uninterrupted current I_u			Rated uninterrupted current I_u is specified for max. cross-section.
Load rating with intermittent operation, class 12			
AB 25 % DF		$x I_e$	2
AB 40 % DF		$x I_e$	1.6
AB 60 % DF		$x I_e$	1.3
Short-circuit rating			
Fuse		A gG/gL	35
Rated short-time withstand current (1 s current)	I_{cw}	A_{rms}	650
Note on rated short-time withstand current I_{cw}			Current for a time of 1 second
Rated conditional short-circuit current	I_q	kA	1

Switching capacity

cos ϕ rated making capacity as per IEC 60947-3		A	320
Rated breaking capacity cos ϕ to IEC 60947-3		A	
230 V		A	260
400/415 V		A	260
500 V		A	240
690 V		A	170
Safe isolation to EN 61140			
between the contacts		V AC	440
Current heat loss per contact at I_e		W	1.1
Current heat loss per auxiliary circuit at I_e (AC-15/230 V)		CO	1.1
Lifespan, mechanical	Operations	$x 10^6$	> 0.5
Maximum operating frequency	Operations/h		1200
AC			
AC-3			
Rating, motor load switch	P	kW	
220 V 230 V	P	kW	5.5
230 V Star-delta	P	kW	7.5
400 V 415 V	P	kW	11
400 V Star-delta	P	kW	15
500 V	P	kW	15
500 V Star-delta	P	kW	18.5
690 V	P	kW	11
690 V Star-delta	P	kW	22
Rated operational current motor load switch			
230 V	I_e	A	23.7
230 V star-delta	I_e	A	32
400V 415 V	I_e	A	23.7
400 V star-delta	I_e	A	32
500 V	I_e	A	23.7
500 V star-delta	I_e	A	32
690 V	I_e	A	14.7

690 V star-delta	I _e	A	25.5
AC-21A			
Rated operational current switch			
440 V	I _e	A	32
AC-23A			
Motor rating AC-23A, 50 - 60 Hz			
230 V	P	kW	7.5
400 V 415 V	P	kW	15
500 V	P	kW	15
690 V	P	kW	15
Rated operational current motor load switch			
230 V	I _e	A	32
400 V 415 V	I _e	A	32
500 V	I _e	A	26.4
690 V	I _e	A	17
DC			
DC-1, Load-break switches L/R = 1 ms			
Rated operational current	I _e	A	25
Voltage per contact pair in series		V	60
DC-21A			
Rated operational current	I _e	A	1
Contacts		Quantity	1
DC-23A, motor load switch L/R = 15 ms			
24 V			
Rated operational current	I _e	A	25
Contacts		Quantity	1
48 V			
Rated operational current	I _e	A	25
Contacts		Quantity	2
60 V			
Rated operational current	I _e	A	25
Contacts		Quantity	3
120 V			
Rated operational current	I _e	A	12
Contacts		Quantity	3
240 V			
Rated operational current	I _e	A	5
Contacts		Quantity	5
DC-13, Control switches L/R = 50 ms			
Rated operational current	I _e	A	20
Voltage per contact pair in series		V	24
Control circuit reliability at 24 V DC, 10 mA	Fault probability	H _F	< 10 ⁻⁵ , < 1 fault in 100000 operations

Terminal capacities

Solid or stranded		mm ²	1 x (1 - 6) 2 x (1 - 6)
Flexible with ferrules to DIN 46228		mm ²	1 x (0.75 - 4) 2 x (0.75 - 4)
Terminal screw			M4
Max. tightening torque		Nm	1.6

Technical safety parameters:

Notes			B10 _d values as per EN ISO 13849-1, table C1
--------------	--	--	---

Rating data for approved types

Contacts			
Rated operational voltage	U _e	V AC	600
Rated uninterrupted current max.			

Main conducting paths			
General use	I _U	A	25
Auxiliary contacts			
General Use	I _U	A	10
Pilot Duty			A 600 P 600
Switching capacity			
Maximum motor rating			
Single-phase			
120 V AC		HP	1.5
200 V AC		HP	3
240 V AC		HP	3
Three-phase			
200 V AC		HP	3
240 V AC		HP	3
480 V AC		HP	7.5
600 V AC		HP	10
Short Circuit Current Rating			
SCCR			
Basic Rating		kA	5
max. Fuse		A	40
High fault rating		kA	10
max. Fuse		A	40, Class J
Terminal capacity			
Solid or flexible conductor with ferrule		AWG	14 - 10
Terminal screw			M4
Tightening torque		lb-in	17.6

Design verification as per IEC/EN 61439

Technical data for design verification			
Rated operational current for specified heat dissipation	I _n	A	32
Heat dissipation per pole, current-dependent	P _{vid}	W	1.1
Equipment heat dissipation, current-dependent	P _{vid}	W	0
Static heat dissipation, non-current-dependent	P _{vs}	W	0
Heat dissipation capacity	P _{diss}	W	0
Operating ambient temperature min.		°C	-25
Operating ambient temperature max.		°C	50
IEC/EN 61439 design verification			
10.2 Strength of materials and parts			
10.2.2 Corrosion resistance			
			Meets the product standard's requirements.
10.2.3.1 Verification of thermal stability of enclosures			
			Meets the product standard's requirements.
10.2.3.2 Verification of resistance of insulating materials to normal heat			
			Meets the product standard's requirements.
10.2.3.3 Verification of resistance of insulating materials to abnormal heat and fire due to internal electric effects			
			Meets the product standard's requirements.
10.2.4 Resistance to ultra-violet (UV) radiation			
			Please enquire
10.2.5 Lifting			
			Does not apply, since the entire switchgear needs to be evaluated.
10.2.6 Mechanical impact			
			Does not apply, since the entire switchgear needs to be evaluated.
10.2.7 Inscriptions			
			Meets the product standard's requirements.
10.3 Degree of protection of ASSEMBLIES			
			Does not apply, since the entire switchgear needs to be evaluated.
10.4 Clearances and creepage distances			
			Meets the product standard's requirements.
10.5 Protection against electric shock			
			Does not apply, since the entire switchgear needs to be evaluated.
10.6 Incorporation of switching devices and components			
			Does not apply, since the entire switchgear needs to be evaluated.
10.7 Internal electrical circuits and connections			
			Is the panel builder's responsibility.
10.8 Connections for external conductors			
			Is the panel builder's responsibility.
10.9 Insulation properties			
10.9.2 Power-frequency electric strength			
			Is the panel builder's responsibility.

10.9.3 Impulse withstand voltage		Is the panel builder's responsibility.
10.9.4 Testing of enclosures made of insulating material		Is the panel builder's responsibility.
10.10 Temperature rise		The panel builder is responsible for the temperature rise calculation. Eaton will provide heat dissipation data for the devices.
10.11 Short-circuit rating		Is the panel builder's responsibility. The specifications for the switchgear must be observed.
10.12 Electromagnetic compatibility		Is the panel builder's responsibility. The specifications for the switchgear must be observed.
10.13 Mechanical function		The device meets the requirements, provided the information in the instruction leaflet (IL) is observed.

Technical data ETIM 6.0

Low-voltage industrial components (EG000017) / Switch disconnecter (EC000216)		
Electric engineering, automation, process control engineering / Low-voltage switch technology / Off-load switch, circuit breaker, control switch / Switch disconnecter (ecl@ss8.1-27-37-14-03 [AKF060010])		
Version as main switch		Yes
Version as maintenance-/service switch		Yes
Version as safety switch		No
Version as emergency stop installation		Yes
Version as reversing switch		No
Max. rated operation voltage Ue AC	V	690
Rated operating voltage	V	690 - 690
Rated permanent current Iu	A	32
Rated permanent current at AC-21, 400 V	A	32
Rated operation power at AC-3, 400 V	kW	11
Rated short-time withstand current Icw	kA	0.65
Rated operation power at AC-23, 400 V	kW	15
Switching power at 400 V	kW	15
Conditioned rated short-circuit current Iq	kA	1
Number of poles		6
Number of auxiliary contacts as normally closed contact		1
Number of auxiliary contacts as normally open contact		1
Number of auxiliary contacts as change-over contact		0
Motor drive optional		No
Motor drive integrated		No
Voltage release optional		No
Device construction		Built-in device fixed built-in technique
Suitable for ground mounting		No
Suitable for front mounting 4-hole		No
Suitable for front mounting center		Yes
Suitable for distribution board installation		No
Suitable for intermediate mounting		No
Colour control element		Red
Type of control element		Door coupling rotary drive
Interlockable		Yes
Type of electrical connection of main circuit		Screw connection
Degree of protection (IP), front side		IP65

Approvals

Product Standards		UL 508; CSA-C22.2 No. 14-05; CSA-C22.2 No. 94; IEC/EN 60947-3; CE marking
UL File No.		E36332
UL Category Control No.		NLRV
CSA File No.		12528
CSA Class No.		3211-05
North America Certification		UL listed, CSA certified
Suitable for		Branch circuits, suitable as motor disconnect
Degree of Protection		IEC: IP65; UL/CSA Type 1, 12

Dimensions

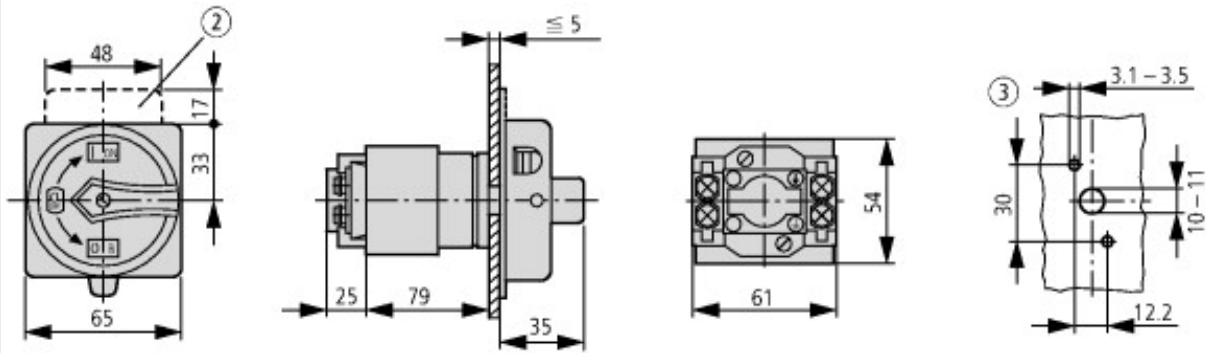

② ZFS... Label mount not included as standard

③ Drilling dimensions door

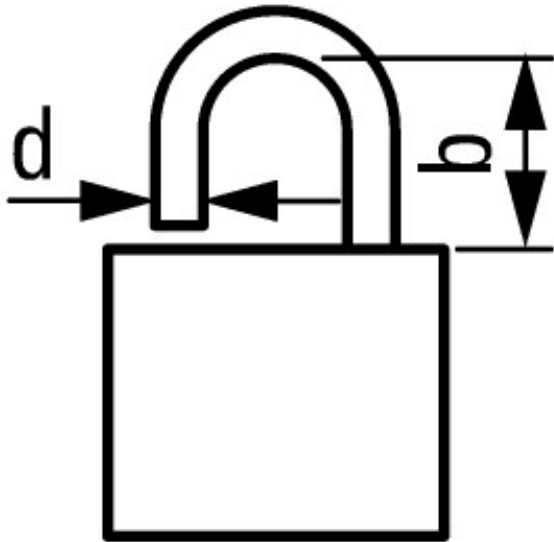

$d = 4 - 8 \text{ mm}$

$b + d \leq 47 \text{ mm}$

$d = 0.16 - 0.31''$

$b + d \leq 1.85''$

3 padlocks

Additional product information (links)

IL03801020Z (AWA1150-0586) Cam switch: Mounting

IL03801020Z (AWA1150-0586) Cam switch: Mounting	ftp://ftp.moeller.net/DOCUMENTATION/AWA_INSTRUCTIONS/IL03801020Z2016_07.pdf
Form for ordering non-standard front plates	http://ecat.moeller.net/flip-cat/?edition=HPLEN&startpage=4.87
Display flip catalog page.	http://ecat.moeller.net/flip-cat/?edition=K115A&startpage=41
Technical overview cam switch, switch-disconnector	http://de.ecat.moeller.net/flip-cat/?edition=HPLTEv1&startpage=4.2
System overview cam switch T	http://de.ecat.moeller.net/flip-cat/?edition=HPLTEv1&startpage=4.4
System overview switch-disconnector P	http://de.ecat.moeller.net/flip-cat/?edition=HPLTEv1&startpage=4.6
Key to part numbers Cam switch	http://de.ecat.moeller.net/flip-cat/?edition=HPLTEv1&startpage=4.8
Key to part numbers Switch-disconnector	http://de.ecat.moeller.net/flip-cat/?edition=HPLTEv1&startpage=4.8
Switches for ATEX	http://www.coopercrouse-hinds.eu/en/products/25-ex-safety-and-main-current-switches.html