





**On-Off switch, 3 pole + 1 N/O, 20 A, 90 °, surface mounting**

**Part no. T0-2-15679/11**  
**Article no. 207094**

## Delivery program

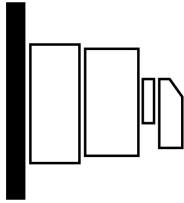
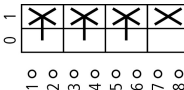
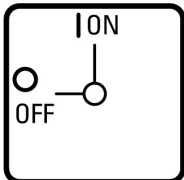
Product range			On-Off switch
Part group reference			T0 with black thumb grip and front plate
Number of poles			3 pole
<b>Auxiliary contacts</b>			
		N/O	1
		N/C	0
Degree of Protection			IP65
Design			<b>totally insulated</b> surface mounting 
Contact sequence			
Switching angle		°	90
Switching performance			maintained
Front plate no.			 <b>FS 908</b>
front plate			0-1
<b>Motor rating AC-23A, 50 - 60 Hz</b>			
400 V	P	kW	5.5
Rated uninterrupted current	I <sub>u</sub>	A	20
Number of contact units		contact unit(s)	2

## Technical data

<b>General</b>			
Standards			IEC/EN 60947, VDE 0660, IEC/EN 60204 Switch-disconnector according to IEC/EN 60947-3
Climatic proofing			Damp heat, constant, to IEC 60068-2-78 Damp heat, cyclic, to IEC 60068-2-30

Ambient temperature			
Enclosed		°C	-25 - +40
Overvoltage category/pollution degree			III/3
Rated impulse withstand voltage	$U_{imp}$	V AC	6000
Mechanical shock resistance		g	15
Mounting position			As required
Protection against direct contact when actuated from front (EN 50274)			Finger and back-of-hand proof

## Contacts

Mechanical variables			
Number of poles			3 pole
Auxiliary contacts			
		N/O	1
		N/C	0
Electrical characteristics			
Rated operational voltage	$U_e$	V AC	690
Rated uninterrupted current	$I_u$	A	20
Note on rated uninterrupted current $I_u$			Rated uninterrupted current $I_u$ is specified for max. cross-section.
Load rating with intermittent operation, class 12			
AB 25 % DF		$\times I_e$	2
AB 40 % DF		$\times I_e$	1.6
AB 60 % DF		$\times I_e$	1.3
Short-circuit rating			
Fuse		A gG/gL	20
Rated short-time withstand current (1 s current)	$I_{cw}$	$A_{rms}$	320
Note on rated short-time withstand current $I_{cw}$			Current for a time of 1 second
Rated conditional short-circuit current	$I_q$	kA	6

## Switching capacity

$\cos \varphi$ rated making capacity as per IEC 60947-3		A	130
Rated breaking capacity $\cos \varphi$ to IEC 60947-3		A	
230 V		A	100
400/415 V		A	110
500 V		A	80
690 V		A	60
Safe isolation to EN 61140			
between the contacts		V AC	440
Current heat loss per contact at $I_e$		W	0.6
Current heat loss per auxiliary circuit at $I_e$ (AC-15/230 V)		CO	0.6
Lifespan, mechanical	Operations	$\times 10^6$	> 0.4
Maximum operating frequency	Operations/h		1200
AC			
AC-3			
Rating, motor load switch	P	kW	
220 V 230 V	P	kW	3
230 V Star-delta	P	kW	5.5
400 V 415 V	P	kW	5.5
400 V Star-delta	P	kW	7.5
500 V	P	kW	5.5
500 V Star-delta	P	kW	7.5
690 V	P	kW	4
690 V Star-delta	P	kW	5.5
Rated operational current motor load switch			
230 V	$I_e$	A	11.5
230 V star-delta	$I_e$	A	20
400V 415 V	$I_e$	A	11.5

400 V star-delta	I <sub>e</sub>	A	20
500 V	I <sub>e</sub>	A	9
500 V star-delta	I <sub>e</sub>	A	15.6
690 V	I <sub>e</sub>	A	4.9
690 V star-delta	I <sub>e</sub>	A	8.5
<b>AC-21A</b>			
Rated operational current switch			
440 V	I <sub>e</sub>	A	20
<b>AC-23A</b>			
Motor rating AC-23A, 50 - 60 Hz			
230 V	P	kW	3
400 V 415 V	P	kW	5.5
500 V	P	kW	7.5
690 V	P	kW	5.5
Rated operational current motor load switch			
230 V	I <sub>e</sub>	A	13.3
400 V 415 V	I <sub>e</sub>	A	13.3
500 V	I <sub>e</sub>	A	13.3
690 V	I <sub>e</sub>	A	7.6
<b>DC</b>			
<b>DC-1, Load-break switches L/R = 1 ms</b>			
Rated operational current			
	I <sub>e</sub>	A	10
Voltage per contact pair in series			
		V	60
<b>DC-21A</b>			
Rated operational current			
	I <sub>e</sub>	A	1
Contacts			
		Quantity	1
<b>DC-23A, motor load switch L/R = 15 ms</b>			
24 V			
Rated operational current			
	I <sub>e</sub>	A	10
Contacts			
		Quantity	1
48 V			
Rated operational current			
	I <sub>e</sub>	A	10
Contacts			
		Quantity	2
60 V			
Rated operational current			
	I <sub>e</sub>	A	10
Contacts			
		Quantity	3
120 V			
Rated operational current			
	I <sub>e</sub>	A	5
Contacts			
		Quantity	3
240 V			
Rated operational current			
	I <sub>e</sub>	A	5
Contacts			
		Quantity	5
<b>DC-13, Control switches L/R = 50 ms</b>			
Rated operational current			
	I <sub>e</sub>	A	10
Voltage per contact pair in series			
		V	32
Control circuit reliability at 24 V DC, 10 mA			
	Fault probability	H <sub>F</sub>	< 10 <sup>-5</sup> , < 1 fault in 100000 operations

### Terminal capacities

Solid or stranded		mm <sup>2</sup>	1 x (1 - 2,5) 2 x (1 - 2,5)
Flexible with ferrules to DIN 46228		mm <sup>2</sup>	1 x (0.75 - 2.5) 2 x (0.75 - 2.5)
Terminal screw			M3.5
Max. tightening torque		Nm	1

## Technical safety parameters:

<b>Notes</b>			B10 <sub>q</sub> values as per EN ISO 13849-1, table C1
--------------	--	--	---------------------------------------------------------

## Rating data for approved types

Terminal capacity			
Terminal screw			M3.5
Tightening torque		lb-in	8.83

## Design verification as per IEC/EN 61439

Technical data for design verification			
Rated operational current for specified heat dissipation	I <sub>n</sub>	A	20
Heat dissipation per pole, current-dependent	P <sub>vid</sub>	W	0.6
Equipment heat dissipation, current-dependent	P <sub>vid</sub>	W	0
Static heat dissipation, non-current-dependent	P <sub>vs</sub>	W	0
Heat dissipation capacity	P <sub>diss</sub>	W	0
Operating ambient temperature min.		°C	-25
Operating ambient temperature max.		°C	40
IEC/EN 61439 design verification			
10.2 Strength of materials and parts			
10.2.2 Corrosion resistance			Meets the product standard's requirements.
10.2.3.1 Verification of thermal stability of enclosures			Meets the product standard's requirements.
10.2.3.2 Verification of resistance of insulating materials to normal heat			Meets the product standard's requirements.
10.2.3.3 Verification of resistance of insulating materials to abnormal heat and fire due to internal electric effects			Meets the product standard's requirements.
10.2.4 Resistance to ultra-violet (UV) radiation			Please enquire
10.2.5 Lifting			Does not apply, since the entire switchgear needs to be evaluated.
10.2.6 Mechanical impact			Does not apply, since the entire switchgear needs to be evaluated.
10.2.7 Inscriptions			Meets the product standard's requirements.
10.3 Degree of protection of ASSEMBLIES			Does not apply, since the entire switchgear needs to be evaluated.
10.4 Clearances and creepage distances			Meets the product standard's requirements.
10.5 Protection against electric shock			Does not apply, since the entire switchgear needs to be evaluated.
10.6 Incorporation of switching devices and components			Does not apply, since the entire switchgear needs to be evaluated.
10.7 Internal electrical circuits and connections			Is the panel builder's responsibility.
10.8 Connections for external conductors			Is the panel builder's responsibility.
10.9 Insulation properties			
10.9.2 Power-frequency electric strength			Is the panel builder's responsibility.
10.9.3 Impulse withstand voltage			Is the panel builder's responsibility.
10.9.4 Testing of enclosures made of insulating material			Is the panel builder's responsibility.
10.10 Temperature rise			The panel builder is responsible for the temperature rise calculation. Eaton will provide heat dissipation data for the devices.
10.11 Short-circuit rating			Is the panel builder's responsibility. The specifications for the switchgear must be observed.
10.12 Electromagnetic compatibility			Is the panel builder's responsibility. The specifications for the switchgear must be observed.
10.13 Mechanical function			The device meets the requirements, provided the information in the instruction leaflet (IL) is observed.

## Technical data ETIM 6.0

Low-voltage industrial components (EG000017) / Switch disconnecter (EC000216)			
Electric engineering, automation, process control engineering / Low-voltage switch technology / Off-load switch, circuit breaker, control switch / Switch disconnecter (ecl@ss8.1-27-37-14-03 [AKF060010])			
Version as main switch			No
Version as maintenance-/service switch			No
Version as safety switch			No
Version as emergency stop installation			No
Version as reversing switch			No
Max. rated operation voltage U <sub>e</sub> AC		V	690
Rated operating voltage		V	690 - 690
Rated permanent current I <sub>u</sub>		A	20

Rated permanent current at AC-21, 400 V	A	20
Rated operation power at AC-3, 400 V	kW	5.5
Rated short-time withstand current I <sub>cw</sub>	kA	0.32
Rated operation power at AC-23, 400 V	kW	5.5
Switching power at 400 V	kW	5.5
Conditioned rated short-circuit current I <sub>q</sub>	kA	6
Number of poles		3
Number of auxiliary contacts as normally closed contact		0
Number of auxiliary contacts as normally open contact		1
Number of auxiliary contacts as change-over contact		0
Motor drive optional		No
Motor drive integrated		No
Voltage release optional		No
Device construction		Complete device in housing
Suitable for ground mounting		Yes
Suitable for front mounting 4-hole		No
Suitable for front mounting center		No
Suitable for distribution board installation		No
Suitable for intermediate mounting		No
Colour control element		Black
Type of control element		Toggle
Interlockable		No
Type of electrical connection of main circuit		Screw connection
Degree of protection (IP), front side		IP65

## Dimensions

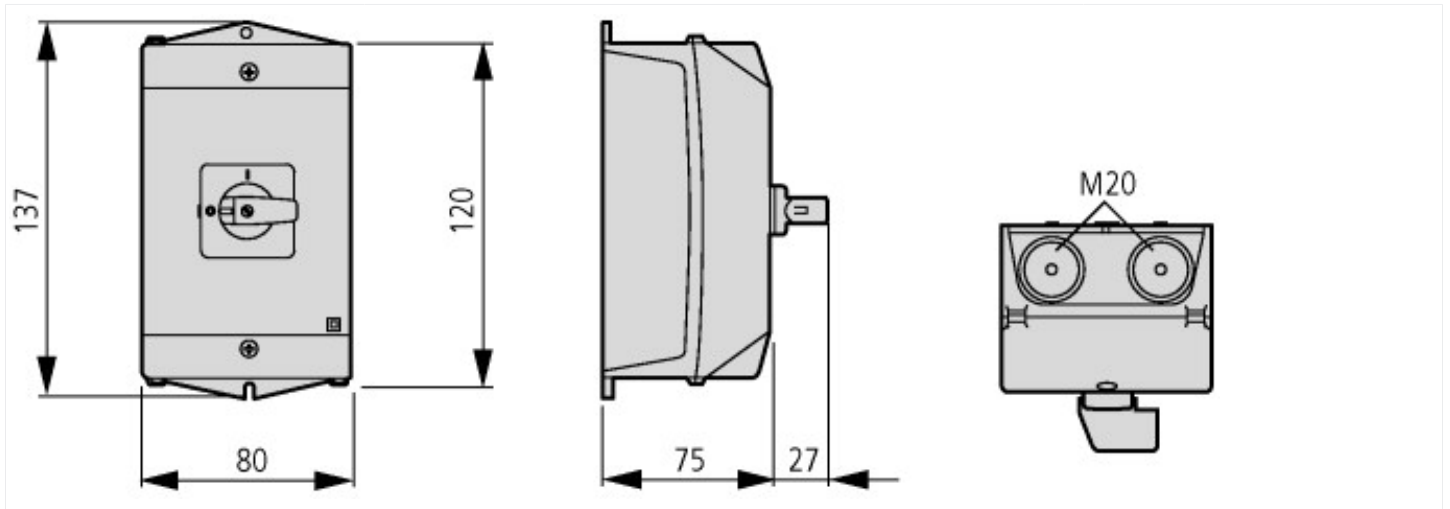

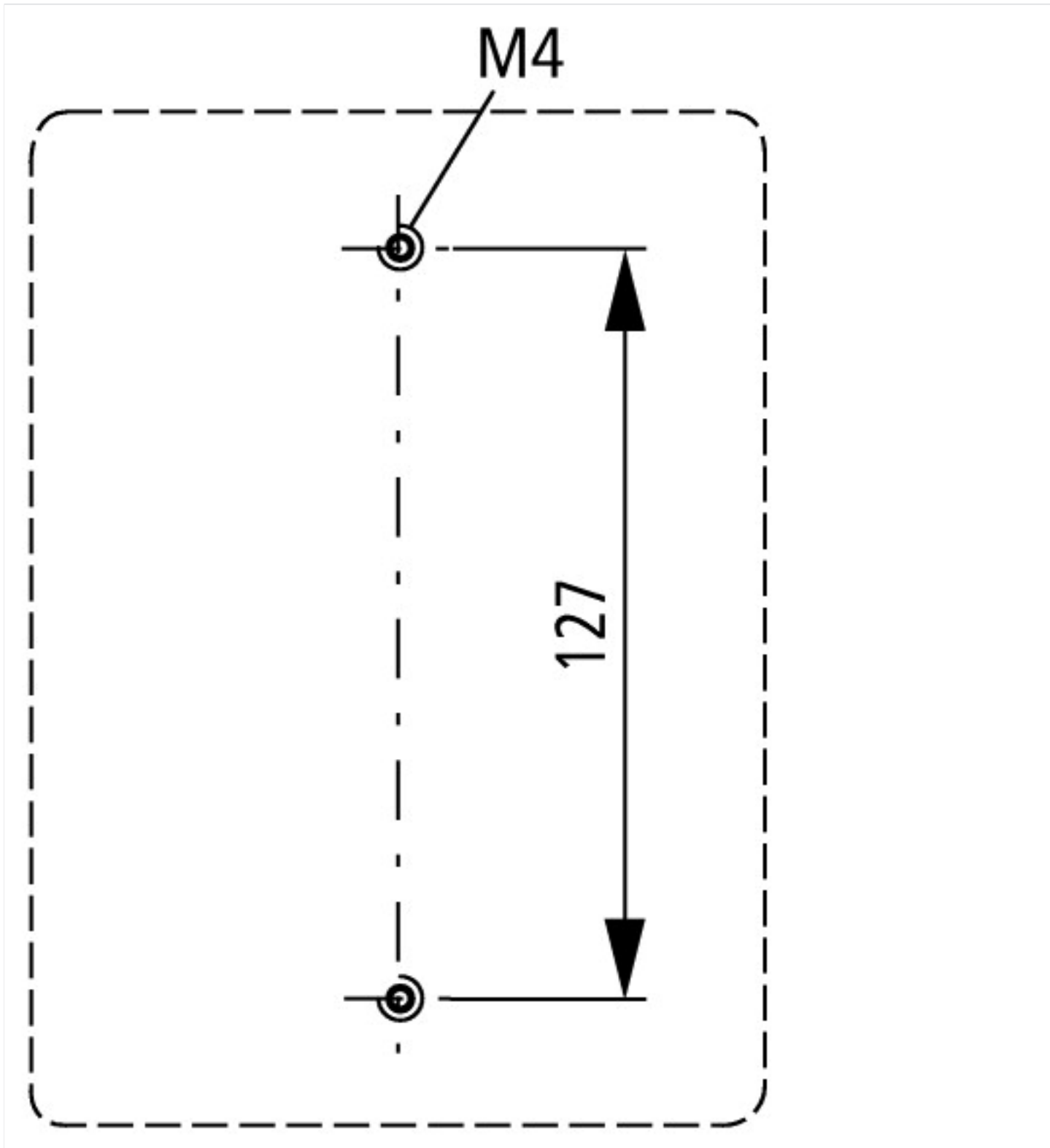

Drilling dimensions base

### Additional product information (links)

**IL03801007Z (AWA1150-1687) Cam switch: Surface mounting enclosure**

IL03801007Z (AWA1150-1687) Cam switch: Surface mounting enclosure	<a href="ftp://ftp.moeller.net/DOCUMENTATION/AWA_INSTRUCTIONS/IL03801007Z2016_07.pdf">ftp://ftp.moeller.net/DOCUMENTATION/AWA_INSTRUCTIONS/IL03801007Z2016_07.pdf</a>
Form for ordering non-standard front plates	<a href="http://ecat.moeller.net/flip-cat/?edition=HPLEN&amp;startpage=4.87">http://ecat.moeller.net/flip-cat/?edition=HPLEN&amp;startpage=4.87</a>
Display flip catalog page.	<a href="http://ecat.moeller.net/flip-cat/?edition=K115A&amp;startpage=40">http://ecat.moeller.net/flip-cat/?edition=K115A&amp;startpage=40</a>
Technical overview cam switch, switch-disconnector	<a href="http://de.ecat.moeller.net/flip-cat/?edition=HPLTEv1&amp;startpage=4.2">http://de.ecat.moeller.net/flip-cat/?edition=HPLTEv1&amp;startpage=4.2</a>
System overview cam switch T	<a href="http://de.ecat.moeller.net/flip-cat/?edition=HPLTEv1&amp;startpage=4.4">http://de.ecat.moeller.net/flip-cat/?edition=HPLTEv1&amp;startpage=4.4</a>
System overview switch-disconnector P	<a href="http://de.ecat.moeller.net/flip-cat/?edition=HPLTEv1&amp;startpage=4.6">http://de.ecat.moeller.net/flip-cat/?edition=HPLTEv1&amp;startpage=4.6</a>
Key to part numbers Cam switch	<a href="http://de.ecat.moeller.net/flip-cat/?edition=HPLTEv1&amp;startpage=4.8">http://de.ecat.moeller.net/flip-cat/?edition=HPLTEv1&amp;startpage=4.8</a>
Key to part numbers Switch-disconnector	<a href="http://de.ecat.moeller.net/flip-cat/?edition=HPLTEv1&amp;startpage=4.8">http://de.ecat.moeller.net/flip-cat/?edition=HPLTEv1&amp;startpage=4.8</a>
Switches for ATEX	<a href="http://www.coopercrouse-hinds.eu/en/products/25-ex-safety-and-main-current-switches.html">http://www.coopercrouse-hinds.eu/en/products/25-ex-safety-and-main-current-switches.html</a>

