

Fireman's switch, 30A, MC4, UA 230V50Hz

Part no. SOL30-SAFETY/2MC4-U(230V50HZ)
Article no. 144122
Catalog No. SOL30-SAFETY-2MC4-UF



Delivery program

Product range			Switchgear for photovoltaic systems
Subrange			Fireman's switch
Product range			Fireman's Switch
Application field			Residential buildings Utility buildings
Part no.			SOL-Safety
Rated operational voltage	U_e	V	1000
Inputs number of strings			2
Inputs connection type			MC4
Outputs number of strings			1
Outputs connection type			MC4

Technical data

General

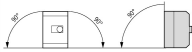
Standards			IEC/EN 60 947-3
Mounting position			
Mounting position			As required
Description			Application: DC isolation in photovoltaic systems between PV generator and power inverter for disconnecting power Remote tripping with integrated undervoltage release 230 V, 50 Hz Signalling of switch state via auxiliary contact 1 N/O and 1 NC Prewired ready for connection Lockable with padlock in OFF position Spring switch function

Electrical

Number of poles			2 pole
Rated operational voltage	U_e	V	1000
up to 440 V 50/60 Hz	I_{cm}	kA	0.3
Rated short-time withstand current (t=1s)	I_{cw}	kA	0.7
Utilization category			DC-21 A
Overvoltage category/pollution degree			III/3
Rated impulse withstand voltage	U_{imp}	kV	8
Electrical		Operation	4500
Internal resistance		mΩ	7

Mechanical

Weight		kg	0.47
Degree of Protection			IP65
Ambient temperature			
Open		°C	-25 - +60
Climatic proofing			Damp heat, constant, to IEC 60068-2-78 Damp heat, cyclic, to IEC 60068-2-30
Lifespan, mechanical	Operations		100000
Max. operating frequency		Ops/h	120

Design verification as per IEC/EN 61439

Technical data for design verification			
Operating ambient temperature min.		°C	-25
Operating ambient temperature max.		°C	60

Technical data ETIM 6.0

Low-voltage industrial components (EG000017) / Switch disconnecter (EC000216)		
Electric engineering, automation, process control engineering / Low-voltage switch technology / Off-load switch, circuit breaker, control switch / Switch disconnecter (ec@ss8.1-27-37-14-03 [AKF060010])		
Version as main switch		No
Version as maintenance-/service switch		Yes
Version as safety switch		No
Version as emergency stop installation		No
Version as reversing switch		No
Max. rated operation voltage Ue AC	V	0
Rated operating voltage	V	1000 - 1000
Rated permanent current Iu	A	32
Rated permanent current at AC-21, 400 V	A	0
Rated operation power at AC-3, 400 V	kW	0
Rated short-time withstand current Icw	kA	0.36
Rated operation power at AC-23, 400 V	kW	0
Switching power at 400 V	kW	30
Conditioned rated short-circuit current Iq	kA	0
Number of poles		2
Number of auxiliary contacts as normally closed contact		0
Number of auxiliary contacts as normally open contact		0
Number of auxiliary contacts as change-over contact		1
Motor drive optional		No
Motor drive integrated		No
Voltage release optional		Yes
Device construction		Complete device in housing
Suitable for ground mounting		Yes
Suitable for front mounting 4-hole		No
Suitable for front mounting center		No
Suitable for distribution board installation		No
Suitable for intermediate mounting		No
Colour control element		Black
Type of control element		Toggle
Interlockable		No
Type of electrical connection of main circuit		-
Degree of protection (IP), front side		IP65

Characteristics

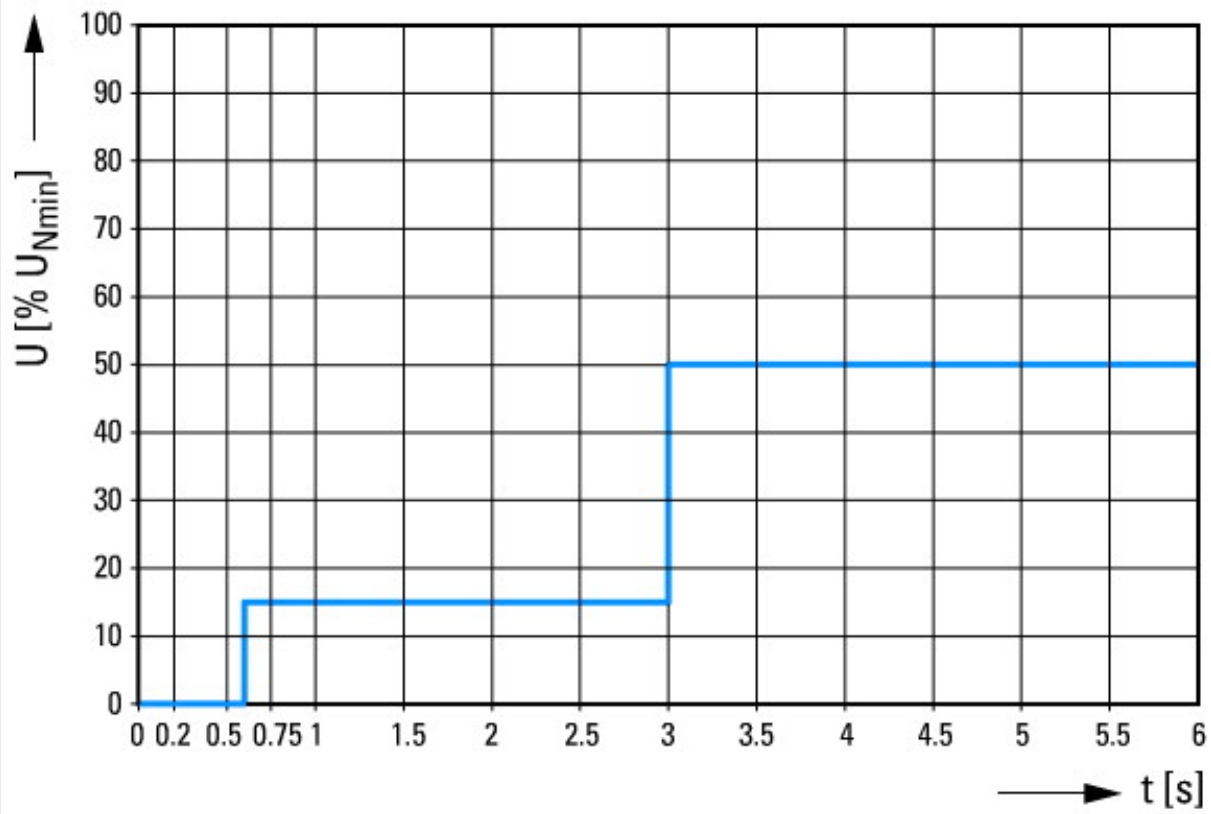

Limits for the delay times used to maintain operation in the event of voltage fluctuations.

Dimensions

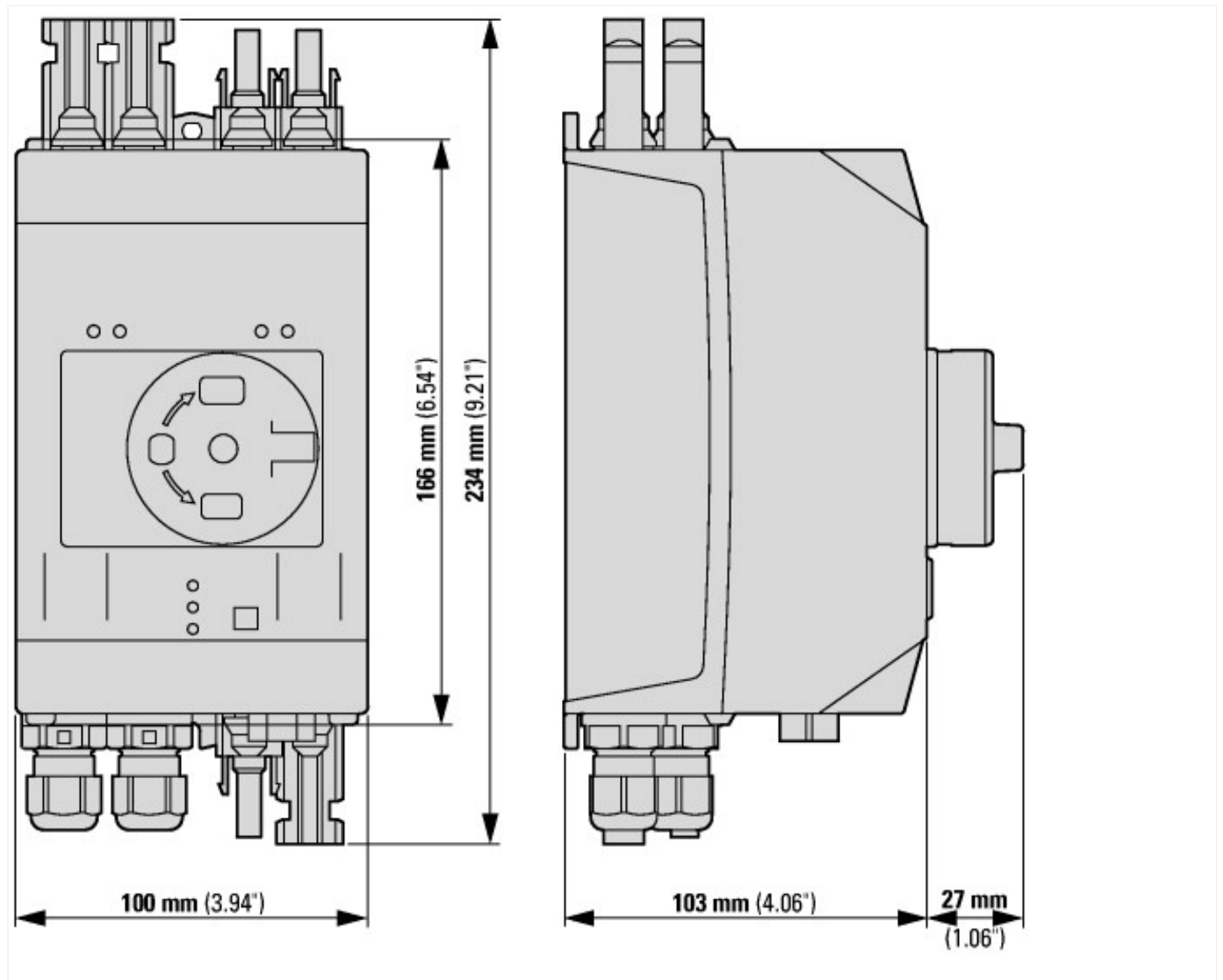

Additional product information (links)

Motor starters and "Special Purpose Ratings" for the North American market

http://www.moeller.net/binary/ver_techpapers/ver953en.pdf

Busbar Component Adapters for modern Industrial control panels

http://www.moeller.net/binary/ver_techpapers/ver960en.pdf