





Main switch, 3 pole + N, 315 A, Emergency-Stop function, Lockable in the 0 (Off) position, flush mounting

Part no. P5-315/EA/SVB/N
Article no. 280952

Delivery program

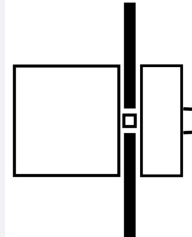
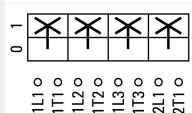
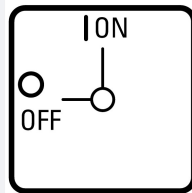
Product range			Main switch maintenance switch Repair switch
Part group reference			P5
Stop Function			Emergency switching off function With red rotary handle and yellow locking ring
Information about equipment supplied			auxiliary contact fitted by user.
Number of poles			3 pole + N
Auxiliary contacts			
		N/O	0
		N/C	0
Locking facility			Lockable in the 0 (Off) position
Degree of Protection			Front IP65
Design			flush mounting 
Contact sequence			
Function			
Motor rating AC-23A, 50 - 60 Hz			
400 V	P	kW	110
Rated uninterrupted current	I _u	A	315

Technical data

General			
Standards			IEC/EN 60947, VDE 0660, IEC/EN 60204, CSA, UL Switch-disconnector according to IEC/EN 60947-3
Climatic proofing			Damp heat, constant, to IEC 60068-2-78 Damp heat, cyclic, to IEC 60068-2-30
Ambient temperature			
Open		°C	-25 - +50
Enclosed		°C	-25 - +40
Overvoltage category/pollution degree			III/3
Rated impulse withstand voltage	U _{imp}	V AC	8000

Mounting position			As required
Protection against direct contact when actuated from front (EN 50274)			Finger and back-of-hand proof
Contacts			
Mechanical variables			
Number of poles			3 pole + N
Auxiliary contacts			
		N/O	0
		N/C	0
Electrical characteristics			
Rated operational voltage	U_e	V AC	690
Rated uninterrupted current	I_u	A	315
Note on rated uninterrupted current I_u			Rated uninterrupted current I_u is specified for max. cross-section.
Load rating with intermittent operation, class 12			
AB 25 % DF		$\times I_e$	2
AB 40 % DF		$\times I_e$	1.6
AB 60 % DF		$\times I_e$	1.3
Short-circuit rating			
Fuse		A gG/gL	315
Rated short-time withstand current (1 s current)	I_{cw}	A_{rms}	5800
Note on rated short-time withstand current I_{cw}			Current for a time of 1 second
Rated conditional short-circuit current	I_q	kA	15
Switching capacity			
$\cos \varphi$ rated making capacity as per IEC 60947-3		A	2050
Rated breaking capacity $\cos \varphi$ to IEC 60947-3		A	
230 V		A	1800
400/415 V		A	1650
500 V		A	1550
690 V		A	400
Safe isolation to EN 61140			
between the contacts		V AC	440
Current heat loss per contact at I_e		W	16
Lifespan, mechanical	Operations	$\times 10^6$	> 0.08
Maximum operating frequency	Operations/h		50
AC			
AC-3			
Rating, motor load switch	P	kW	
220 V 230 V	P	kW	45
400 V 415 V	P	kW	75
500 V	P	kW	90
690 V	P	kW	45
Rated operational current motor load switch			
230 V	I_e	A	147
400V 415 V	I_e	A	138
500 V	I_e	A	135
690 V	I_e	A	50
AC-21A			
Rated operational current switch			
440 V	I_e	A	315
AC-23A			
Motor rating AC-23A, 50 - 60 Hz	P	kW	
230 V	P	kW	55
400 V 415 V	P	kW	110
500 V	P	kW	132
690 V	P	kW	45

Rated operational current motor load switch			
230 V	I_e	A	182
400 V 415 V	I_e	A	205
500 V	I_e	A	184
690 V	I_e	A	50
DC			
DC-1, Load-break switches L/R = 1 ms			
Rated operational current	I_e	A	315
Voltage per contact pair in series		V	42
DC-23A, motor load switch L/R = 15 ms			
24 V			
Rated operational current	I_e	A	315
Contacts		Quantity	3
48 V			
Rated operational current	I_e	A	315
Contacts		Quantity	3
60 V			
Rated operational current	I_e	A	315
Contacts		Quantity	3
120 V			
Rated operational current	I_e	A	100
Contacts		Quantity	3
Control circuit reliability at 24 V DC, 10 mA	Fault probability	H_F	$< 10^{-5}$, < 1 fault in 100000 operations

Terminal capacities

Solid or stranded		mm ²	1 x (16 - 185) 2 x (16 - 70)
Flexible with ferrules to DIN 46228		mm ²	1 x (25 - 120) 2 x (25 - 50)
Copper strip	Number of segments x width x thickness	mm	6 x 20 x 1 (2 flat conductors)
Terminal screw			Allen screw 6
Max. tightening torque		Nm	16

Technical safety parameters:

Notes			B10 _d values as per EN ISO 13849-1, table C1
--------------	--	--	---------------------------------------------------------

Rating data for approved types

Contacts			
Rated operational voltage	U_e	V AC	600
Rated uninterrupted current max.			
Main conducting paths			
General use	I_U	A	300
Auxiliary contacts			
General Use	I_U	A	10
Pilot Duty			A 600
Switching capacity			
Maximum motor rating			
Single-phase			
120 V AC		HP	20
240 V AC		HP	35
277 V AC		HP	35
Three-phase			
120 V AC		HP	40
240 V AC		HP	75
480 V AC		HP	100
600 V AC		HP	100

Short Circuit Current Rating		SCCR	
Basic Rating		kA	10
max. Fuse		A	800, RK1
High fault rating		kA	65
max. Fuse		A	400, Class J
Terminal capacity			
Solid or flexible conductor with ferrule		AWG	350 MCM
Flexible		AWG	300 MCM
Terminal screw			Allen screw 6
Tightening torque		lb-in	140

Design verification as per IEC/EN 61439

Technical data for design verification			
Rated operational current for specified heat dissipation	I_n	A	315
Heat dissipation per pole, current-dependent	P_{vid}	W	16
Equipment heat dissipation, current-dependent	P_{vid}	W	0
Static heat dissipation, non-current-dependent	P_{vs}	W	0
Heat dissipation capacity	P_{diss}	W	0
Operating ambient temperature min.		°C	-25
Operating ambient temperature max.		°C	50
IEC/EN 61439 design verification			
10.2 Strength of materials and parts			
10.2.2 Corrosion resistance			
			Meets the product standard's requirements.
10.2.3.1 Verification of thermal stability of enclosures			
			Meets the product standard's requirements.
10.2.3.2 Verification of resistance of insulating materials to normal heat			
			Meets the product standard's requirements.
10.2.3.3 Verification of resistance of insulating materials to abnormal heat and fire due to internal electric effects			
			Meets the product standard's requirements.
10.2.4 Resistance to ultra-violet (UV) radiation			
			Please enquire
10.2.5 Lifting			
			Does not apply, since the entire switchgear needs to be evaluated.
10.2.6 Mechanical impact			
			Does not apply, since the entire switchgear needs to be evaluated.
10.2.7 Inscriptions			
			Meets the product standard's requirements.
10.3 Degree of protection of ASSEMBLIES			
			Does not apply, since the entire switchgear needs to be evaluated.
10.4 Clearances and creepage distances			
			Meets the product standard's requirements.
10.5 Protection against electric shock			
			Does not apply, since the entire switchgear needs to be evaluated.
10.6 Incorporation of switching devices and components			
			Does not apply, since the entire switchgear needs to be evaluated.
10.7 Internal electrical circuits and connections			
			Is the panel builder's responsibility.
10.8 Connections for external conductors			
			Is the panel builder's responsibility.
10.9 Insulation properties			
10.9.2 Power-frequency electric strength			
			Is the panel builder's responsibility.
10.9.3 Impulse withstand voltage			
			Is the panel builder's responsibility.
10.9.4 Testing of enclosures made of insulating material			
			Is the panel builder's responsibility.
10.10 Temperature rise			
			The panel builder is responsible for the temperature rise calculation. Eaton will provide heat dissipation data for the devices.
10.11 Short-circuit rating			
			Is the panel builder's responsibility. The specifications for the switchgear must be observed.
10.12 Electromagnetic compatibility			
			Is the panel builder's responsibility. The specifications for the switchgear must be observed.
10.13 Mechanical function			
			The device meets the requirements, provided the information in the instruction leaflet (IL) is observed.

Technical data ETIM 6.0

Low-voltage industrial components (EG000017) / Switch disconnector (EC000216)			
Electric engineering, automation, process control engineering / Low-voltage switch technology / Off-load switch, circuit breaker, control switch / Switch disconnector (ecl@ss8.1-27-37-14-03 [AKF060010])			
Version as main switch			Yes
Version as maintenance-/service switch			Yes
Version as safety switch			No

Version as emergency stop installation		Yes
Version as reversing switch		No
Max. rated operation voltage Ue AC	V	690
Rated operating voltage	V	690 - 690
Rated permanent current Iu	A	315
Rated permanent current at AC-21, 400 V	A	315
Rated operation power at AC-3, 400 V	kW	75
Rated short-time withstand current Icw	kA	5.8
Rated operation power at AC-23, 400 V	kW	110
Switching power at 400 V	kW	110
Conditioned rated short-circuit current Iq	kA	15
Number of poles		4
Number of auxiliary contacts as normally closed contact		0
Number of auxiliary contacts as normally open contact		0
Number of auxiliary contacts as change-over contact		0
Motor drive optional		No
Motor drive integrated		No
Voltage release optional		No
Device construction		Built-in device fixed built-in technique
Suitable for ground mounting		No
Suitable for front mounting 4-hole		Yes
Suitable for front mounting center		No
Suitable for distribution board installation		No
Suitable for intermediate mounting		No
Colour control element		Red
Type of control element		Door coupling rotary drive
Interlockable		Yes
Type of electrical connection of main circuit		Frame clamp
Degree of protection (IP), front side		IP65

Approvals

Product Standards		UL 508; CSA-C22.2 No. 14-05; CSA-C22.2 No. 94; IEC/EN 60947-3; CE marking
UL File No.		E36332
UL Category Control No.		NLRV, NLRV7
CSA File No.		223805
CSA Class No.		3211-05
North America Certification		UL listed, CSA certified
Suitable for		Branch circuits, suitable as motor disconnect
Degree of Protection		IEC: IP65; UL/CSA Type 1, 12

Dimensions

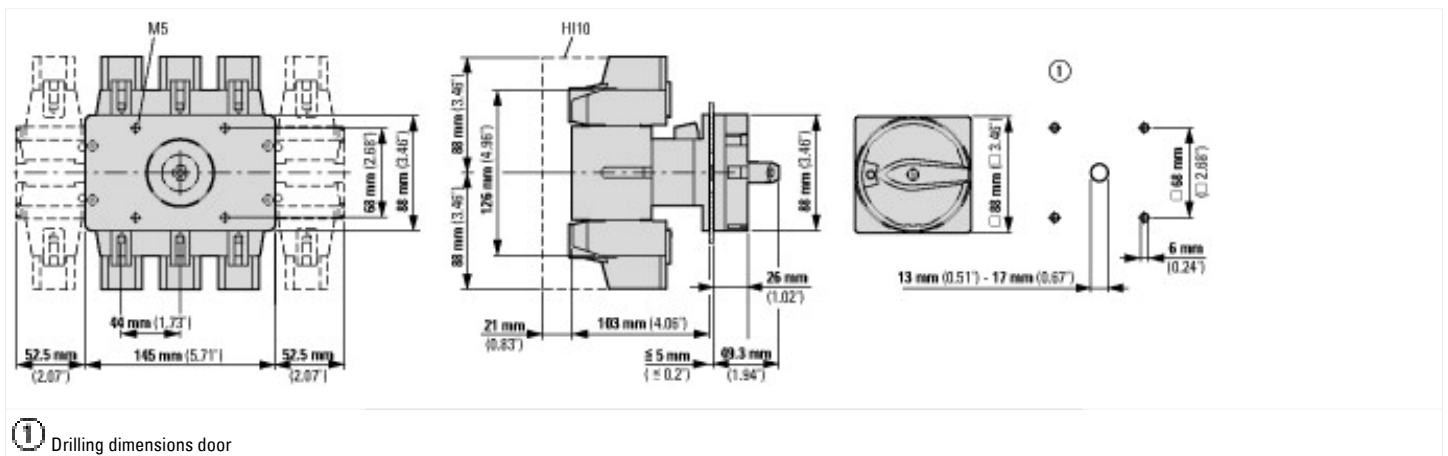



$$d = 4 - 8 \text{ mm}$$

$$b + d \leq 47 \text{ mm}$$

$$d = 0.16 - 0.31''$$

$$b + d \leq 1.85''$$

 3 padlocks

Additional product information (links)

IL03802010Z Cam Switch: Main switch, On-Off-switch

IL03802010Z Cam Switch: Main switch, On-Off-switch	ftp://ftp.moeller.net/DOCUMENTATION/AWA_INSTRUCTIONS/IL03802010Z2016_05.pdf
Technical overview cam switch, switch-disconnector	http://de.ecat.moeller.net/flip-cat/?edition=HPLTEv1&startpage=4.2
System overview cam switch T	http://de.ecat.moeller.net/flip-cat/?edition=HPLTEv1&startpage=4.4
System overview switch-disconnector P	http://de.ecat.moeller.net/flip-cat/?edition=HPLTEv1&startpage=4.6
Key to part numbers Cam switch	http://de.ecat.moeller.net/flip-cat/?edition=HPLTEv1&startpage=4.8
Key to part numbers Switch-disconnector	http://de.ecat.moeller.net/flip-cat/?edition=HPLTEv1&startpage=4.8
Switches for ATEX	http://www.coopercrouse-hinds.eu/en/products/25-ex-safety-and-main-current-switches.html