





**Main switch, 3 pole + N, 125 A, Emergency-Stop function, Lockable in the 0 (Off) position, rear mounting**



Powering Business Worldwide™

**Part no. P5-125/V/SVB/N**  
**Article no. 280916**

## Delivery program

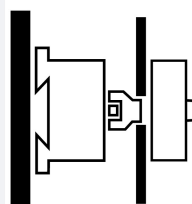
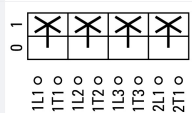
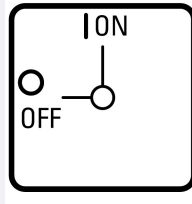
Product range				Main switch maintenance switch Repair switch
Part group reference				P5
Stop Function				Emergency switching off function With red rotary handle and yellow locking ring
Information about equipment supplied				auxiliary contact fitted by user.
Number of poles				3 pole + N
<b>Auxiliary contacts</b>				
		N/O		0
		N/C		0
Locking facility				Lockable in the 0 (Off) position
Degree of Protection				Front IP65
Design				rear mounting 
Contact sequence				
Function				
<b>Motor rating AC-23A, 50 - 60 Hz</b>				
400 V	P		kW	45
Rated uninterrupted current	I <sub>u</sub>		A	125

## Technical data

### General

Standards				IEC/EN 60947, VDE 0660, IEC/EN 60204, CSA, UL Switch-disconnector according to IEC/EN 60947-3
Climatic proofing				Damp heat, constant, to IEC 60068-2-78 Damp heat, cyclic, to IEC 60068-2-30
Ambient temperature				
Open			°C	-25 - +50
Enclosed			°C	-25 - +40
Overvoltage category/pollution degree				III/3
Rated impulse withstand voltage	U <sub>imp</sub>		V AC	8000
Mounting position				As required
Protection against direct contact when actuated from front (EN 50274)				Finger and back-of-hand proof

## Contacts

<b>Mechanical variables</b>			
Number of poles			3 pole + N
Auxiliary contacts			
		N/O	0
		N/C	0
<b>Electrical characteristics</b>			
Rated operational voltage	$U_e$	V AC	690
Rated uninterrupted current	$I_u$	A	125
Note on rated uninterrupted current $I_u$			Rated uninterrupted current $I_u$ is specified for max. cross-section.
<b>Load rating with intermittent operation, class 12</b>			
AB 25 % DF		$\times I_e$	2
AB 40 % DF		$\times I_e$	1.6
AB 60 % DF		$\times I_e$	1.3
<b>Short-circuit rating</b>			
Fuse		A gG/gL	125
Rated short-time withstand current (1 s current)	$I_{cw}$	$A_{rms}$	2500
Note on rated short-time withstand current $I_{cw}$			Current for a time of 1 second
Rated conditional short-circuit current	$I_q$	kA	30

## Switching capacity

cos $\phi$ rated making capacity as per IEC 60947-3		A	850
Rated breaking capacity cos $\phi$ to IEC 60947-3		A	
230 V		A	800
400/415 V		A	750
500 V		A	650
690 V		A	340
<b>Safe isolation to EN 61140</b>			
between the contacts		V AC	440
Current heat loss per contact at $I_e$		W	8
Lifespan, mechanical	Operations	$\times 10^6$	> 0.1
Maximum operating frequency	Operations/h		50
<b>AC</b>			
<b>AC-3</b>			
Rating, motor load switch	P	kW	
220 V 230 V	P	kW	22
400 V 415 V	P	kW	37
500 V	P	kW	45
690 V	P	kW	30
Rated operational current motor load switch			
230 V	$I_e$	A	72
400V 415 V	$I_e$	A	66
500 V	$I_e$	A	58
690 V	$I_e$	A	32
<b>AC-21A</b>			
Rated operational current switch			
440 V	$I_e$	A	125
<b>AC-23A</b>			
Motor rating AC-23A, 50 - 60 Hz	P	kW	
230 V	P	kW	30
400 V 415 V	P	kW	45
500 V	P	kW	55
690 V	P	kW	37
Rated operational current motor load switch			
230 V	$I_e$	A	96

400 V 415 V	I <sub>e</sub>	A	80
500 V	I <sub>e</sub>	A	78
690 V	I <sub>e</sub>	A	39
<b>DC</b>			
DC-1, Load-break switches L/R = 1 ms			
Rated operational current	I <sub>e</sub>	A	125
Voltage per contact pair in series		V	42
DC-23A, motor load switch L/R = 15 ms			
24 V			
Rated operational current	I <sub>e</sub>	A	125
Contacts		Quantity	3
48 V			
Rated operational current	I <sub>e</sub>	A	125
Contacts		Quantity	3
60 V			
Rated operational current	I <sub>e</sub>	A	125
Contacts		Quantity	3
120 V			
Rated operational current	I <sub>e</sub>	A	40
Contacts		Quantity	3
Control circuit reliability at 24 V DC, 10 mA	Fault probability	H <sub>F</sub>	< 10 <sup>-5</sup> , < 1 fault in 100000 operations

### Terminal capacities

Solid or stranded		mm <sup>2</sup>	1 x (10 - 95) 2 x (10 - 35)
Flexible with ferrules to DIN 46228		mm <sup>2</sup>	1 x (16 - 70) 2 x (16 - 25)
Copper strip	Number of segments x width x thickness	mm	6 x 9 x 0.8 (1 flat conductor)
Terminal screw			Allen screw 5
Max. tightening torque		Nm	14

### Technical safety parameters:

<b>Notes</b>			B10 <sub>q</sub> values as per EN ISO 13849-1, table C1
--------------	--	--	---------------------------------------------------------

### Rating data for approved types

<b>Contacts</b>			
Rated operational voltage	U <sub>e</sub>	V AC	600
Rated uninterrupted current max.			
Main conducting paths			
General use	I <sub>U</sub>	A	150
Auxiliary contacts			
General Use	I <sub>U</sub>	A	10
Pilot Duty			A 600
<b>Switching capacity</b>			
Maximum motor rating			
Single-phase			
120 V AC		HP	7.5
240 V AC		HP	20
277 V AC		HP	20
Three-phase			
120 V AC		HP	15
240 V AC		HP	30
480 V AC		HP	60
600 V AC		HP	60
<b>Short Circuit Current Rating</b>			
Basic Rating		kA	10

max. Fuse	A	350, RK1
High fault rating	kA	65
max. Fuse	A	300, Class J
Terminal capacity		
Solid or flexible conductor with ferrule	AWG	3/0
Flexible	AWG	2/0
Terminal screw		Allen screw 5
Tightening torque	lb-in	125

## Design verification as per IEC/EN 61439

Technical data for design verification			
Rated operational current for specified heat dissipation	$I_n$	A	125
Heat dissipation per pole, current-dependent	$P_{vid}$	W	8
Equipment heat dissipation, current-dependent	$P_{vid}$	W	0
Static heat dissipation, non-current-dependent	$P_{vs}$	W	0
Heat dissipation capacity	$P_{diss}$	W	0
Operating ambient temperature min.		°C	-25
Operating ambient temperature max.		°C	50
IEC/EN 61439 design verification			
10.2 Strength of materials and parts			
10.2.2 Corrosion resistance			Meets the product standard's requirements.
10.2.3.1 Verification of thermal stability of enclosures			Meets the product standard's requirements.
10.2.3.2 Verification of resistance of insulating materials to normal heat			Meets the product standard's requirements.
10.2.3.3 Verification of resistance of insulating materials to abnormal heat and fire due to internal electric effects			Meets the product standard's requirements.
10.2.4 Resistance to ultra-violet (UV) radiation			Please enquire
10.2.5 Lifting			Does not apply, since the entire switchgear needs to be evaluated.
10.2.6 Mechanical impact			Does not apply, since the entire switchgear needs to be evaluated.
10.2.7 Inscriptions			Meets the product standard's requirements.
10.3 Degree of protection of ASSEMBLIES			Does not apply, since the entire switchgear needs to be evaluated.
10.4 Clearances and creepage distances			Meets the product standard's requirements.
10.5 Protection against electric shock			Does not apply, since the entire switchgear needs to be evaluated.
10.6 Incorporation of switching devices and components			Does not apply, since the entire switchgear needs to be evaluated.
10.7 Internal electrical circuits and connections			Is the panel builder's responsibility.
10.8 Connections for external conductors			Is the panel builder's responsibility.
10.9 Insulation properties			
10.9.2 Power-frequency electric strength			Is the panel builder's responsibility.
10.9.3 Impulse withstand voltage			Is the panel builder's responsibility.
10.9.4 Testing of enclosures made of insulating material			Is the panel builder's responsibility.
10.10 Temperature rise			The panel builder is responsible for the temperature rise calculation. Eaton will provide heat dissipation data for the devices.
10.11 Short-circuit rating			Is the panel builder's responsibility. The specifications for the switchgear must be observed.
10.12 Electromagnetic compatibility			Is the panel builder's responsibility. The specifications for the switchgear must be observed.
10.13 Mechanical function			The device meets the requirements, provided the information in the instruction leaflet (IL) is observed.

## Technical data ETIM 6.0

Low-voltage industrial components (EG000017) / Switch disconnecter (EC000216)			
Electric engineering, automation, process control engineering / Low-voltage switch technology / Off-load switch, circuit breaker, control switch / Switch disconnecter (ecl@ss8.1-27-37-14-03 [AKF060010])			
Version as main switch			Yes
Version as maintenance-/service switch			Yes
Version as safety switch			No
Version as emergency stop installation			Yes
Version as reversing switch			No

Max. rated operation voltage Ue AC	V	690
Rated operating voltage	V	690 - 690
Rated permanent current Iu	A	125
Rated permanent current at AC-21, 400 V	A	125
Rated operation power at AC-3, 400 V	kW	37
Rated short-time withstand current Icw	kA	2.5
Rated operation power at AC-23, 400 V	kW	45
Switching power at 400 V	kW	45
Conditioned rated short-circuit current Iq	kA	30
Number of poles		4
Number of auxiliary contacts as normally closed contact		0
Number of auxiliary contacts as normally open contact		0
Number of auxiliary contacts as change-over contact		0
Motor drive optional		No
Motor drive integrated		No
Voltage release optional		No
Device construction		Built-in device fixed built-in technique
Suitable for ground mounting		No
Suitable for front mounting 4-hole		No
Suitable for front mounting center		No
Suitable for distribution board installation		No
Suitable for intermediate mounting		Yes
Colour control element		Red
Type of control element		Door coupling rotary drive
Interlockable		Yes
Type of electrical connection of main circuit		Frame clamp
Degree of protection (IP), front side		IP65

## Approvals

Product Standards		UL 508; CSA-C22.2 No. 14-05; CSA-C22.2 No. 94; IEC/EN 60947-3; CE marking
UL File No.		E36332
UL Category Control No.		NLRV, NLRV7
CSA File No.		223805
CSA Class No.		3211-05
North America Certification		UL listed, CSA certified
Suitable for		Branch circuits, suitable as motor disconnect
Degree of Protection		IEC: IP65; UL/CSA Type 1, 12

## Dimensions

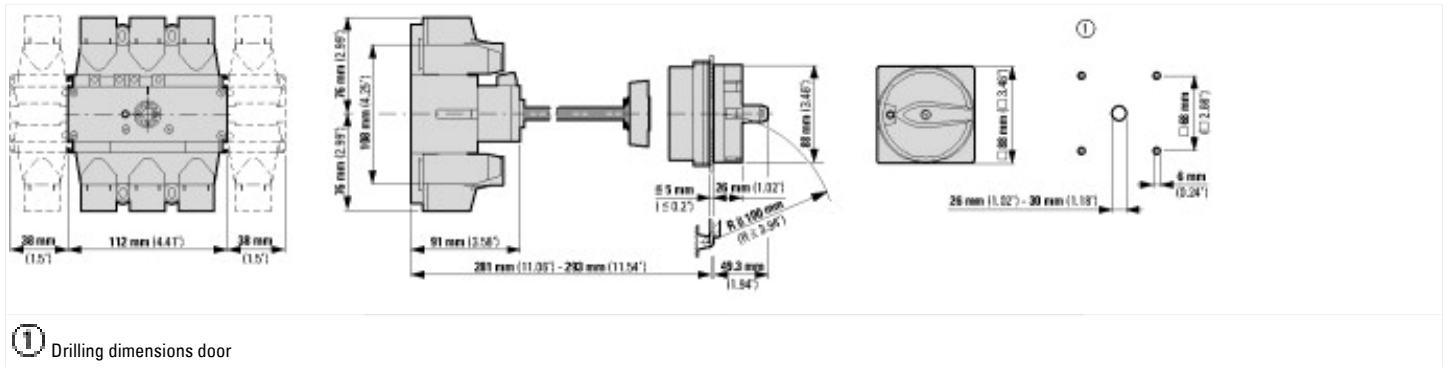



**$d = 4 - 8 \text{ mm}$**

**$b + d \leq 47 \text{ mm}$**

**$d = 0.16 - 0.31''$**

**$b + d \leq 1.85''$**

 3 padlocks

### Additional product information (links)

#### IL03802011Z Cam Switch: Main switch, On-Off-switch

IL03802011Z Cam Switch: Main switch, On-Off-switch	<a href="ftp://ftp.moeller.net/DOCUMENTATION/AWA_INSTRUCTIONS/IL03802011Z2016_05.pdf">ftp://ftp.moeller.net/DOCUMENTATION/AWA_INSTRUCTIONS/IL03802011Z2016_05.pdf</a>
Technical overview cam switch, switch-disconnector	<a href="http://de.ecat.moeller.net/flip-cat/?edition=HPLTEv1&amp;startpage=4.2">http://de.ecat.moeller.net/flip-cat/?edition=HPLTEv1&amp;startpage=4.2</a>
System overview cam switch T	<a href="http://de.ecat.moeller.net/flip-cat/?edition=HPLTEv1&amp;startpage=4.4">http://de.ecat.moeller.net/flip-cat/?edition=HPLTEv1&amp;startpage=4.4</a>
System overview switch-disconnector P	<a href="http://de.ecat.moeller.net/flip-cat/?edition=HPLTEv1&amp;startpage=4.6">http://de.ecat.moeller.net/flip-cat/?edition=HPLTEv1&amp;startpage=4.6</a>
Key to part numbers Cam switch	<a href="http://de.ecat.moeller.net/flip-cat/?edition=HPLTEv1&amp;startpage=4.8">http://de.ecat.moeller.net/flip-cat/?edition=HPLTEv1&amp;startpage=4.8</a>
Key to part numbers Switch-disconnector	<a href="http://de.ecat.moeller.net/flip-cat/?edition=HPLTEv1&amp;startpage=4.8">http://de.ecat.moeller.net/flip-cat/?edition=HPLTEv1&amp;startpage=4.8</a>
Switches for ATEX	<a href="http://www.coopercrouse-hinds.eu/en/products/25-ex-safety-and-main-current-switches.html">http://www.coopercrouse-hinds.eu/en/products/25-ex-safety-and-main-current-switches.html</a>