





Circuit-breaker, 3p, 45A

Part no. NZMN2-AF45-NA
Article no. 269176

Similar to illustration

Delivery program

| | | | | |
|---|---------------------------------------|----|--|--|
| Product range | | | | Circuit-breaker |
| Protective function | | | | System and cable protection |
| Standard/Approval | | | | UL/CSA, IEC |
| Release system | | | | Thermomagnetic release |
| Installation type | | | | Fixed |
| Description | | | | Switches conform to UL/CSA as well as the IEC regulations. IEC switching performance values are contained on the rating plate. Fixed overload releases I _r |
| Frame size | | | | NZM2 |
| Number of poles | | | | 3 pole |
| Standard equipment | | | | Screw connection |
| Switching capacity | | | | |
| SCCR 480 V 60 Hz | I _{cu} | kA | | 35 |
| SCCR 600V/347 V 60 Hz | I _{cu} | kA | | 25 |
| Rated current = rated uninterrupted current | | | | |
| Rated current = rated uninterrupted current | I _n = I _u | A | | 45 |
| Setting range | | | | |
| Overload trip | | | | |
|  | I _r | A | | 45 - 45 |
| Short-circuit releases | | | | |
|  | | | | |
| Non-delayed | I _i = I _n x ... | | | Approx. 6 - 10 |
|  | | | | |

Technical data

| | | | | |
|---|--|------|--|--|
| General | | | | |
| Standards | | | | IEC/EN 60947 |
| Protection against direct contact | | | | Finger and back of hand proof to VDE 0106 Part 100 |
| Climatic proofing | | | | Damp heat, constant, to IEC 60068-2-78 Damp heat, cyclic, to IEC 60068-2-30 |
| Ambient temperature | | | | |
| Ambient temperature, storage | | °C | | - 40 - + 70 |
| Operation | | °C | | -25 - +70 |
| Mechanical shock resistance (10 ms half-sinusoidal shock) according to IEC 60068-2-27 | | g | | 20 (half-sinusoidal shock 20 ms) |
| Safe isolation to EN 61140 | | | | |
| Between auxiliary contacts and main contacts | | V AC | | 500 |
| between the auxiliary contacts | | V AC | | 300 |
| Weight | | kg | | 2.345 |
| Mounting position | | | | |
| Mounting position | | | | Vertical and 90° in all directions |



With residual-current release XFI:

- NZM1, N1, NZM2, N2: vertical and 90° in all directions
- with plug-in adapter elements
- NZM1, N1, NZM2, N2: vertical, 90° right/left
- with withdrawable unit:
- NZM3, N3: vertical, 90° left
- NZM4, N4: vertical
- with remote operator:
- NZM2, N(S)2, NZM3, N(S)3, NZM4, N(S)4: vertical and 90° in all directions

| | | |
|--|--|--|
| Direction of incoming supply | | as required |
| Degree of protection | | |
| Device | | In the operating controls area: IP20 (basic degree of protection) |
| Enclosures | | With insulating surround: IP40 With door coupling rotary handle: IP66 |
| Terminations | | Tunnel terminal: IP10 Phase isolator and strip terminal: IP00 |
| Other technical data (sheet catalogue) | | Weight Temperature dependency, Derating Effective power loss |

Circuit-breakers

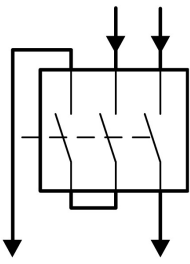
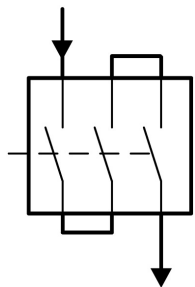
| | | | |
|---------------------------------------|-----------|------|---|
| Rated surge voltage invariability | U_{imp} | | |
| Main contacts | | V | 8000 |
| Auxiliary contacts | | V | 6000 |
| Rated operational voltage | U_e | V AC | 690 |
| Rated operational voltage | U_e | V DC | 750 |
| | | | <p>Details apply for 3 pole system protection circuit-breaker with thermomagnetic release NZMN(H)1(2)(3)-A... to 500 A.</p> <p>For rated operating voltage switching via 3 contacts:</p> <p>DC correction factor for instantaneous release response value: NZM1: 1.25, NZM2: 1.35, NZM3: 1.45</p> <p>Set value for I_i at DC = set value I_i AC/correction factor DC</p> <p>Switching of one pole via two series contacts</p>  <p>Switching of one pole via three series contacts</p>  |
| Overvoltage category/pollution degree | | | III/3 |
| Rated insulation voltage | U_i | V | 1000 |
| Use in unearthed supply systems | | V | ≦ 690 |

Switching capacity

| | | | |
|--|----------|----|-----|
| Rated short-circuit making capacity | I_{cm} | | |
| 240 V | I_{cm} | kA | 187 |
| 400/415 V | I_{cm} | kA | 105 |
| 440 V 50/60 Hz | I_{cm} | kA | 74 |
| 525 V 50/60 Hz | I_{cm} | kA | 53 |
| 690 V 50/60 Hz | I_c | kA | 40 |
| Rated short-circuit breaking capacity I_{cn} | I_{cn} | | |
| Icu to IEC/EN 60947 test cycle O-t-CO | I_{cu} | kA | |
| 240 V 50/60 Hz | I_{cu} | kA | 85 |
| 400/415 V 50/60 Hz | I_{cu} | kA | 50 |
| 440 V 50/60 Hz | I_{cu} | kA | 35 |

| | | | |
|---|-----------------|---------|---|
| 525 V 50/60 Hz | I _{cu} | kA | 25 |
| 690 V 50/60 Hz | I _{cu} | kA | 20 |
| 500 V DC | I _{cu} | kA | 30 |
| 750 V DC | I _{cu} | kA | 30 |
| I _{cs} to IEC/EN 60947 test cycle O-t-CO-t-CO | I _{cs} | kA | |
| 240 V 50/60 Hz | I _{cs} | kA | 85 |
| 400/415 V 50/60 Hz | I _{cs} | kA | 50 |
| 440 V 50/60 Hz | I _{cs} | kA | 35 |
| 525 V 50/60 Hz | I _{cs} | kA | 25 |
| 690 V 50/60 Hz | I _{cs} | kA | 5 |
| Maximum low-voltage h.b.c. fuse | | A gG/gL | 355 |
| | | | Maximum back-up fuse, if the expected short-circuit currents at the installation location exceed the switching capacity of the circuit-breaker. |
| Technical data that diverge from products for the IEC market | | | |
| Switching capacity of NA switches (UL489, CSA 22.2 No. 5.1) | | | |
| Short-circuit current rating SCCR | | | |
| SCCR 240 V 60 Hz | I _{cu} | kA | 85 |
| SCCR 480 V 60 Hz | I _{cu} | kA | 35 |
| SCCR 600V/347 V 60 Hz | I _{cu} | kA | 25 |
| Rated short-time withstand current | | | |
| t = 0.3 s | I _{cw} | kA | 1.9 |
| t = 1 s | I _{cw} | kA | 1.9 |
| Utilization category to IEC/EN 60947-2 | | | |
| A | | | |
| Rated making and breaking capacity | | | |
| Rated operational current | | | |
| | I _e | A | |
| AC-1 | | | |
| 400/415 V 50/60 Hz | I _e | A | 300 |
| 415 V | I _e | A | 300 |
| 690 V 50/60 Hz | I _e | A | 45 |
| AC--3 | | | |
| 400/415 V 50/60 Hz | I _e | A | 45 |
| 690 V 50/60 Hz | I _e | A | 45 |
| DC-1 | | | |
| 500 V DC | I _e | CSA | 45 |
| 750 V DC | I _e | CSA | 45 |
| DC - 3 | | | |
| 500 V DC | I _e | CSA | 45 |
| 750 V DC | I _e | CSA | 45 |
| Lifespan, mechanical(of which max. 50 % trip by shunt/undervoltage release) | | | |
| Operations | | | |
| 20000 | | | |
| Lifespan, electrical | | | |
| AC-1 | | | |
| 400 V 50/60 Hz | Operations | | 10000 |
| 690 V 50/60 Hz | Operations | | 7500 |
| AC--3 | | | |
| 400 V 50/60 Hz | Operations | | 6500 |
| 415 V 50/60 Hz | Operations | | 6500 |
| 690 V 50/60 Hz | Operations | | 5000 |
| DC-1 | | | |
| 500 V DC | Operations | | 3500 |
| 750 V DC | Operations | | 3500 |
| DC - 3 | | | |
| 500 V DC | Operations | | 3000 |
| 750 V DC | Operations | | 3000 |
| Max. operating frequency | | | |
| | | Ops/h | 120 |
| Total downtime in a short-circuit | | | |
| | | ms | < 10 |

Terminal capacity

| Standard equipment | | | Screw connection |
|---|------|-----------------|------------------------------------|
| Round copper conductor | | | |
| Box terminal | | | |
| Solid | | mm ² | 1 x (12 ... 6) |
| Stranded | | mm ² | 1 x (4 ... 350) |
| Tunnel terminal | | | |
| Solid | | mm ² | 1 x 16 |
| Stranded | | mm ² | |
| Stranded | | mm ² | 1 x (4 ... 350) |
| Bolt terminal and rear-side connection | | | |
| Direct on the switch | | | |
| Solid | | mm ² | 1 x (11 ... 6) |
| Stranded | | mm ² | 1 x (4 ... 3/0) |
| Al conductors, Cu cable | | | |
| Solid | | mm ² | 1 x 16 |
| Bolt terminal and rear-side connection | | | |
| Flat copper strip, with holes | min. | mm | 2 x 16 x 0.8 |
| Flat copper strip, with holes | max. | mm | 10 x 16 x 0.8 |
| Cu strip (number of segments x width x segment thickness) | | | |
| Box terminal | | | |
| | min. | mm | 2 x 9 x 0.8 |
| | max. | mm | 10 x 16 x 0.8 |
| Bolt terminal and rear-side connection | | | |
| Flat copper strip, with holes | min. | mm | 2 x 16 x 0.8 |
| Flat copper strip, with holes | max. | mm | 10 x 16 x 0.8 |
| Copper busbar (width x thickness) | mm | | |
| Bolt terminal and rear-side connection | | | |
| Screw connection | | | M8 |
| Direct on the switch | | | |
| | min. | mm | 16 x 5 |
| | max. | mm | 20 x 5 |
| Control cables | | | |
| | | mm ² | 1 x (18 ... 14) 2 x (18 ... 16) |

Design verification as per IEC/EN 61439

| Technical data for design verification | | | |
|--|------------------|----|--|
| Rated operational current for specified heat dissipation | I _n | A | 45 |
| Equipment heat dissipation, current-dependent | P _{vid} | W | 13.79 |
| Operating ambient temperature min. | | °C | -25 |
| Operating ambient temperature max. | | °C | 70 |
| IEC/EN 61439 design verification | | | |
| 10.2 Strength of materials and parts | | | |
| 10.2.2 Corrosion resistance | | | Meets the product standard's requirements. |
| 10.2.3.1 Verification of thermal stability of enclosures | | | Meets the product standard's requirements. |
| 10.2.3.2 Verification of resistance of insulating materials to normal heat | | | Meets the product standard's requirements. |
| 10.2.3.3 Verification of resistance of insulating materials to abnormal heat and fire due to internal electric effects | | | Meets the product standard's requirements. |
| 10.2.4 Resistance to ultra-violet (UV) radiation | | | Meets the product standard's requirements. |
| 10.2.5 Lifting | | | Does not apply, since the entire switchgear needs to be evaluated. |
| 10.2.6 Mechanical impact | | | Does not apply, since the entire switchgear needs to be evaluated. |
| 10.2.7 Inscriptions | | | Meets the product standard's requirements. |
| 10.3 Degree of protection of ASSEMBLIES | | | Does not apply, since the entire switchgear needs to be evaluated. |

| | | |
|--|--|--|
| 10.4 Clearances and creepage distances | | Meets the product standard's requirements. |
| 10.5 Protection against electric shock | | Does not apply, since the entire switchgear needs to be evaluated. |
| 10.6 Incorporation of switching devices and components | | Does not apply, since the entire switchgear needs to be evaluated. |
| 10.7 Internal electrical circuits and connections | | Is the panel builder's responsibility. |
| 10.8 Connections for external conductors | | Is the panel builder's responsibility. |
| 10.9 Insulation properties | | |
| 10.9.2 Power-frequency electric strength | | Is the panel builder's responsibility. |
| 10.9.3 Impulse withstand voltage | | Is the panel builder's responsibility. |
| 10.9.4 Testing of enclosures made of insulating material | | Is the panel builder's responsibility. |
| 10.10 Temperature rise | | The panel builder is responsible for the temperature rise calculation. Eaton will provide heat dissipation data for the devices. |
| 10.11 Short-circuit rating | | Is the panel builder's responsibility. The specifications for the switchgear must be observed. |
| 10.12 Electromagnetic compatibility | | Is the panel builder's responsibility. The specifications for the switchgear must be observed. |
| 10.13 Mechanical function | | The device meets the requirements, provided the information in the instruction leaflet (IL) is observed. |

Technical data ETIM 6.0

| | | |
|--|----|--|
| Low-voltage industrial components (EG000017) / Power circuit-breaker for trafo/generator/installation prot. (EC000228) | | |
| Electric engineering, automation, process control engineering / Low-voltage switch technology / Circuit breaker (LV < 1 kV) / Circuit breaker for power transformer, generator and system protection (ecl@ss8.1-27-37-04-09 [AJZ716010]) | | |
| Rated permanent current I _u | A | 45 |
| Rated voltage | V | 690 - 690 |
| Rated short-circuit breaking capacity I _{cu} at 400 V, 50 Hz | kA | 50 |
| Overload release current setting | A | 45 - 45 |
| Adjustment range short-term delayed short-circuit release | A | 0 - 0 |
| Adjustment range undelayed short-circuit release | A | 300 - 500 |
| Integrated earth fault protection | | No |
| Type of electrical connection of main circuit | | Screw connection |
| Device construction | | Built-in device fixed built-in technique |
| Suitable for DIN rail (top hat rail) mounting | | No |
| DIN rail (top hat rail) mounting optional | | Yes |
| Number of auxiliary contacts as normally closed contact | | 0 |
| Number of auxiliary contacts as normally open contact | | 0 |
| Number of auxiliary contacts as change-over contact | | 0 |
| Switched-off indicator available | | No |
| With under voltage release | | No |
| Number of poles | | 3 |
| Position of connection for main current circuit | | Front side |
| Type of control element | | Rocker lever |
| Complete device with protection unit | | Yes |
| Motor drive integrated | | No |
| Motor drive optional | | Yes |
| Degree of protection (IP) | | IP20 |

Approvals

| | | |
|--------------------------------------|--|---|
| Product Standards | | UL 489; CSA-C22.2 No. 5-09; IEC 60947-2; CE marking |
| UL File No. | | E31593 |
| UL Category Control No. | | DIVQ |
| CSA File No. | | 022086 |
| CSA Class No. | | 1432-01 |
| North America Certification | | UL listed, CSA certified |
| Specially designed for North America | | Yes |
| Suitable for | | Feeder circuits, branch circuits |
| Current Limiting Circuit-Breaker | | Yes |
| Max. Voltage Rating | | 600Y/347 V, 480 V |

Characteristics

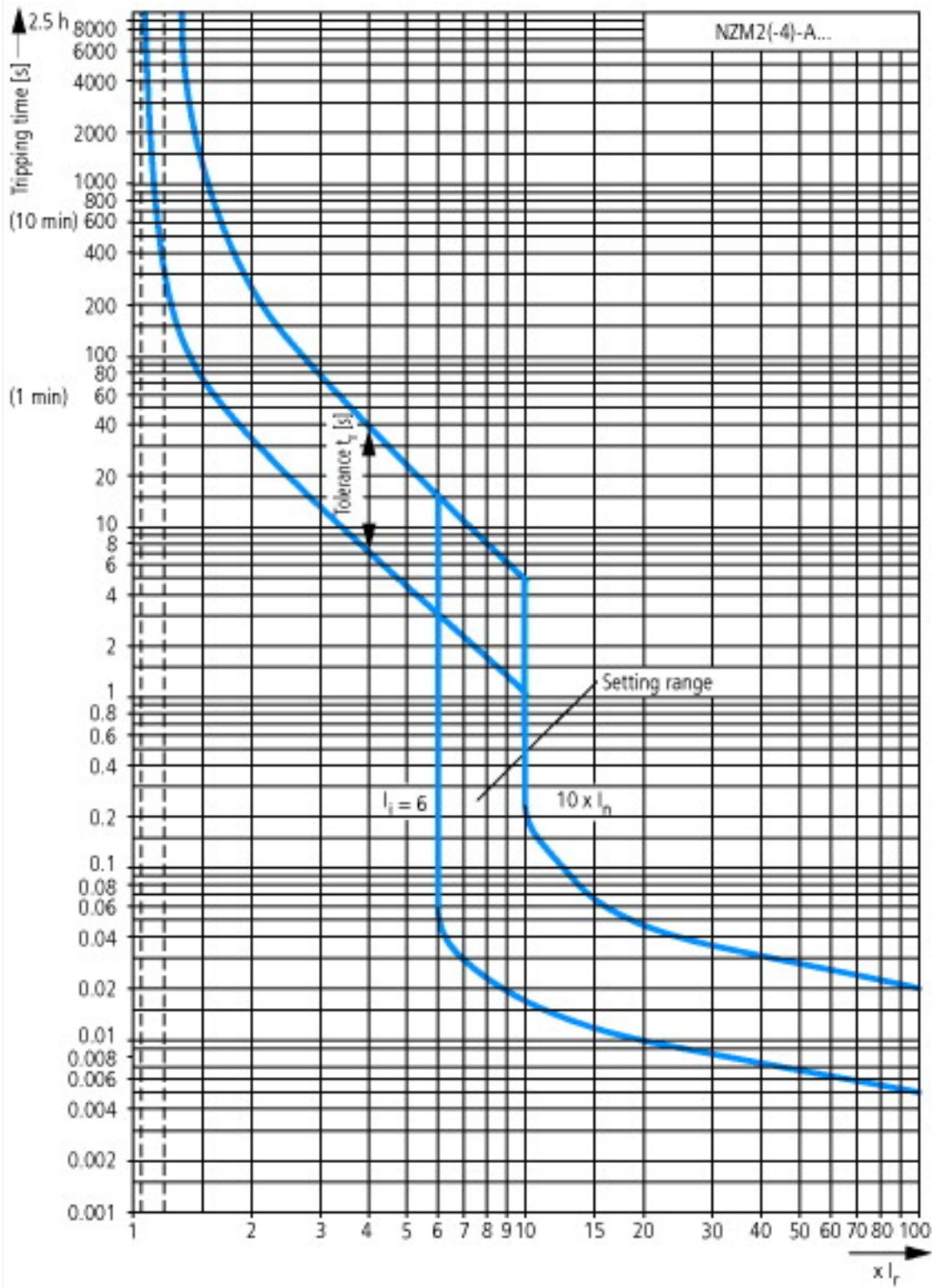

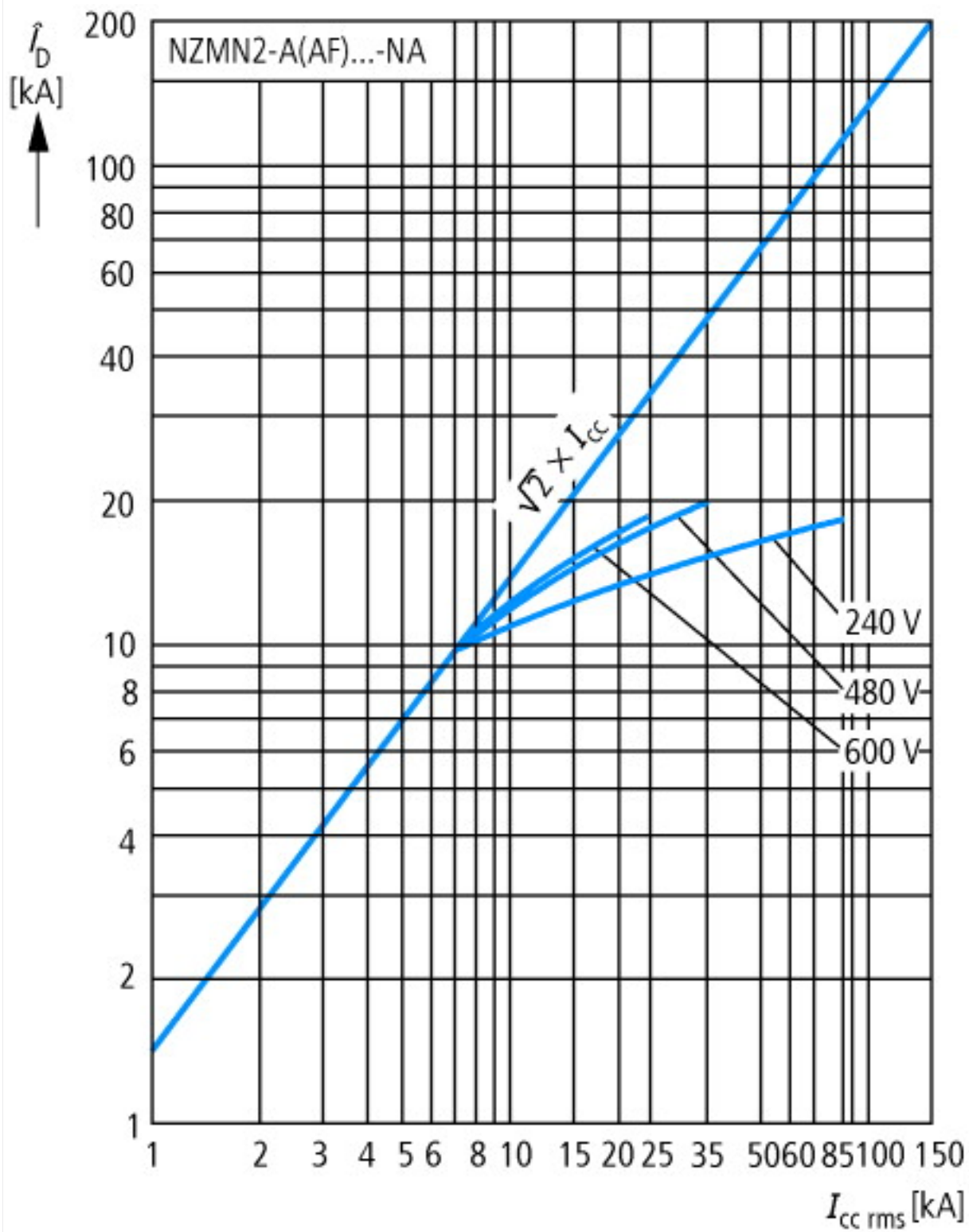

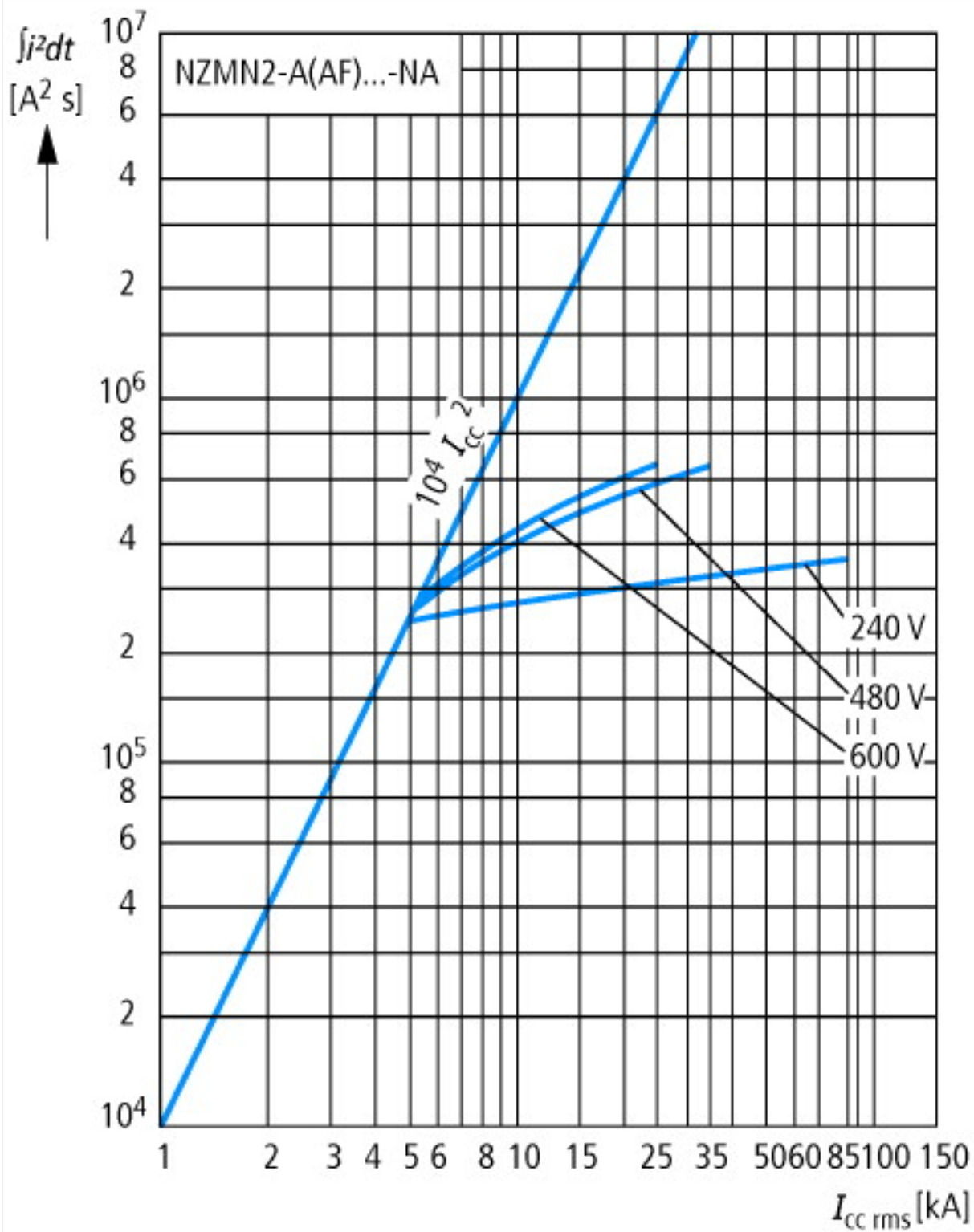

Dimensions

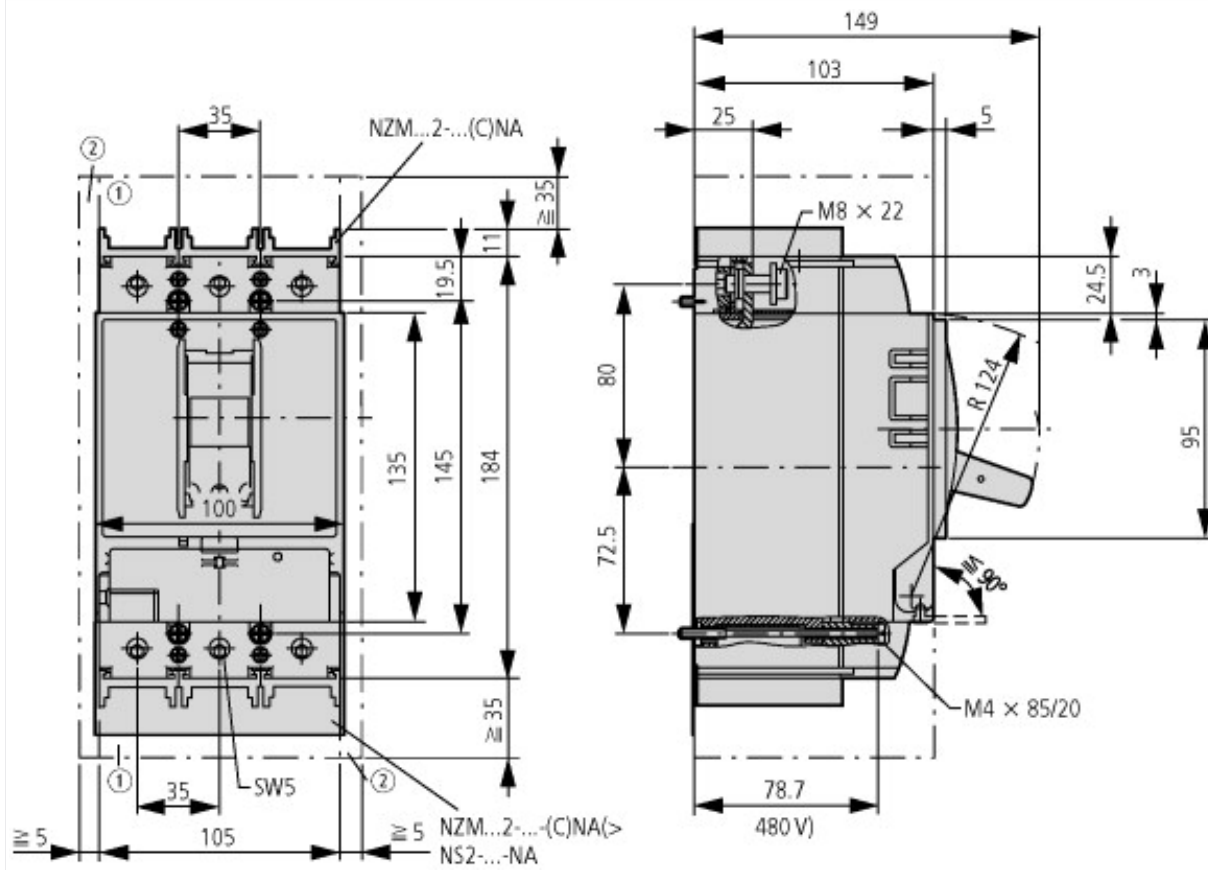

- ① Blow out area, minimum clearance to adjacent parts
- ② Minimum clearance to adjacent parts



Additional product information (links)

IL01206006Z (AWA1230-1916) Circuit-Breaker, basic unit

IL01206006Z (AWA1230-1916) Circuit-Breaker, basic unit ftp://ftp.moeller.net/DOCUMENTATION/AWA_INSTRUCTIONS/IL01206006Z2015_11.pdf

Weight <http://ecat.moeller.net/flip-cat/?edition=HPLEN&startpage=17.171>

Temperature dependency, Derating <http://ecat.moeller.net/flip-cat/?edition=HPLEN&startpage=17.172>

Effective power loss <http://ecat.moeller.net/flip-cat/?edition=HPLEN&startpage=17.174>