





Circuit-breaker, 3p, 25A

Part no. NZMN1-AF25-NA
Article no. 281566

Similar to illustration

Delivery program

Product range				Circuit-breaker
Protective function				System and cable protection
Standard/Approval				UL/CSA, IEC
Release system				Thermomagnetic release
Installation type				Fixed
Description				Switches conform to UL/CSA as well as the IEC regulations. IEC switching performance values are contained on the rating plate. Fixed overload releases I _r
Frame size				NZM1
Number of poles				3 pole
Standard equipment				Box terminal
Switching capacity				
SCCR 480 V 60 Hz	I _{cu}	kA		35
Rated current = rated uninterrupted current				
Rated current = rated uninterrupted current	I _n = I _u	A		25
Setting range				
Overload trip				
	I _r	A		25 - 25
Short-circuit releases				
				
Non-delayed	I _i = I _n × ...			350 A fixed
				

Technical data

General				
Standards				IEC/EN 60947
Protection against direct contact				Finger and back of hand proof to VDE 0106 Part 100
Climatic proofing				Damp heat, constant, to IEC 60068-2-78 Damp heat, cyclic, to IEC 60068-2-30
Ambient temperature				
Ambient temperature, storage		°C		- 40 - + 70
Operation		°C		-25 - +70
Mechanical shock resistance (10 ms half-sinusoidal shock) according to IEC 60068-2-27		g		20 (half-sinusoidal shock 20 ms)
Safe isolation to EN 61140				
Between auxiliary contacts and main contacts		V AC		500
between the auxiliary contacts		V AC		300
Mounting position				
Mounting position				Vertical and 90° in all directions



With residual-current release XFI:

- NZM1, N1, NZM2, N2: vertical and 90° in all directions

with plug-in adapter elements

- NZM1, N1, NZM2, N2: vertical, 90° right/left

with withdrawable unit:

- NZM3, N3: vertical, 90° left
- NZM4, N4: vertical

with remote operator:

- NZM2, N(S)2, NZM3, N(S)3, NZM4, N(S)4: vertical and 90° in all directions

Direction of incoming supply		as required
Degree of protection		
Device		In the operating controls area: IP20 (basic degree of protection)
Enclosures		With insulating surround: IP40 With door coupling rotary handle: IP66
Terminations		Tunnel terminal: IP10 Phase isolator and strip terminal: IP00
Other technical data (sheet catalogue)		Weight Temperature dependency, Derating Effective power loss

Circuit-breakers

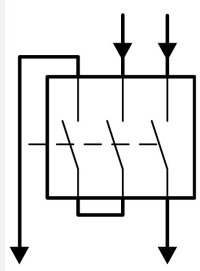
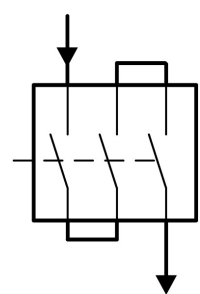
Rated surge voltage invariability	U_{imp}		
Main contacts		V	6000
Auxiliary contacts		V	6000
Rated operational voltage	U_e	V AC	690
Rated operational voltage	U_e	V DC	500
			<p>Details apply for 3 pole system protection circuit-breaker with thermomagnetic release NZMN(H)1(2)(3)-A... to 500 A.</p> <p>For rated operating voltage switching via 3 contacts:</p> <p>DC correction factor for instantaneous release response value: NZM1: 1.25, NZM2: 1.35, NZM3: 1.45</p> <p>Set value for I_i at DC = set value I_i AC/correction factor DC</p> <p>Switching of one pole via two series contacts</p>  <p>Switching of one pole via three series contacts</p> 
Overvoltage category/pollution degree			III/3
Rated insulation voltage	U_i	V	690
Use in unearthed supply systems		V	≅ 690

Switching capacity

Rated short-circuit making capacity	I_{cm}		
240 V	I_{cm}	kA	187
400/415 V	I_{cm}	kA	105
440 V 50/60 Hz	I_{cm}	kA	74
525 V 50/60 Hz	I_{cm}	kA	40
690 V 50/60 Hz	I_c	kA	17
Rated short-circuit breaking capacity I_{cn}	I_{cn}		
Icu to IEC/EN 60947 test cycle O-t-CO	I_{cu}	kA	
240 V 50/60 Hz	I_{cu}	kA	85
400/415 V 50/60 Hz	I_{cu}	kA	50
440 V 50/60 Hz	I_{cu}	kA	35

525 V 50/60 Hz	I _{cu}	kA	20
690 V 50/60 Hz	I _{cu}	kA	10
500 V DC	I _{cu}	kA	15
I _{cs} to IEC/EN 60947 test cycle 0-t-CO-t-CO	I _{cs}	kA	
240 V 50/60 Hz	I _{cs}	kA	85
400/415 V 50/60 Hz	I _{cs}	kA	50
440 V 50/60 Hz	I _{cs}	kA	35
525 V 50/60 Hz	I _{cs}	kA	10
690 V 50/60 Hz	I _{cs}	kA	7.5
Maximum low-voltage h.b.c. fuse		A gG/gL	200
			Maximum back-up fuse, if the expected short-circuit currents at the installation location exceed the switching capacity of the circuit-breaker.
Technical data that diverge from products for the IEC market			
Switching capacity of NA switches (UL489, CSA 22.2 No. 5.1)			
Short-circuit current rating SCCR			
SCCR 240 V 60 Hz	I _{cu}	kA	85
SCCR 480 V 60 Hz	I _{cu}	kA	35
Utilization category to IEC/EN 60947-2			A
Rated making and breaking capacity			
Rated operational current	I _e	A	
AC-1			
400/415 V 50/60 Hz	I _e	A	160
415 V	I _e	A	125
690 V 50/60 Hz	I _e	A	25
AC--3			
400/415 V 50/60 Hz	I _e	A	25
690 V 50/60 Hz	I _e	A	25
DC-1			
500 V DC	I _e	CSA	25
DC - 3			
500 V DC	I _e	CSA	25
Lifespan, mechanical(of which max. 50 % trip by shunt/undervoltage release)	Operations		20000
Lifespan, electrical			
AC-1			
400 V 50/60 Hz	Operations		10000
690 V 50/60 Hz	Operations		7500
AC--3			
400 V 50/60 Hz	Operations		7500
415 V 50/60 Hz	Operations		7500
690 V 50/60 Hz	Operations		5000
DC-1			
500 V DC		Operations	30000
DC - 3			
500 V DC	Operations		5000
Max. operating frequency		Ops/h	120
Total downtime in a short-circuit		ms	< 10
Terminal capacity			
Standard equipment			Box terminal
Round copper conductor			
Box terminal			
Solid		mm ²	1 x (12 ... 6)
Stranded		mm ²	1 x (25 - 70) 2 x 25
Tunnel terminal			
Solid		mm ²	1 x (16 - 95)

Stranded		mm ²	
Stranded		mm ²	1 x (4 ... 3/0)
Bolt terminal and rear-side connection			
Direct on the switch			
Solid		mm ²	1 x (12 ... 6) 2 x (9 ... 6)
Stranded		mm ²	1 x (4 ... 2/0)
Al conductors, Cu cable			
Solid		mm ²	1 x 16
Cu strip (number of segments x width x segment thickness)			
Box terminal			
	min.	mm	2 x 9 x 0.8
	max.	mm	9 x 9 x 0.8
Copper busbar (width x thickness)		mm	
Bolt terminal and rear-side connection			
Screw connection			M8
Direct on the switch			
	min.	mm	12 x 5
	max.	mm	16 x 5
Control cables			
		mm ²	1 x (18 ... 14) 2 x (18 ... 16)

Design verification as per IEC/EN 61439

Technical data for design verification			
Rated operational current for specified heat dissipation	I _n	A	25
Equipment heat dissipation, current-dependent	P _{vid}	W	8.78
Operating ambient temperature min.		°C	-25
Operating ambient temperature max.		°C	70
IEC/EN 61439 design verification			
10.2 Strength of materials and parts			
10.2.2 Corrosion resistance			Meets the product standard's requirements.
10.2.3.1 Verification of thermal stability of enclosures			Meets the product standard's requirements.
10.2.3.2 Verification of resistance of insulating materials to normal heat			Meets the product standard's requirements.
10.2.3.3 Verification of resistance of insulating materials to abnormal heat and fire due to internal electric effects			Meets the product standard's requirements.
10.2.4 Resistance to ultra-violet (UV) radiation			Meets the product standard's requirements.
10.2.5 Lifting			Does not apply, since the entire switchgear needs to be evaluated.
10.2.6 Mechanical impact			Does not apply, since the entire switchgear needs to be evaluated.
10.2.7 Inscriptions			Meets the product standard's requirements.
10.3 Degree of protection of ASSEMBLIES			Does not apply, since the entire switchgear needs to be evaluated.
10.4 Clearances and creepage distances			Meets the product standard's requirements.
10.5 Protection against electric shock			Does not apply, since the entire switchgear needs to be evaluated.
10.6 Incorporation of switching devices and components			Does not apply, since the entire switchgear needs to be evaluated.
10.7 Internal electrical circuits and connections			Is the panel builder's responsibility.
10.8 Connections for external conductors			Is the panel builder's responsibility.
10.9 Insulation properties			
10.9.2 Power-frequency electric strength			Is the panel builder's responsibility.
10.9.3 Impulse withstand voltage			Is the panel builder's responsibility.
10.9.4 Testing of enclosures made of insulating material			Is the panel builder's responsibility.
10.10 Temperature rise			The panel builder is responsible for the temperature rise calculation. Eaton will provide heat dissipation data for the devices.
10.11 Short-circuit rating			Is the panel builder's responsibility. The specifications for the switchgear must be observed.
10.12 Electromagnetic compatibility			Is the panel builder's responsibility. The specifications for the switchgear must be observed.

Technical data ETIM 6.0

Low-voltage industrial components (EG000017) / Power circuit-breaker for trafo/generator/installation prot. (EC000228)

Electric engineering, automation, process control engineering / Low-voltage switch technology / Circuit breaker (LV < 1 kV) / Circuit breaker for power transformer, generator and system protection (ecl@ss8.1-27-37-04-09 [AJZ716010])

Rated permanent current I _u	A	25
Rated voltage	V	690 - 690
Rated short-circuit breaking capacity I _{cu} at 400 V, 50 Hz	kA	50
Overload release current setting	A	25 - 25
Adjustment range short-term delayed short-circuit release	A	0 - 0
Adjustment range undelayed short-circuit release	A	350 - 350
Integrated earth fault protection		No
Type of electrical connection of main circuit		Frame clamp
Device construction		Built-in device fixed built-in technique
Suitable for DIN rail (top hat rail) mounting		No
DIN rail (top hat rail) mounting optional		Yes
Number of auxiliary contacts as normally closed contact		0
Number of auxiliary contacts as normally open contact		0
Number of auxiliary contacts as change-over contact		0
Switched-off indicator available		No
With under voltage release		No
Number of poles		3
Position of connection for main current circuit		Front side
Type of control element		Rocker lever
Complete device with protection unit		Yes
Motor drive integrated		No
Motor drive optional		No
Degree of protection (IP)		IP20

Approvals

Product Standards		UL 489; CSA-C22.2 No. 5-09; IEC 60947-2; CE marking
UL File No.		E31593
UL Category Control No.		DIVQ
CSA File No.		022086
CSA Class No.		1432-01
North America Certification		UL listed, CSA certified
Specially designed for North America		Yes
Suitable for		Feeder circuits, branch circuits
Current Limiting Circuit-Breaker		Yes
Max. Voltage Rating		480Y/277 V
Degree of Protection		IEC: IP20; UL/CSA Type: -

Characteristics

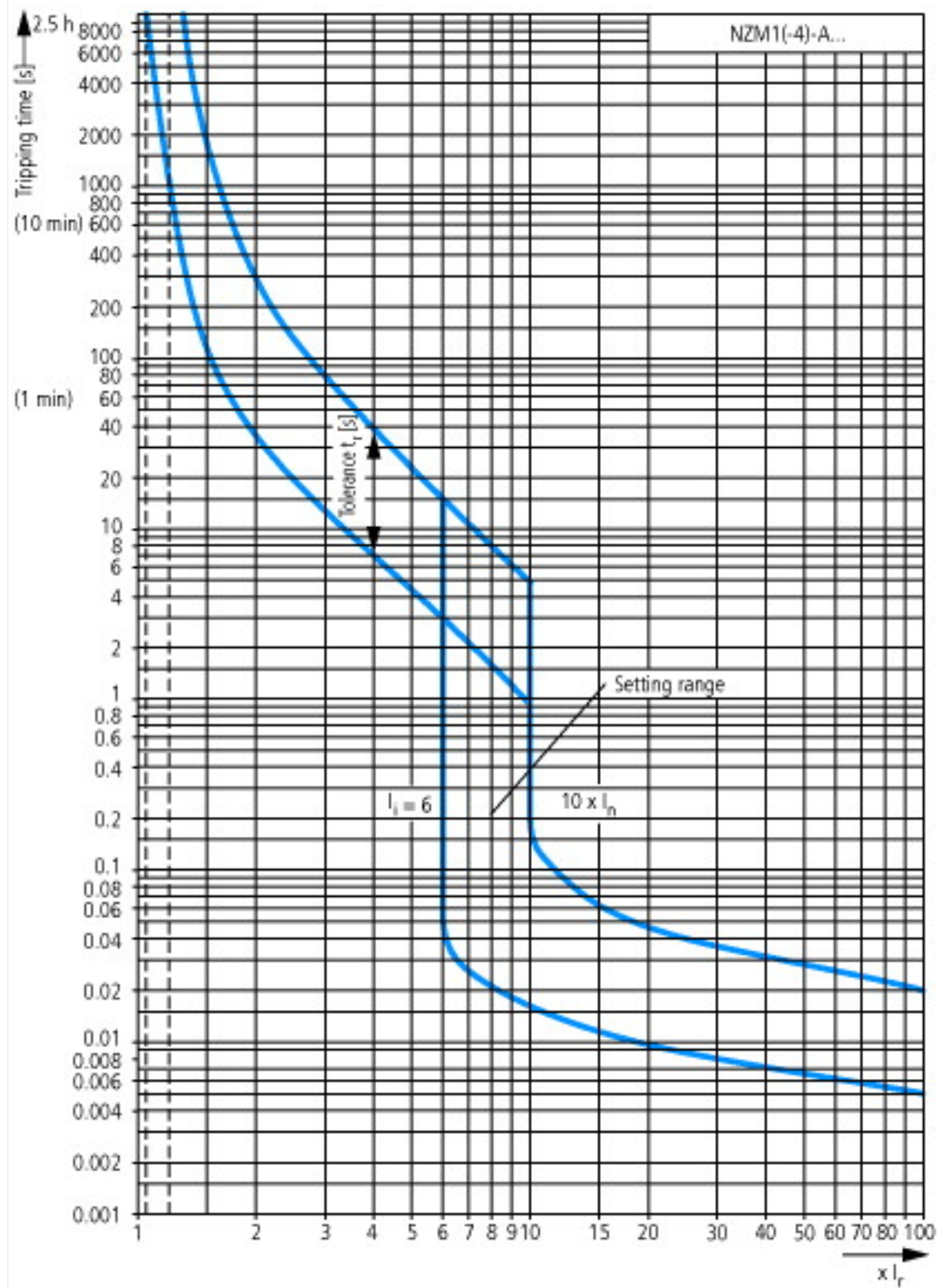

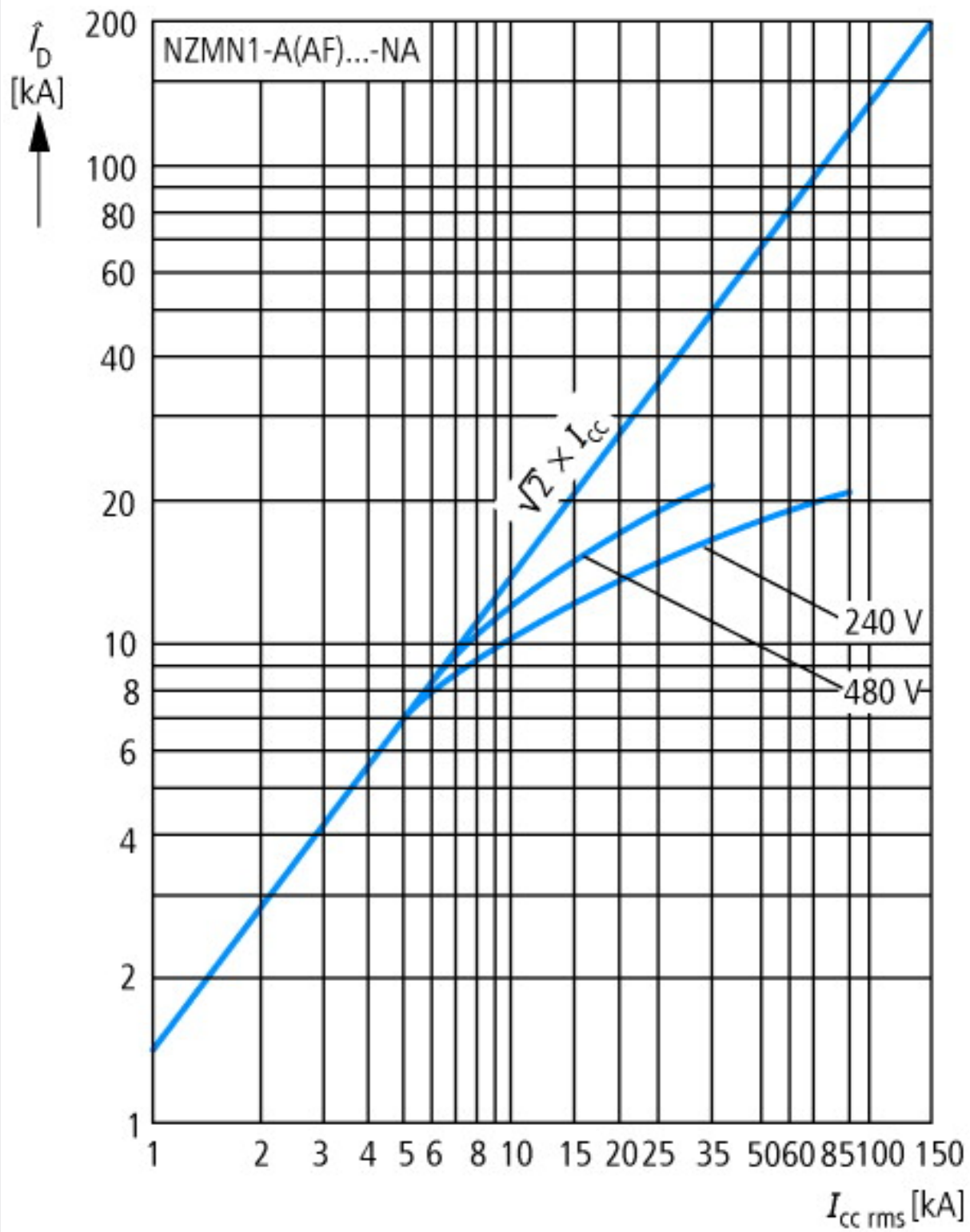

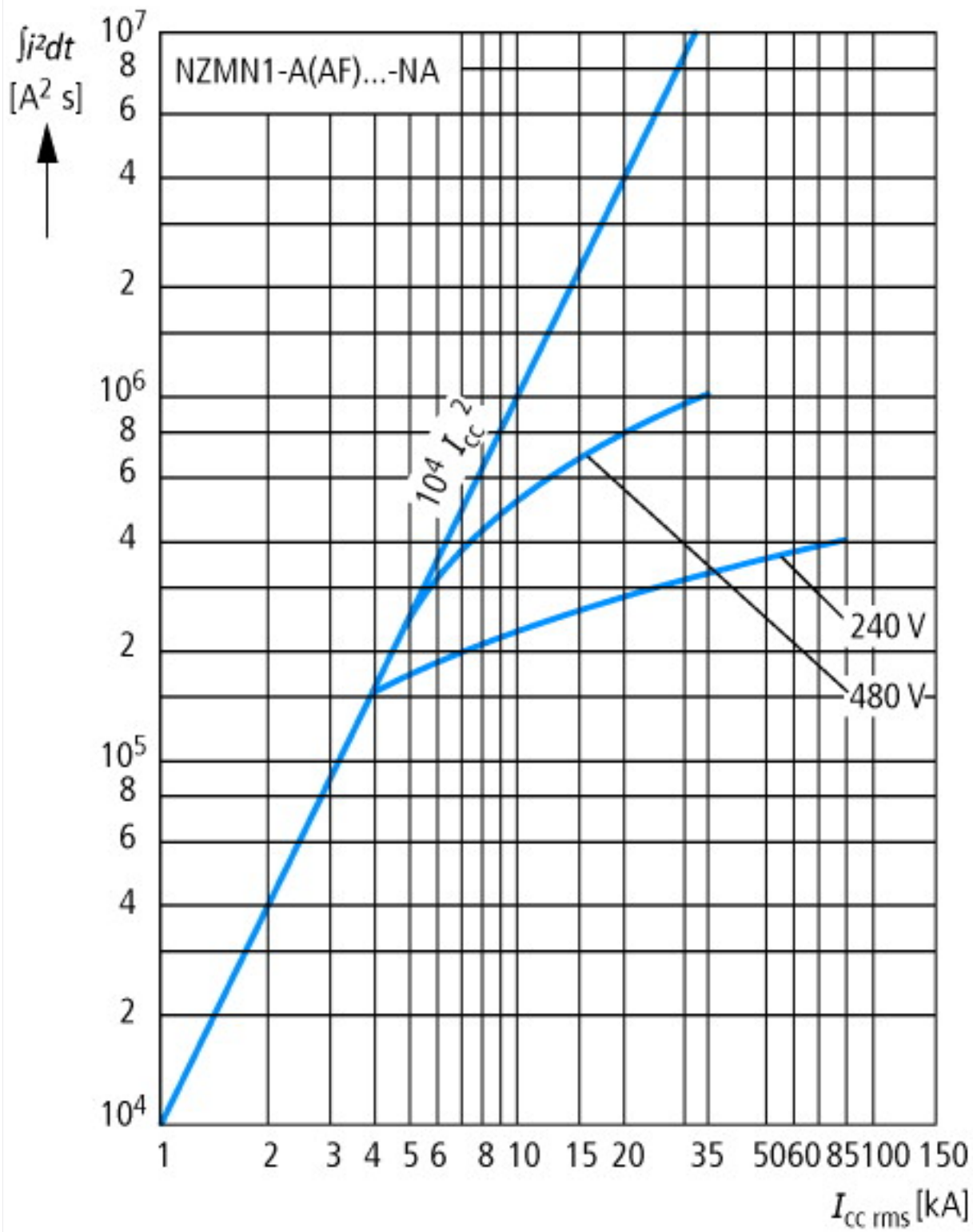

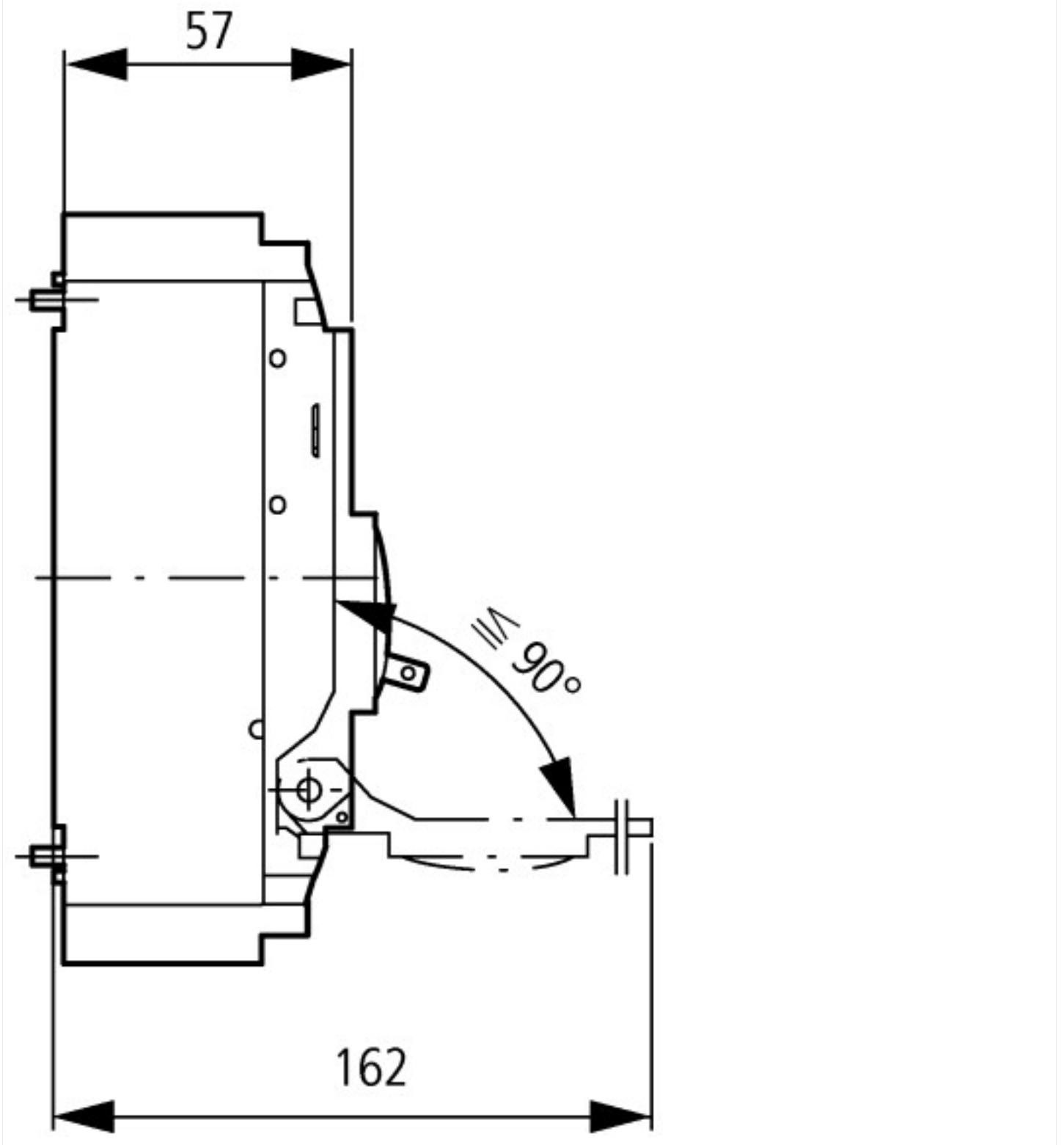

Additional product information (links)

IL01203004Z (AWA1230-1913) Circuit-breaker, Switch-Disconnecter

IL01203004Z (AWA1230-1913) Circuit-breaker, Switch-Disconnecter ftp://ftp.moeller.net/DOCUMENTATION/AWA_INSTRUCTIONS/IL01203004Z2015_11.pdf

Weight <http://ecat.moeller.net/flip-cat/?edition=HPLEN&startpage=17.171>

Temperature dependency, Derating <http://ecat.moeller.net/flip-cat/?edition=HPLEN&startpage=17.172>

Effective power loss <http://ecat.moeller.net/flip-cat/?edition=HPLEN&startpage=17.174>