





## Circuit-breaker, 3p, 90A, box terminals

Part no. **NZMH2-AF90-BT-NA**  
 Article no. **107820**

Similar to illustration

## Delivery program

Product range				Circuit-breaker
Protective function				System and cable protection
Standard/Approval				UL/CSA, IEC
Release system				Thermomagnetic release
Installation type				Fixed
Description				Switches conform to UL/CSA as well as the IEC regulations. IEC switching performance values are contained on the rating plate. Fixed overload releases Ir
Frame size				NZM2
Number of poles				3 pole
Standard equipment				Box terminal
<b>Switching capacity</b>				
SCCR 480Y/277 V 60 Hz	$I_{cu}$	kA		150
SCCR 480 V 60 Hz	$I_{cu}$	kA		150
SCCR 600Y/347 V 60 Hz	$I_{cu}$	kA		65
<b>Rated current = rated uninterrupted current</b>				
Rated current = rated uninterrupted current	$I_n = I_u$	A		90
<b>Setting range</b>				
Overload trip				
	$I_r$	A		90 - 90
Short-circuit releases				
				
Non-delayed	$I_i = I_n \times \dots$			Approx. 6 - 10
				

## Technical data

### General

Standards				IEC/EN 60947
Protection against direct contact				Finger and back of hand proof to VDE 0106 Part 100
Climatic proofing				Damp heat, constant, to IEC 60068-2-78 Damp heat, cyclic, to IEC 60068-2-30
Ambient temperature				
Ambient temperature, storage		°C		- 40 - + 70
Operation		°C		-25 - +70
Mechanical shock resistance (10 ms half-sinusoidal shock) according to IEC 60068-2-27		g		20 (half-sinusoidal shock 20 ms)
Safe isolation to EN 61140				
Between auxiliary contacts and main contacts		V AC		500
between the auxiliary contacts		V AC		300
Weight		kg		2.345
Mounting position				
Mounting position				Vertical and 90° in all directions



With residual-current release XFI:

- NZM1, N1, NZM2, N2: vertical and 90° in all directions

with plug-in adapter elements

- NZM1, N1, NZM2, N2: vertical, 90° right/left

with withdrawable unit:

- NZM3, N3: vertical, 90° left
- NZM4, N4: vertical

with remote operator:

- NZM2, N(S)2, NZM3, N(S)3, NZM4, N(S)4: vertical and 90° in all directions

Direction of incoming supply		as required
Degree of protection		
Device		In the operating controls area: IP20 (basic degree of protection)
Enclosures		With insulating surround: IP40 With door coupling rotary handle: IP66
Terminations		Tunnel terminal: IP10 Phase isolator and strip terminal: IP00
Other technical data (sheet catalogue)		Weight Temperature dependency, Derating Effective power loss

### Circuit-breakers

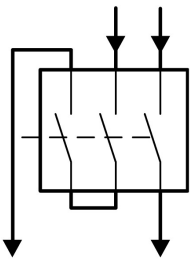
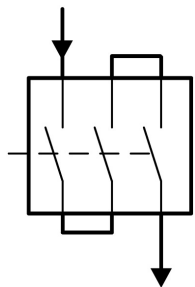
Rated surge voltage invariability	$U_{imp}$		
Main contacts		V	8000
Auxiliary contacts		V	6000
Rated operational voltage	$U_e$	V AC	690
Rated operational voltage	$U_e$	V DC	750
			<p>Details apply for 3 pole system protection circuit-breaker with thermomagnetic release NZMN(H)1(2)(3)-A... to 500 A.</p> <p>For rated operating voltage switching via 3 contacts:</p> <p>DC correction factor for instantaneous release response value: NZM1: 1.25, NZM2: 1.35, NZM3: 1.45</p> <p>Set value for <math>I_i</math> at DC = set value <math>I_i</math> AC/correction factor DC</p> <p><b>Switching of one pole via two series contacts</b></p>  <p><b>Switching of one pole via three series contacts</b></p> 
Overvoltage category/pollution degree			III/3
Rated insulation voltage	$U_i$	V	1000
Use in unearthed supply systems		V	≦ 690

### Switching capacity

Rated short-circuit making capacity	$I_{cm}$		
240 V	$I_{cm}$	kA	330
400/415 V	$I_{cm}$	kA	330
440 V 50/60 Hz	$I_{cm}$	kA	286
525 V 50/60 Hz	$I_{cm}$	kA	105
690 V 50/60 Hz	$I_c$	kA	40
Rated short-circuit breaking capacity $I_{cn}$	$I_{cn}$		
$I_{cu}$ to IEC/EN 60947 test cycle O-t-CO	$I_{cu}$	kA	
240 V 50/60 Hz	$I_{cu}$	kA	150
400/415 V 50/60 Hz	$I_{cu}$	kA	150
440 V 50/60 Hz	$I_{cu}$	kA	130

525 V 50/60 Hz	I <sub>cu</sub>	kA	50
690 V 50/60 Hz	I <sub>cu</sub>	kA	20
500 V DC	I <sub>cu</sub>	kA	60
750 V DC	I <sub>cu</sub>	kA	60
I <sub>cs</sub> to IEC/EN 60947 test cycle O-t-CO-t-CO	I <sub>cs</sub>	kA	
240 V 50/60 Hz	I <sub>cs</sub>	kA	150
400/415 V 50/60 Hz	I <sub>cs</sub>	kA	150
440 V 50/60 Hz	I <sub>cs</sub>	kA	130
525 V 50/60 Hz	I <sub>cs</sub>	kA	37.5
690 V 50/60 Hz	I <sub>cs</sub>	kA	5
Maximum low-voltage h.b.c. fuse		A gG/gL	355
			Maximum back-up fuse, if the expected short-circuit currents at the installation location exceed the switching capacity of the circuit-breaker.
<b>Technical data that diverge from products for the IEC market</b>			
Switching capacity of NA switches (UL489, CSA 22.2 No. 5.1)			
Short-circuit current rating SCCR			
SCCR 240 V 60 Hz	I <sub>cu</sub>	kA	150
SCCR 480Y/277 V 60 Hz	I <sub>cu</sub>	kA	150
SCCR 480 V 60 Hz	I <sub>cu</sub>	kA	150
SCCR 600Y/347 V 60 Hz	I <sub>cu</sub>	kA	65
Rated short-time withstand current			
t = 0.3 s	I <sub>cw</sub>	kA	1.9
t = 1 s	I <sub>cw</sub>	kA	1.9
Utilization category to IEC/EN 60947-2			
Rated making and breaking capacity			A
Rated operational current			
AC-1	I <sub>e</sub>	A	
400/415 V 50/60 Hz	I <sub>e</sub>	A	300
415 V	I <sub>e</sub>	A	300
690 V 50/60 Hz	I <sub>e</sub>	A	90
AC--3	I <sub>e</sub>	A	
400/415 V 50/60 Hz	I <sub>e</sub>	A	90
690 V 50/60 Hz	I <sub>e</sub>	A	90
DC-1	I <sub>e</sub>	CSA	
500 V DC	I <sub>e</sub>	CSA	90
750 V DC	I <sub>e</sub>	CSA	90
DC - 3	I <sub>e</sub>	CSA	
500 V DC	I <sub>e</sub>	CSA	90
750 V DC	I <sub>e</sub>	CSA	90
Lifespan, mechanical(of which max. 50 % trip by shunt/undervoltage release)	Operations		20000
Lifespan, electrical			
AC-1			
400 V 50/60 Hz	Operations		10000
690 V 50/60 Hz	Operations		7500
AC--3			
400 V 50/60 Hz	Operations		6500
415 V 50/60 Hz	Operations		6500
690 V 50/60 Hz	Operations		5000
DC-1			
500 V DC	Operations		3500
750 V DC	Operations		3500
DC - 3			
500 V DC	Operations		3000
750 V DC	Operations		3000

Max. operating frequency		Ops/h	120
Total downtime in a short-circuit		ms	< 10
<b>Terminal capacity</b>			
Standard equipment			Box terminal
Round copper conductor			
Box terminal			
Solid		mm <sup>2</sup>	1 x (12 ... 6)
Stranded		mm <sup>2</sup>	1 x (4 ... 350)
Tunnel terminal			
Solid		mm <sup>2</sup>	1 x 16
Stranded		mm <sup>2</sup>	
Stranded		mm <sup>2</sup>	1 x (4 ... 350)
Bolt terminal and rear-side connection			
Direct on the switch			
Solid		mm <sup>2</sup>	1 x (11 ... 6)
Stranded		mm <sup>2</sup>	1 x (4 ... 3/0)
Al conductors, Cu cable			
Solid		mm <sup>2</sup>	1 x 16
Bolt terminal and rear-side connection			
Flat copper strip, with holes	min.	mm	2 x 16 x 0.8
Flat copper strip, with holes	max.	mm	10 x 16 x 0.8
Cu strip (number of segments x width x segment thickness)			
Box terminal			
	min.	mm	2 x 9 x 0.8
	max.	mm	10 x 16 x 0.8
Bolt terminal and rear-side connection			
Flat copper strip, with holes	min.	mm	2 x 16 x 0.8
Flat copper strip, with holes	max.	mm	10 x 16 x 0.8
Copper busbar (width x thickness)		mm	
Bolt terminal and rear-side connection			
Screw connection			M8
Direct on the switch			
	min.	mm	16 x 5
	max.	mm	20 x 5
Control cables			
		mm <sup>2</sup>	1 x (18 ... 14) 2 x (18 ... 16)

## Design verification as per IEC/EN 61439

Technical data for design verification			
Rated operational current for specified heat dissipation	I <sub>n</sub>	A	90
Equipment heat dissipation, current-dependent	P <sub>vid</sub>	W	20.78
Operating ambient temperature min.		°C	-25
Operating ambient temperature max.		°C	70
IEC/EN 61439 design verification			
10.2 Strength of materials and parts			
10.2.2 Corrosion resistance			Meets the product standard's requirements.
10.2.3.1 Verification of thermal stability of enclosures			Meets the product standard's requirements.
10.2.3.2 Verification of resistance of insulating materials to normal heat			Meets the product standard's requirements.
10.2.3.3 Verification of resistance of insulating materials to abnormal heat and fire due to internal electric effects			Meets the product standard's requirements.
10.2.4 Resistance to ultra-violet (UV) radiation			Meets the product standard's requirements.
10.2.5 Lifting			Does not apply, since the entire switchgear needs to be evaluated.
10.2.6 Mechanical impact			Does not apply, since the entire switchgear needs to be evaluated.

10.2.7 Inscriptions			Meets the product standard's requirements.
10.3 Degree of protection of ASSEMBLIES			Does not apply, since the entire switchgear needs to be evaluated.
10.4 Clearances and creepage distances			Meets the product standard's requirements.
10.5 Protection against electric shock			Does not apply, since the entire switchgear needs to be evaluated.
10.6 Incorporation of switching devices and components			Does not apply, since the entire switchgear needs to be evaluated.
10.7 Internal electrical circuits and connections			Is the panel builder's responsibility.
10.8 Connections for external conductors			Is the panel builder's responsibility.
10.9 Insulation properties			
10.9.2 Power-frequency electric strength			Is the panel builder's responsibility.
10.9.3 Impulse withstand voltage			Is the panel builder's responsibility.
10.9.4 Testing of enclosures made of insulating material			Is the panel builder's responsibility.
10.10 Temperature rise			The panel builder is responsible for the temperature rise calculation. Eaton will provide heat dissipation data for the devices.
10.11 Short-circuit rating			Is the panel builder's responsibility. The specifications for the switchgear must be observed.
10.12 Electromagnetic compatibility			Is the panel builder's responsibility. The specifications for the switchgear must be observed.
10.13 Mechanical function			The device meets the requirements, provided the information in the instruction leaflet (IL) is observed.

## Approvals

Product Standards			UL 489; CSA-C22.2 No. 5-09; IEC 60947-2; CE marking
UL File No.			E31593
UL Category Control No.			DIVQ
CSA File No.			022086
CSA Class No.			1432-01
North America Certification			UL listed, CSA certified
Specially designed for North America			Yes
Suitable for			Feeder circuits, branch circuits
Current Limiting Circuit-Breaker			Yes
Max. Voltage Rating			600Y/347 V, 480 V
Degree of Protection			IEC: IP20; UL/CSA Type: -

# Characteristics

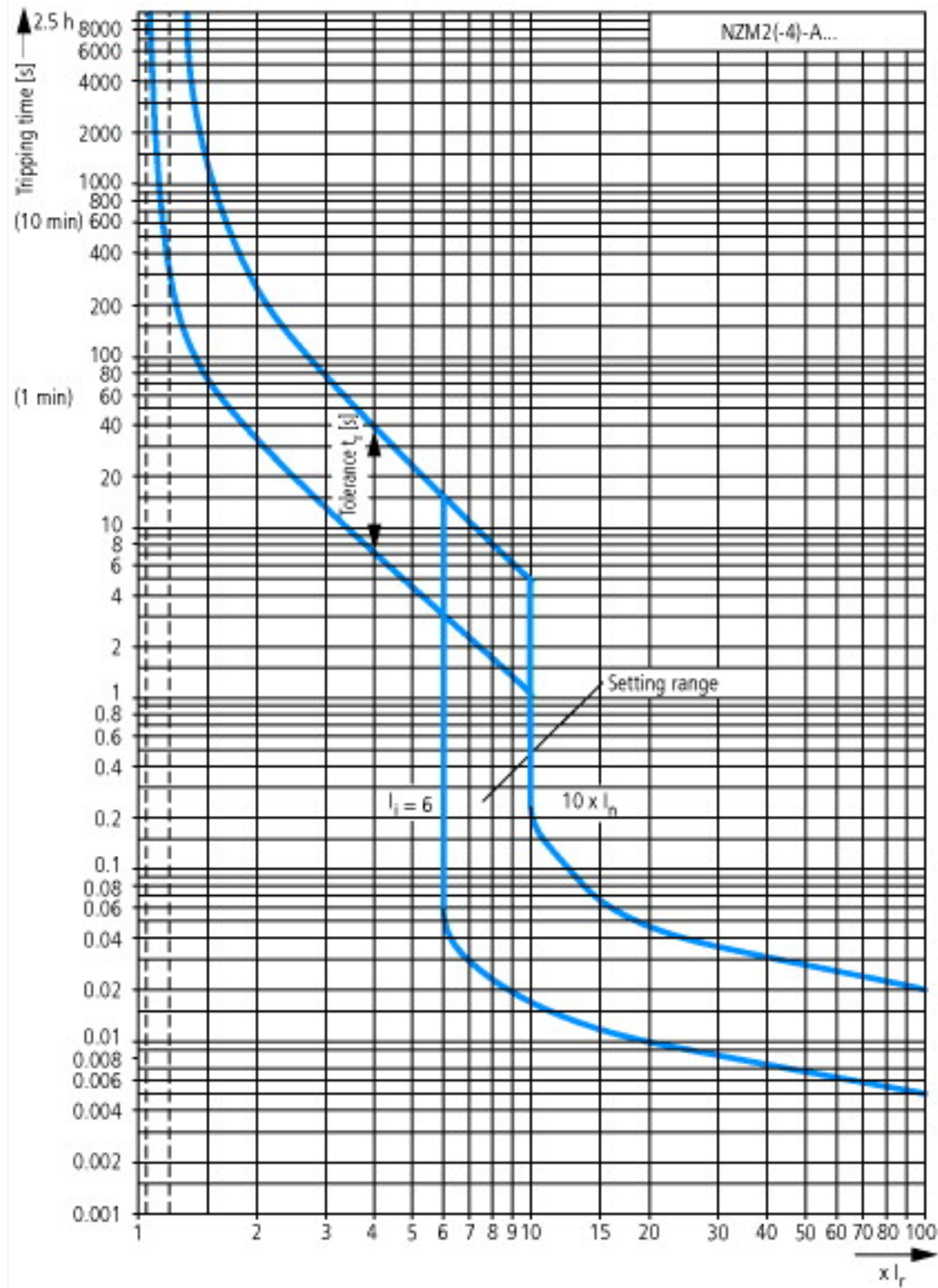

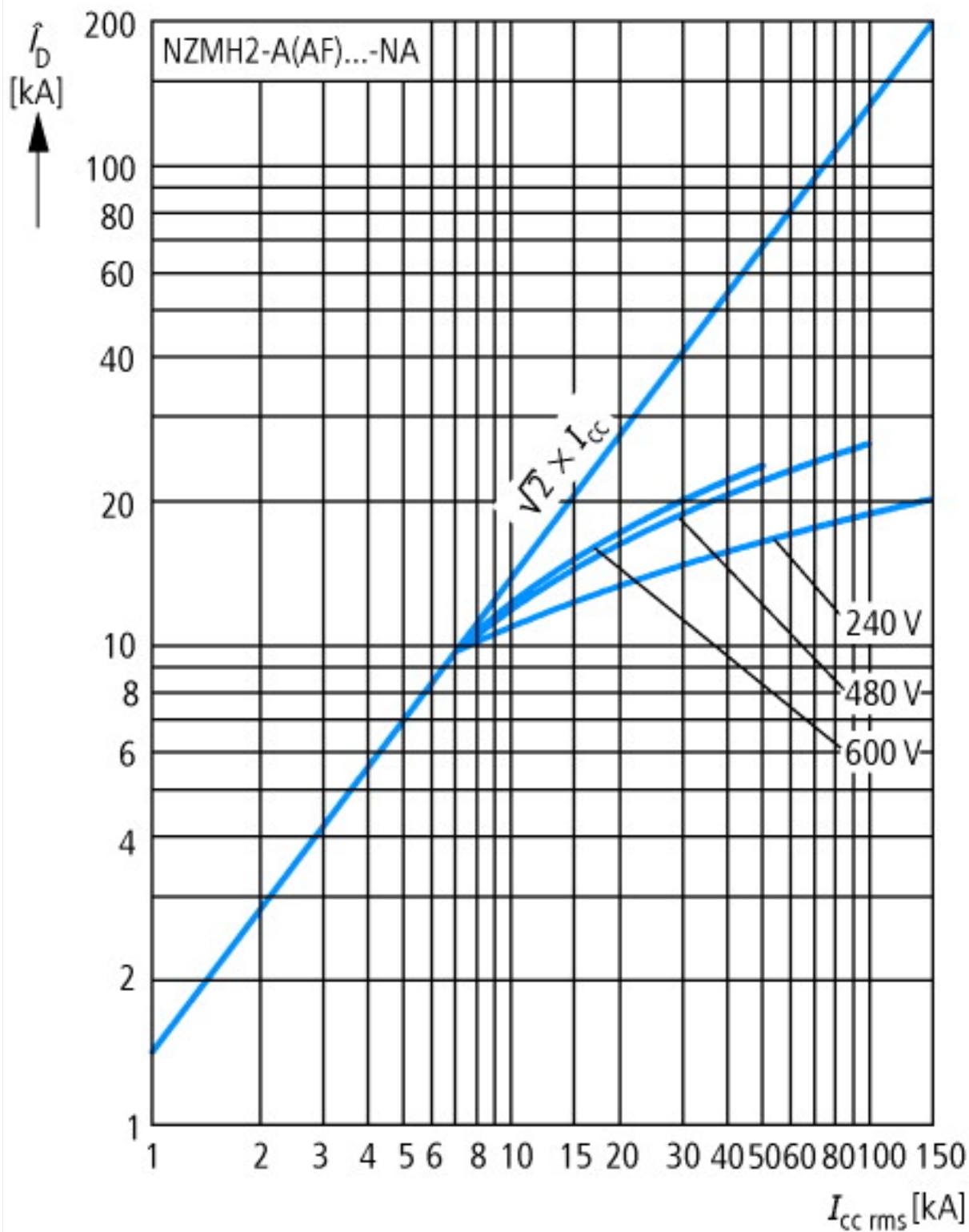

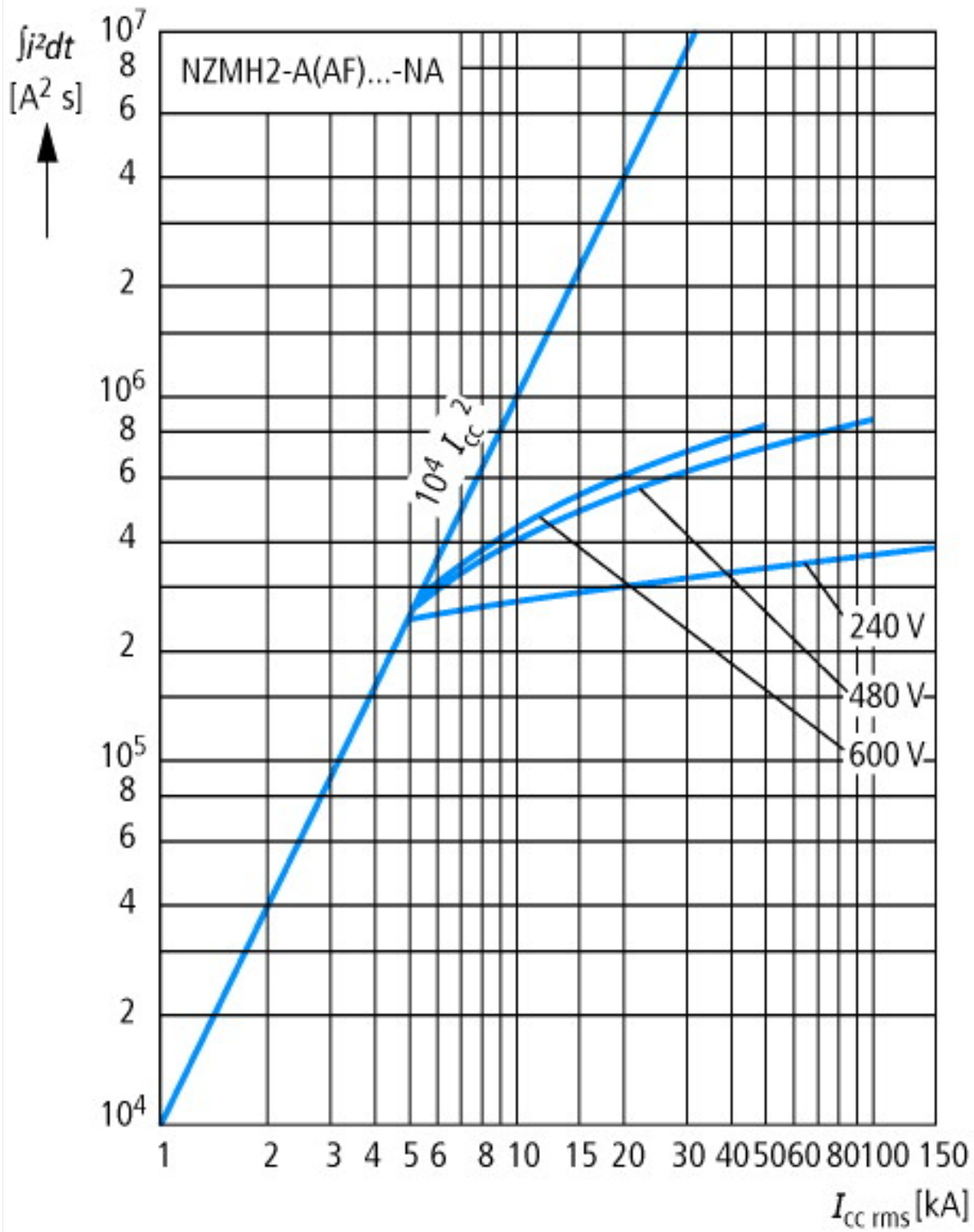



## Dimensions

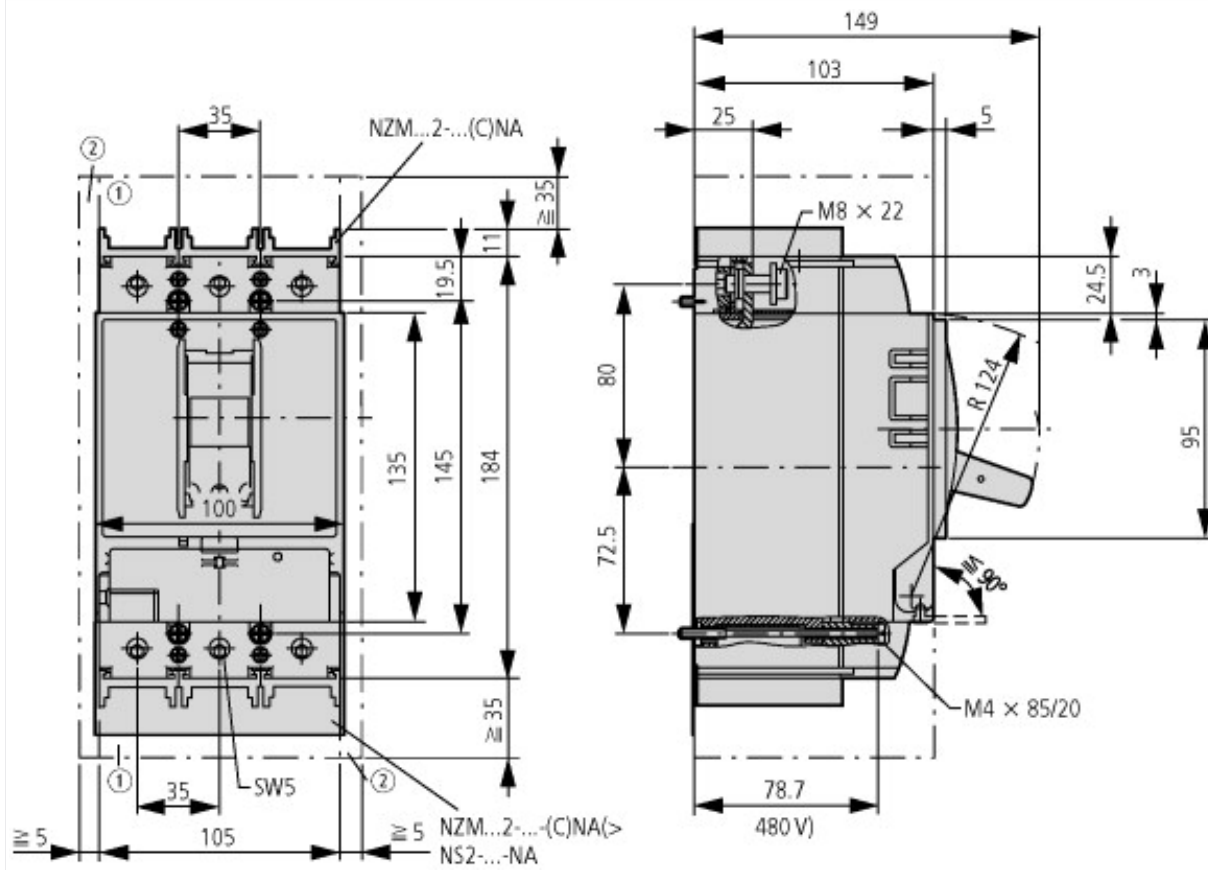

- ① Blow out area, minimum clearance to adjacent parts
- ② Minimum clearance to adjacent parts



### Additional product information (links)

#### IL01206006Z (AWA1230-1916) Circuit-Breaker, basic unit

IL01206006Z (AWA1230-1916) Circuit-Breaker, basic unit [ftp://ftp.moeller.net/DOCUMENTATION/AWA\\_INSTRUCTIONS/IL01206006Z2015\\_11.pdf](ftp://ftp.moeller.net/DOCUMENTATION/AWA_INSTRUCTIONS/IL01206006Z2015_11.pdf)

Weight <http://ecat.moeller.net/flip-cat/?edition=HPLEN&startpage=17.171>

Temperature dependency, Derating <http://ecat.moeller.net/flip-cat/?edition=HPLEN&startpage=17.172>

Effective power loss <http://ecat.moeller.net/flip-cat/?edition=HPLEN&startpage=17.174>