





## Circuit-breaker, 3p, 40A

**Part no.** NZMB1-S40-CNA  
**Article no.** 281263

Similar to illustration

## Delivery program

Product range			Circuit-breaker
Protective function			Short-circuit protection
Standard/Approval			UL/CSA, IEC
Installation type			Fixed
Release system			Thermomagnetic release
Description			Switches conform to UL/CSA as well as the IEC regulations. IEC switching performance values are contained on the rating plate. Motor protection in conjunction with contactor and overload relay With short-circuit release Without overload release Ir
Number of poles			3 pole
Standard equipment			Box terminal
Rated current = rated uninterrupted current	$I_n = I_u$	A	40
<b>Setting range</b>			
Short-circuit releases			
			
Non-delayed	$I_i = I_n \times \dots$		8 - 14
			

## Technical data

### General

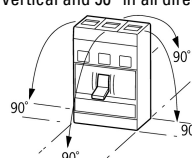
Standards			IEC/EN 60947
Protection against direct contact			Finger and back of hand proof to VDE 0106 Part 100
Climatic proofing			Damp heat, constant, to IEC 60068-2-78 Damp heat, cyclic, to IEC 60068-2-30
Ambient temperature			
Ambient temperature, storage		°C	- 40 - + 70
Operation		°C	-25 - +70
Mechanical shock resistance (10 ms half-sinusoidal shock) according to IEC 60068-2-27		g	20 (half-sinusoidal shock 20 ms)
Safe isolation to EN 61140			
Between auxiliary contacts and main contacts		V AC	500
between the auxiliary contacts		V AC	300
Mounting position			
Mounting position			Vertical and 90° in all directions  With residual-current release XFI: - NZM1, N1, NZM2, N2: vertical and 90° in all directions with plug-in adapter elements - NZM1, N1, NZM2, N2: vertical, 90° right/left with withdrawable unit: - NZM3, N3: vertical, 90° left - NZM4, N4: vertical with remote operator: - NZM2, N(S)2, NZM3, N(S)3, NZM4, N(S)4: vertical and 90° in all directions
Direction of incoming supply			as required
Degree of protection			

Device			In the operating controls area: IP20 (basic degree of protection)
Enclosures			With insulating surround: IP40 With door coupling rotary handle: IP66
Terminations			Tunnel terminal: IP10 Phase isolator and strip terminal: IP00
Other technical data (sheet catalogue)			Weight Temperature dependency, Derating Effective power loss

### Circuit-breakers

Rated surge voltage invariability	$U_{imp}$		
Main contacts		V	6000
Auxiliary contacts		V	6000
Rated operational voltage	$U_e$	V AC	440
Overvoltage category/pollution degree			III/3
Rated insulation voltage	$U_i$	V	690
Use in unearthed supply systems		V	 440

### Switching capacity

Rated short-circuit making capacity	$I_{cm}$		
240 V	$I_{cm}$	kA	63
400/415 V	$I_{cm}$	kA	53
440 V 50/60 Hz	$I_{cm}$	kA	53
Rated short-circuit breaking capacity $I_{cn}$	$I_{cn}$		
Icu to IEC/EN 60947 test cycle O-t-CO	$I_{cu}$	kA	
240 V 50/60 Hz	$I_{cu}$	kA	30
400/415 V 50/60 Hz	$I_{cu}$	kA	25
440 V 50/60 Hz	$I_{cu}$	kA	25
Ics to IEC/EN 60947 test cycle O-t-CO-t-CO	$I_{cs}$	kA	
240 V 50/60 Hz	$I_{cs}$	kA	30
400/415 V 50/60 Hz	$I_{cs}$	kA	25
440 V 50/60 Hz	$I_{cs}$	kA	18.5
Maximum low-voltage h.b.c. fuse		A gG/gL	200
			Maximum back-up fuse, if the expected short-circuit currents at the installation location exceed the switching capacity of the circuit-breaker.
Utilization category to IEC/EN 60947-2			A
Rated making and breaking capacity			
Rated operational current	$I_e$	A	
AC-1			
400/415 V 50/60 Hz	$I_e$	A	160
415 V	$I_e$	A	125
AC--3			
400/415 V 50/60 Hz	$I_e$	A	160
Lifespan, mechanical(of which max. 50 % trip by shunt/undervoltage release)	Operations		20000
Lifespan, electrical			
AC--3			
415 V 50/60 Hz	Operations		7500
Max. operating frequency		Ops/h	120
Total downtime in a short-circuit		ms	< 10

### Terminal capacity

Standard equipment			Box terminal
Round copper conductor			
Box terminal			
Solid		mm <sup>2</sup>	1 x (12 ... 6)
Stranded		mm <sup>2</sup>	1 x (4 ... 2/0)
Tunnel terminal			
Solid		mm <sup>2</sup>	1 x 6

Stranded		mm <sup>2</sup>	
Stranded		mm <sup>2</sup>	1 x (4 ... 3/0)
Bolt terminal and rear-side connection			
Direct on the switch			
Solid		mm <sup>2</sup>	1 x (12 ... 6) 2 x (9 ... 6)
Stranded		mm <sup>2</sup>	1 x (4 ... 2/0)
Al conductors, Cu cable			
Solid		mm <sup>2</sup>	1 x 16
Cu strip (number of segments x width x segment thickness)			
Box terminal			
	min.	mm	2 x 9 x 0.8
	max.	mm	9 x 9 x 0.8
Copper busbar (width x thickness)		mm	
Bolt terminal and rear-side connection			
Screw connection			M6
Direct on the switch			
	min.	mm	12 x 5
	max.	mm	16 x 5
Control cables			
		mm <sup>2</sup>	1 x (18 ... 14) 2 x (18 ... 16)

## Design verification as per IEC/EN 61439

Technical data for design verification			
Rated operational current for specified heat dissipation	I <sub>n</sub>	A	40
Equipment heat dissipation, current-dependent	P <sub>vid</sub>	W	2.7
Operating ambient temperature min.		°C	-25
Operating ambient temperature max.		°C	70
IEC/EN 61439 design verification			
10.2 Strength of materials and parts			
10.2.2 Corrosion resistance			Meets the product standard's requirements.
10.2.3.1 Verification of thermal stability of enclosures			Meets the product standard's requirements.
10.2.3.2 Verification of resistance of insulating materials to normal heat			Meets the product standard's requirements.
10.2.3.3 Verification of resistance of insulating materials to abnormal heat and fire due to internal electric effects			Meets the product standard's requirements.
10.2.4 Resistance to ultra-violet (UV) radiation			Meets the product standard's requirements.
10.2.5 Lifting			Does not apply, since the entire switchgear needs to be evaluated.
10.2.6 Mechanical impact			Does not apply, since the entire switchgear needs to be evaluated.
10.2.7 Inscriptions			Meets the product standard's requirements.
10.3 Degree of protection of ASSEMBLIES			Does not apply, since the entire switchgear needs to be evaluated.
10.4 Clearances and creepage distances			Meets the product standard's requirements.
10.5 Protection against electric shock			Does not apply, since the entire switchgear needs to be evaluated.
10.6 Incorporation of switching devices and components			Does not apply, since the entire switchgear needs to be evaluated.
10.7 Internal electrical circuits and connections			Is the panel builder's responsibility.
10.8 Connections for external conductors			Is the panel builder's responsibility.
10.9 Insulation properties			
10.9.2 Power-frequency electric strength			Is the panel builder's responsibility.
10.9.3 Impulse withstand voltage			Is the panel builder's responsibility.
10.9.4 Testing of enclosures made of insulating material			Is the panel builder's responsibility.
10.10 Temperature rise			The panel builder is responsible for the temperature rise calculation. Eaton will provide heat dissipation data for the devices.
10.11 Short-circuit rating			Is the panel builder's responsibility. The specifications for the switchgear must be observed.
10.12 Electromagnetic compatibility			Is the panel builder's responsibility. The specifications for the switchgear must be observed.

## Technical data ETIM 6.0

Low-voltage industrial components (EG000017) / Motor protection circuit-breaker (EC000074)

Electric engineering, automation, process control engineering / Low-voltage switch technology / Circuit breaker (LV < 1 kV) / Motor protection circuit-breaker (ecl@ss8.1-27-37-04-01 [AGZ529013])

Overload release current setting	A	0 - 0
Adjustment range undelayed short-circuit release	A	320 - 560
Thermal protection		No
Phase failure sensitive		No
Switch off technique		Magnetic
Rated operating voltage	V	440 - 440
Rated permanent current I <sub>u</sub>	A	40
Rated operation power at AC-3, 230 V	kW	11
Rated operation power at AC-3, 400 V	kW	18.5
Type of electrical connection of main circuit		-
Type of control element		Rocker lever
Device construction		Built-in device fixed built-in technique
With integrated auxiliary switch		No
With integrated under voltage release		No
Number of poles		3
Rated short-circuit breaking capacity I <sub>cu</sub> at 400 V, AC	kA	25
Degree of protection (IP)		IP20
Height	mm	165.5
Width	mm	90
Depth	mm	88

## Approvals

Product Standards		UL 489; CSA-C22.2 No. 5-09; IEC 60947-2; CE marking
UL File No.		E31593
UL Category Control No.		DKPU2
CSA File No.		022086
CSA Class No.		1432-01
North America Certification		UL recognized, CSA certified
Conditions of Acceptability		Only used in motor circuits in conjunction with suitable contactor and overload relay. SCCR value applies for complete combination starter only, consisting of instantaneous trip circuit breaker, contactor and overload relay.
Specially designed for North America		Yes
Suitable for		Branch circuits, feeder circuits
Current Limiting Circuit-Breaker		No
Max. Voltage Rating		480Y/277 V
Degree of Protection		IEC: IP20; UL/CSA Type: -

## Characteristics

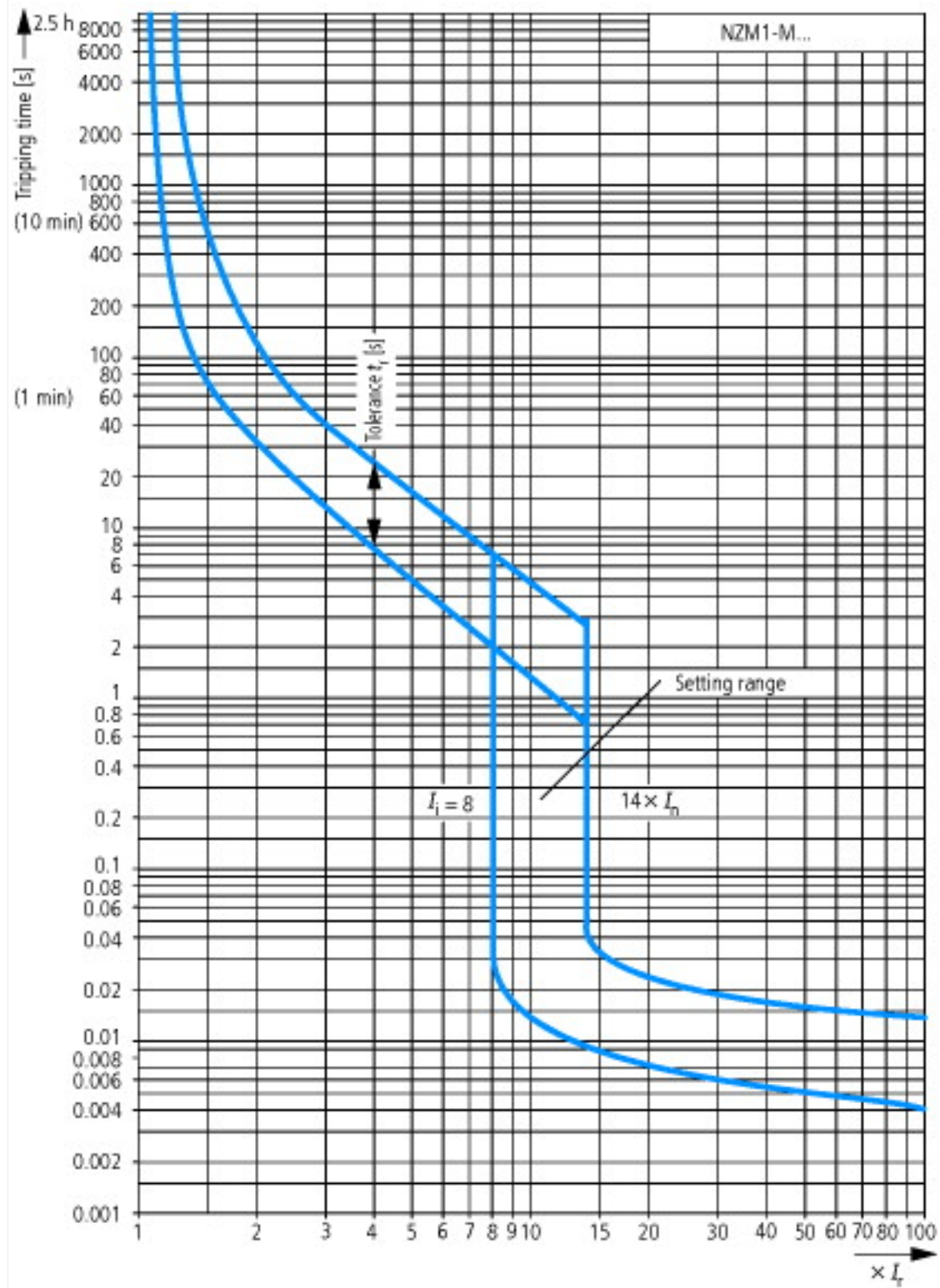

Short-circuit protection only!

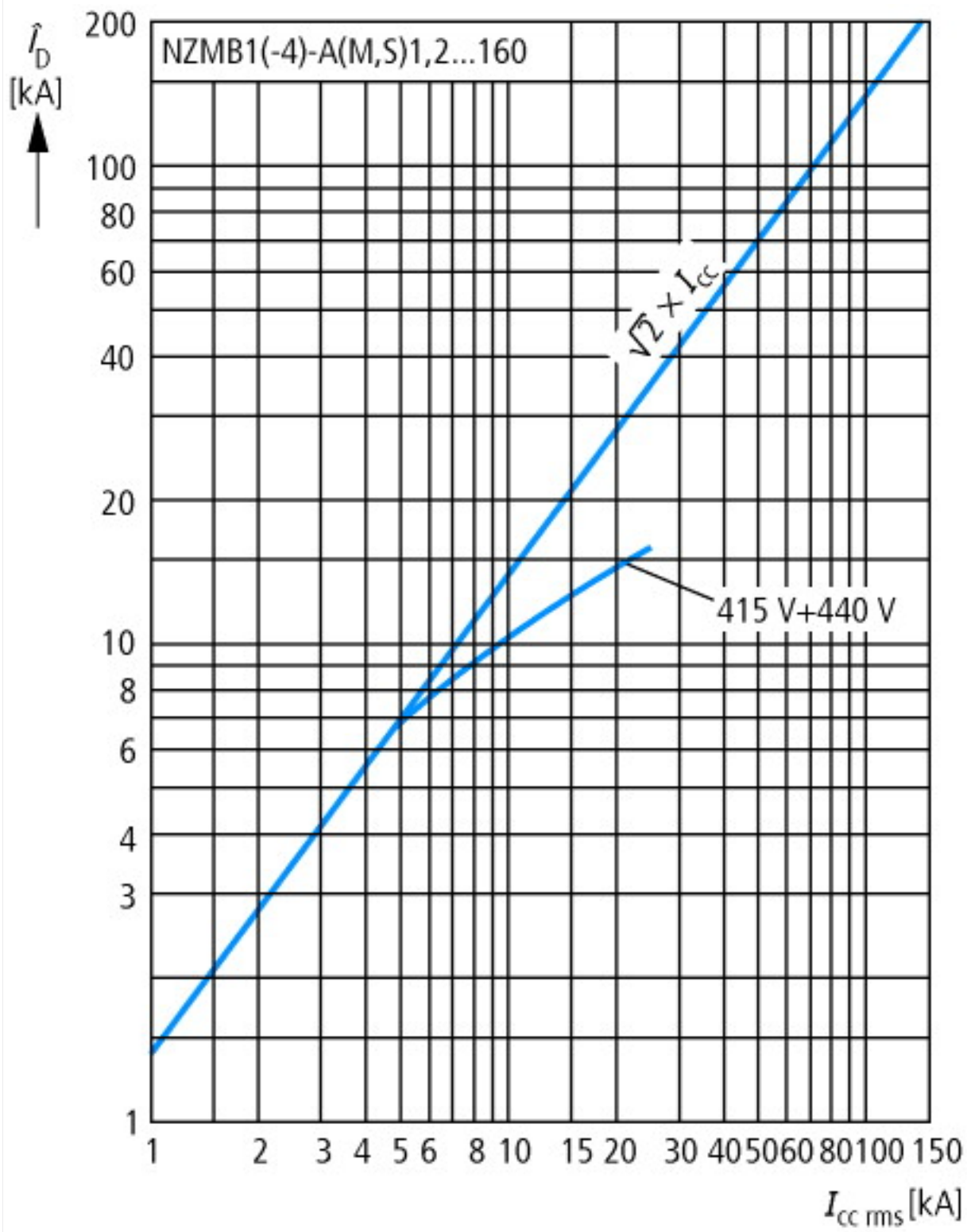

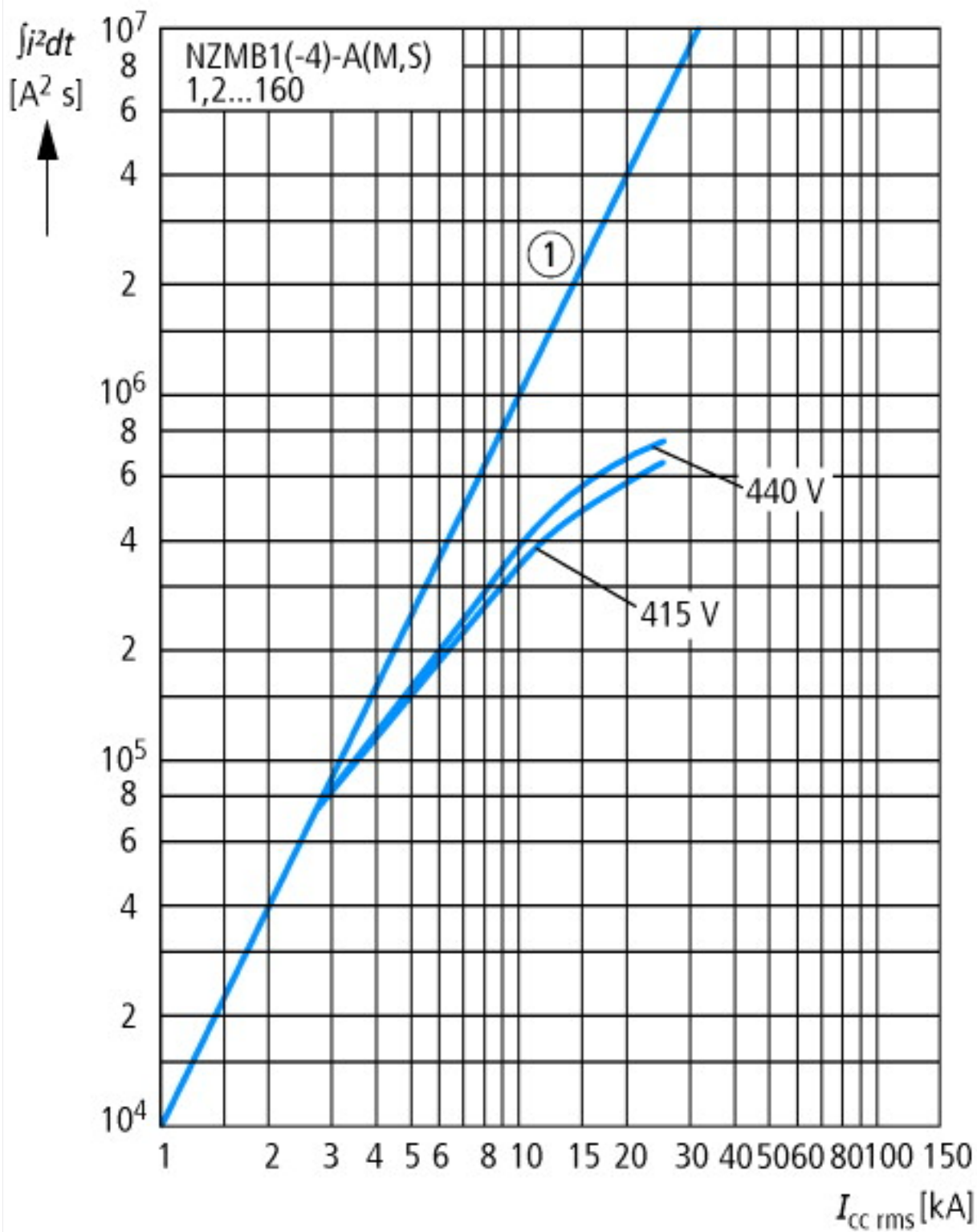

## Dimensions

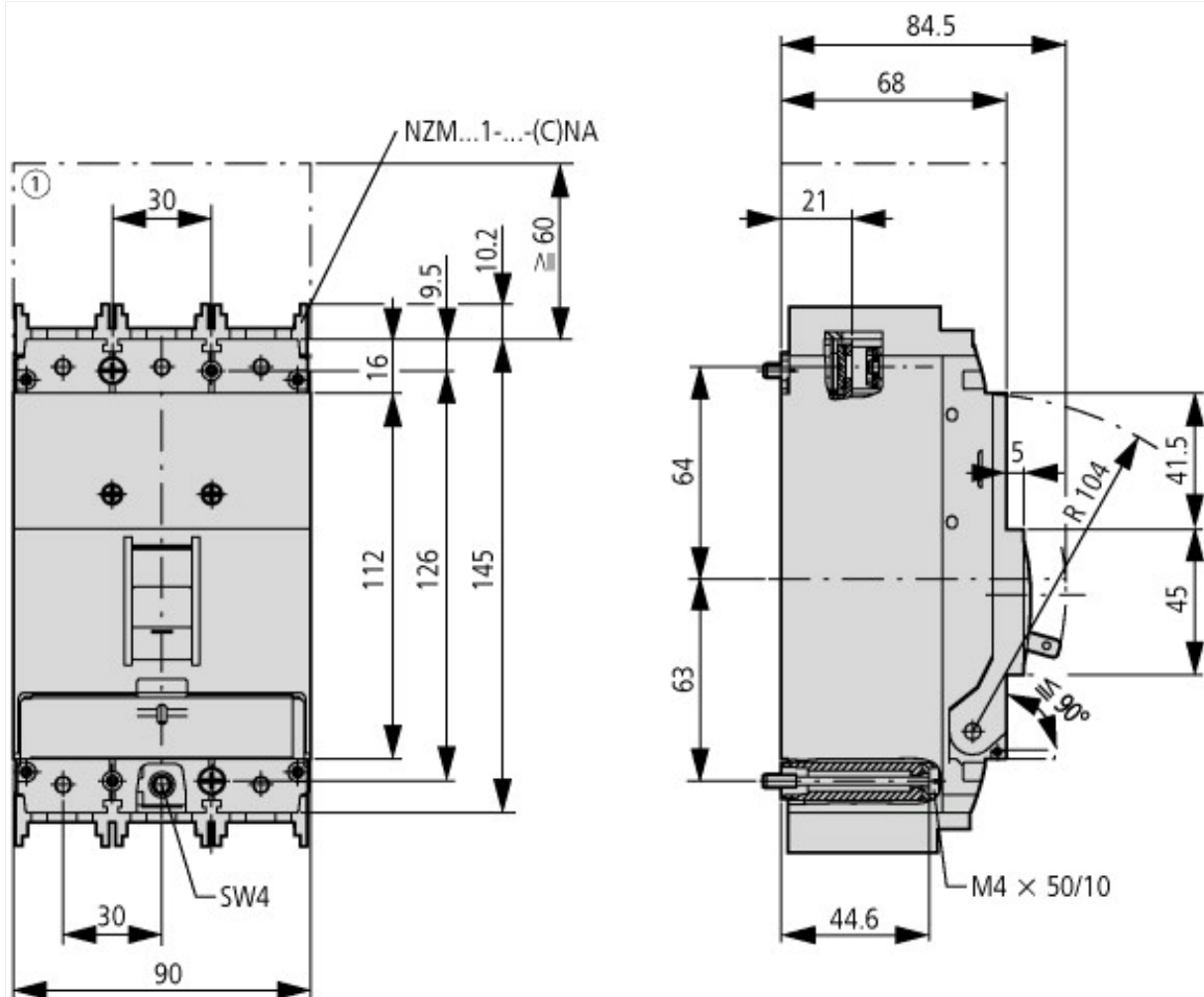





### Additional product information (links)

#### IL01203004Z (AWA1230-1913) Circuit-breaker, Switch-Disconnecter

IL01203004Z (AWA1230-1913) Circuit-breaker, Switch-Disconnecter [ftp://ftp.moeller.net/DOCUMENTATION/AWA\\_INSTRUCTIONS/IL01203004Z2015\\_11.pdf](ftp://ftp.moeller.net/DOCUMENTATION/AWA_INSTRUCTIONS/IL01203004Z2015_11.pdf)

Weight <http://ecat.moeller.net/flip-cat/?edition=HPLEN&startpage=17.171>

Temperature dependency, Derating <http://ecat.moeller.net/flip-cat/?edition=HPLEN&startpage=17.172>

Effective power loss <http://ecat.moeller.net/flip-cat/?edition=HPLEN&startpage=17.174>