

Part no. **IZM32H4-A12W**  
 Article no. **123836**

## Delivery program

Product range			Air circuit-breakers/switch-disconnectors
Product range			Open circuit-breakers
Current Range			4000 to 6300 A
Protective function			System protection
Installation type			Withdrawable
Construction size			IZM32
Standard/Approval			IEC
Number of poles			4 pole
Degree of Protection			IP20, IP55 with protective cover, IP41 with door sealing frame
Rated current = rated uninterrupted current	$I_n = I_u$	A	1250
Bemessungsgrenzkurzschlussausschaltvermögen bis 440V/690V 42/42	$I_{cu}$	kA	100
Bemessungsbetriebskurzschlussausschaltvermögen bis 440V/690V 42/42	$I_{cs}$	kA	100
Overload release, min.	$I_r$	A	500
Overload release, max.	$I_r$	A	1250
Non-delayed	$I_l = I_n \times \dots$		2 - 10



### Notes

Including rear connection main terminals and secondary terminal blocks according to ordered breaker options.

Note concerning the product

Cassette needs to be ordered separately.

## Technical data

### General

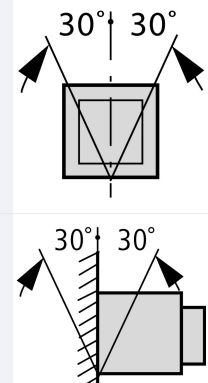
Standards			IEC/EN 60947
Ambient temperature			
Storage	θ	°C	-25 - +70 (device with LCD-display -20 - +70)
Operating (open)		°C	-25 - +70 (device with LCD-display -20 - +70)
Mounting position			
Utilization category			B
Degree of Protection			IP20, IP55 with protective cover, IP41 with door sealing frame
Direction of incoming supply			as required

### Main conducting paths

Rated current = rated uninterrupted current	$I_n = I_u$	A	1250
Rated uninterrupted current at 50 °C	$I_u$	A	1250
Rated uninterrupted current at 60 °C	$I_u$	A	1250
Rated uninterrupted current at 70 °C	$I_u$	A	1250
Rated impulse withstand voltage	$U_{imp}$	V AC	8000
Rated operational voltage	$U_e$	V AC	690

Use in IT electrical power networks up to U = 440 V	I <sub>IT</sub>	kA	13
Overvoltage category/pollution degree			III/3
Rated insulation voltage	U <sub>i</sub>	V	1000

### Switching capacity

Rated short-circuit making capacity	I <sub>cm</sub>		
up to 440 V 50/60 Hz	I <sub>cm</sub>	kA	210
up to 690 V 50/60 Hz	I <sub>cm</sub>	kA	179
Rated short-time withstand current 50/60 Hz			
t = 1 s	I <sub>cw</sub>	kA	85
t = 3 s	I <sub>cw</sub>	kA	65
Rated short-circuit breaking capacity I <sub>cn</sub>	I <sub>cn</sub>		
IEC/EN 60947 operating sequence I <sub>cu</sub> 0-t-CO			
up to 240 V 50/60 Hz	I <sub>cu</sub>	kA	100
up to 440 V 50/60 Hz	I <sub>cu</sub>	kA	100
up to 690 V 50/60 Hz	I <sub>cu</sub>	kA	85
IEC/EN 60947 operating sequence I <sub>cs</sub> 0-t-CO-t-CO			
up to 240 V 50/60 Hz	I <sub>cs</sub>	kA	100
up to 440 V 50/60 Hz	I <sub>cs</sub>	kA	100
up to 690 V 50/60 Hz	I <sub>cs</sub>	kA	85
Operating times			
Closing delay via spring release		ms	30
Break times		ms	40
Total opening delay via shunt release		ms	35
Total opening delay via undervoltage release		ms	35/70
Total opening delay on non-delayed short-circuit release (up to complete arc quenching)		ms	35
Maximum operating frequency	Operations/h		60
Heat dissipation at rated current I <sub>n</sub>			
Fixed mounting		W	70
Withdrawable units (switch with cassette)		W	140

### Weight

Fixed mounting			
3-pole		kg	68
4-pole		kg	86
Withdrawable			
3-pole		kg	80
4-pole		kg	102
Cassette			
3 pole		kg	34
4 pole		kg	38

### Terminal capacities

Copper bar			
Fixed mounting			
Black		mm	2 x 5 x 80
Withdrawable units			
Black		mm	2 x 5 x 80
			Permissible continuous current for circuit-breakers operating in switchboards at various internal ambient temperatures. The switchboard's internal ambient temperature should be estimated using the calculation methods of IEC regulation.
Other technical data (sheet catalogue)			Tripping characteristics for selective protection Notes - tripping characteristics

### Design verification as per IEC/EN 61439

Technical data for design verification			
Operating ambient temperature min.		°C	-25
Operating ambient temperature max.		°C	70

## Dimensions

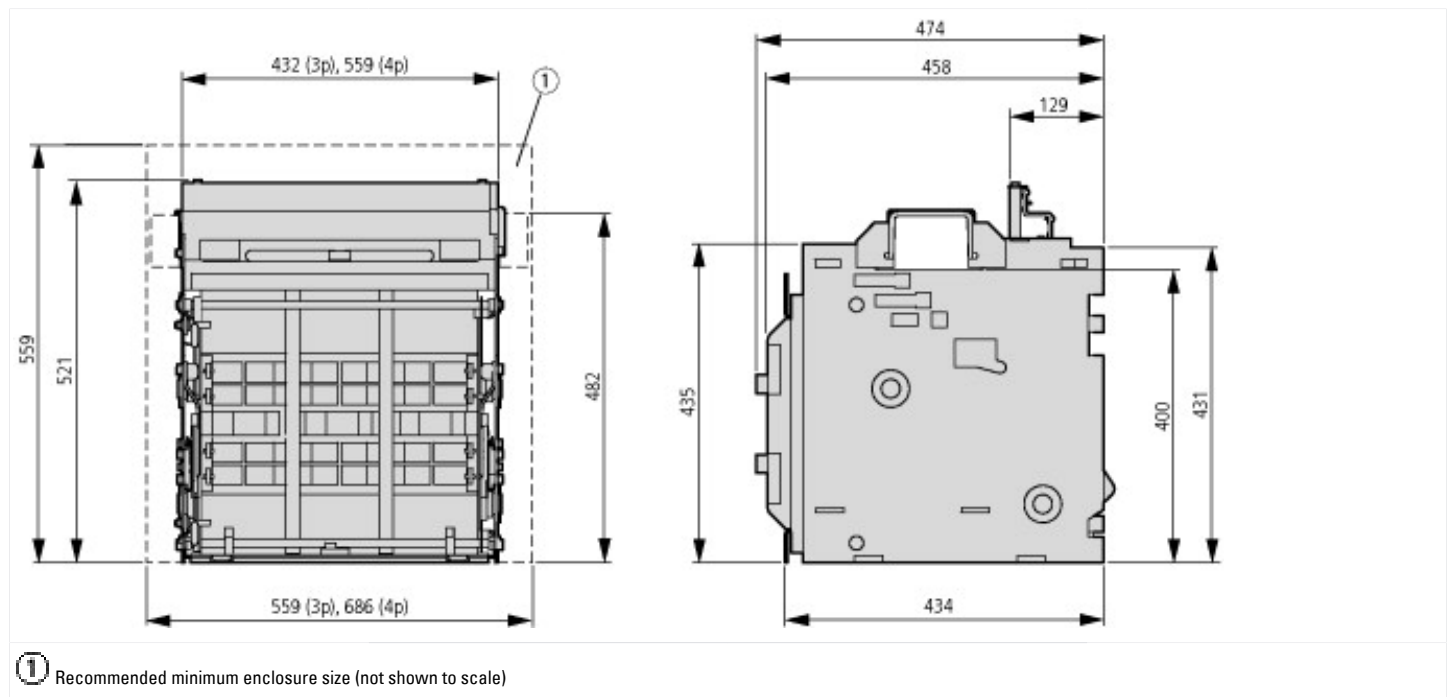

## Additional product information (links)

Tripping characteristics for selective protection	<a href="http://ecat.moeller.net/flip-cat/?edition=HPLEN&amp;startpage=18.78">http://ecat.moeller.net/flip-cat/?edition=HPLEN&amp;startpage=18.78</a>
Notes - tripping characteristics	<a href="http://ecat.moeller.net/flip-cat/?edition=HPLEN&amp;startpage=18.88">http://ecat.moeller.net/flip-cat/?edition=HPLEN&amp;startpage=18.88</a>