

Part no. **IN32N3-20W**
 Article no. **123685**

Delivery program

Product range			Air circuit-breakers/switch-disconnectors
Product range			Open switch-disconnectors
Current Range			4000 to 6300 A
Protective function			without protection
Installation type			Withdrawable
Construction size			IN32
Standard/Approval			IEC
Number of poles			3 pole
Degree of Protection			IP20, IP55 with protective cover
Rated current = rated uninterrupted current	$I_n = I_u$	A	2000
up to 440 V 50/60 Hz	I_{cm}	kA	69
t = 1 s	I_{cw}	kA	85
t = 3 s	I_{cw}	kA	65

Notes

Including rear connection main terminals and secondary terminal blocks according to ordered breaker options.

Note concerning the product

Cassette needs to be ordered separately.

Technical data

General

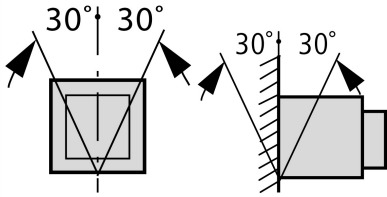
Standards			IEC/EN 60947
Ambient temperature			
Storage	θ	°C	-40 - +70
Operating (open)		°C	-25 - +70
Mounting position			
Utilization category			B
Degree of Protection			IP20, IP55 with protective cover
Direction of incoming supply			as required

Main conducting paths

Rated current = rated uninterrupted current	$I_n = I_u$	A	2000
Rated uninterrupted current at 50 °C	I_u	A	2000
Rated uninterrupted current at 60 °C	I_u	A	2000
Rated uninterrupted current at 70 °C	I_u	A	2000
Rated impulse withstand voltage	U_{imp}	V AC	8000
Rated operational voltage	U_e	V AC	690
Use in IT electrical power networks up to U = 440 V	I_{IT}	kA	28
Overvoltage category/pollution degree			III/3
Rated insulation voltage	U_i	V	1000

Switching capacity

Rated short-circuit making capacity	I_{cm}		
up to 440 V 50/60 Hz	I_{cm}	kA	69
up to 690 V 50/60 Hz	I_{cm}	kA	187
Rated short-time withstand current 50/60 Hz			

t = 1 s	I _{cw}	kA	85
t = 3 s	I _{cw}	kA	65
Operating times			
Closing delay via spring release		ms	35
Break times		ms	40
Total opening delay via shunt release		ms	30
Total opening delay via undervoltage release		ms	35/70
Maximum operating frequency			
Maximum operating frequency	Operations/h		60
Heat dissipation at rated current I_n			
Fixed mounting		W	190
Withdrawable units (switch with cassette)		W	380

Weight

Fixed mounting			
3-pole		kg	68
4-pole		kg	86
Withdrawable			
3-pole		kg	80
4-pole		kg	102
Cassette			
3 pole		kg	58
4 pole		kg	60

Terminal capacities

Copper bar			
Fixed mounting			
Black		mm	3 x 5 x 100
Withdrawable units			
Black		mm	3 x 5 x 100
Permissible continuous current for circuit-breakers operating in switchboards at various internal ambient temperatures. The switchboard's internal ambient temperature should be estimated using the calculation methods of IEC regulation.			

Design verification as per IEC/EN 61439

Technical data for design verification			
Operating ambient temperature min.		°C	-25
Operating ambient temperature max.		°C	70

Dimensions

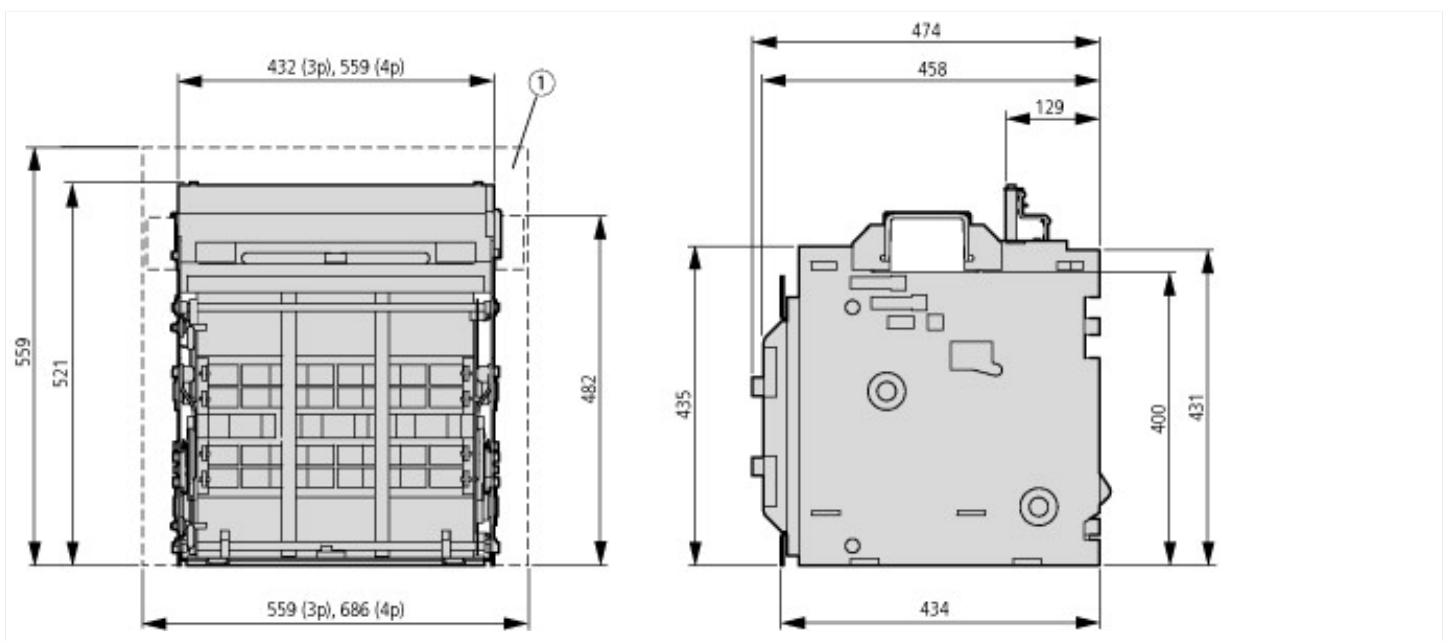

① Recommended minimum enclosure size (not shown to scale)

