



## Residual current circuit-breaker, 40A, 4p, 5A, A-Char

**Part no.** FI-40/4/05-A  
**Article no.** 279220  
**Catalog No.** FI-40-4-05-A

Similar to illustration

### Delivery program

Basic function			Residual current circuit breakers
Number of poles			4 pole
Rated current	$I_n$	A	40
Rated short-circuit strength	$I_{cn}$	kA	10
Rated fault current	$I_{\Delta N}$	A	0.5
Type			Type A
Tripping		A	non-delayed
Product range			FI
Sensitivity			AC and pulsating DC current sensitive
Impulse withstand current			Partly surge-proof 250 A

### Technical data

#### Electrical

Standards			IEC/EN 61008
Tripping		A	non-delayed
Rated operating voltage	$U_e$	V AC	230/400
Limit values of the operating voltage		V AC	184 ... 440
Rated frequency	$f$	Hz	50
Rated fault currents	$I_{\Delta n}$	mA	30, 100, 300, 500
Rated non-tripping current	$I_{\Delta no}$		$0.5 \times I_{\Delta n}$
Rated fault switching capacity			
Rated fault switching capacity	$I_{\Delta m}$	A	$I_n = 16 \dots 40$ A: 500 $I_n = 63$ A: 630 $I_n = 80$ A: 800 $I_n = 100$ A: 1000
Sensitivity			DC and pulsed current
Rated switching capacity	$I_{cn}$	kA	10
Rated current	$I_e$	A	40
Rated impulse withstand voltage	$U_{imp}$	kV	6
Maximum max. as short-circuit protective device		A gL	$I_n = 16 - 63$ A: 63 $I_n = 80$ A: 80 $I_n = 100$ A: 100
Lifespan		S	
Electrical			Operations > 4000
Mechanical			Operations > 20000

#### Mechanical

Standard front dimension		mm	45
Enclosure height		mm	80
Terminal protection			Protection against electric shock to IEC 536
Mounting width		mm	35 (2 space unit), 70 (4 space units)
Mounting			Top-hat rail IEC/EN 60715
Degree of protection			
Integrated			IP40
Terminals top and bottom			Twin-purpose terminals
Terminal capacities		mm <sup>2</sup>	
Solid		mm <sup>2</sup>	1.5 ... 35
flexible		mm <sup>2</sup>	2 x 16

Thickness of busbar material	mm	0.8 ... 2
Admissible ambient temperature range	°C	-25 ... +40
Climatic proofing		IEC/EN 61008

## Design verification as per IEC/EN 61439

Technical data for design verification			
Rated operational current for specified heat dissipation	$I_n$	A	40
Heat dissipation per pole, current-dependent	$P_{vid}$	W	0
Equipment heat dissipation, current-dependent	$P_{vid}$	W	8.4
Static heat dissipation, non-current-dependent	$P_{vs}$	W	0
Heat dissipation capacity	$P_{diss}$	W	0
Operating ambient temperature min.		°C	-25
Operating ambient temperature max.		°C	55
			Starting at 40 °C, the max. permissible continuous current decreases by 3% for every 1 °C

## Technical data ETIM 6.0

Circuit breakers and fuses (EG000020) / Residual current circuit breaker (RCCB) (EC000003)

Electric engineering, automation, process control engineering / Electrical installation, device / Residual current protection system / Residual current circuit breaker (RCCB) (ecI@ss8.1-27-14-22-01 [AAB906011])

Number of poles			4
Nominal rated voltage		V	400
Nominal rated current		A	40
Rated fault current		A	0.5
Mounting method			DIN rail
Leakage current type			A
Selective protection			No
Short-circuit breaking capacity ( $I_{cw}$ )		kA	10
Surge current capacity		kA	0.25
Frequency			50 Hz
Additional equipment possible			Yes
Degree of protection (IP)			IP20
Construction size (in accordance with DIN 43880)			1
Width in number of modular spacings			4
Built-in depth		mm	69.5
Short-time delayed tripping			No

## Dimensions

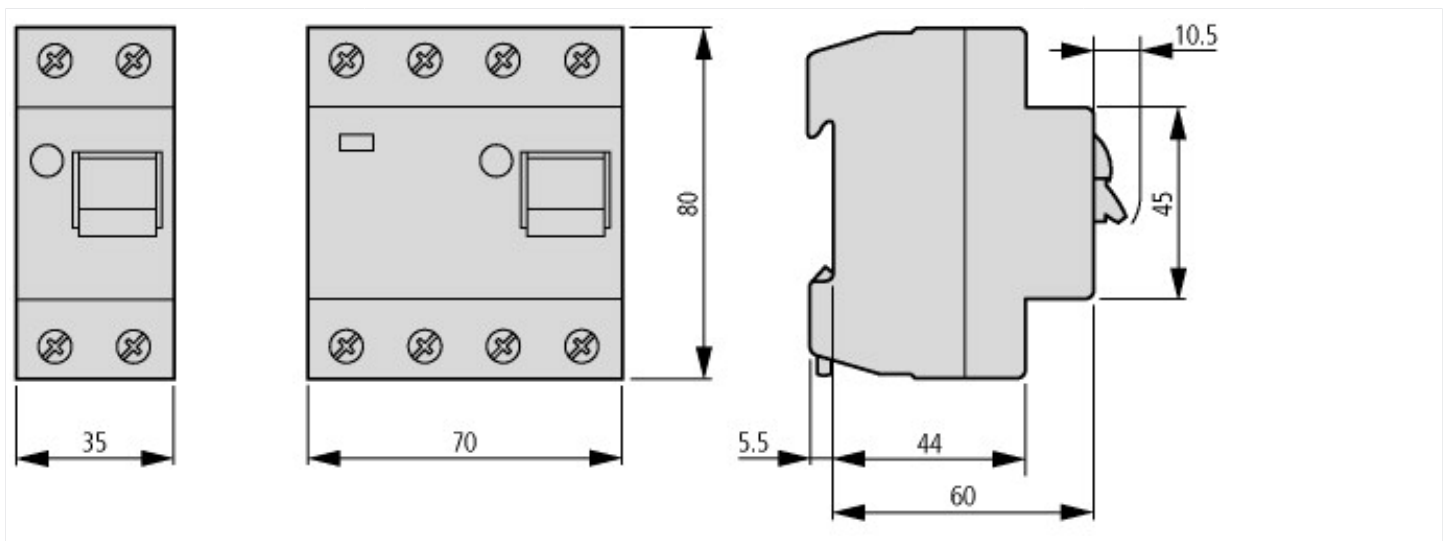

## Additional product information (links)

[AWA1290-1756 Residual-current-circuit-breaker](#)

