



Proximity switch, optical, long range 90cm, 18-30VDC, NPN, PNP, light, micro

Part no. E67-LRDP090-HLD
Article no. 100546
Catalog No. E67-LRDP090-HLD

Delivery program

Basic function			Optical sensors
Product range			E67 Long Range Series
For connection of:			Plug-in connection M12 x 1
Design (outer dimensions)		mm	Rectangular (166 x 59 x 43)
Rated operational voltage	U_e		18 – 30 V DC
Rated switching distance	S_n	mm	900
Description			with background suppression (Perfect Prox)
Connection			4-wire
Function			Reflected-light beam
Type of light			Infra-red
Switching type			NPN PNP
Switching principle			Light switching

Technical data

General

Ambient temperature			-35 - +55
Operation	θ	°C	-35 - +55
Storage	θ	°C	-40 - +70
Mechanical shock resistance		g	30 Shock duration 6 ms
Degree of Protection			IP67
Vibration			10 g (10 Hz - 2 kHz)

Characteristics

Rated switching distance			
Rated switching distance	S_n	mm	900
Rated operational voltage	U_e		18 – 30 V DC
Maximum load current	I_e	mA	< 100
Response time		ms	15
Switching state display		LED	Red
Operating voltage display		LED	Green
Connection			4-wire
Style			
Design (outer dimensions)		mm	Rectangular (166 x 59 x 43)
For connection of:			Plug-in connection M12 x 1

Design verification as per IEC/EN 61439

Technical data for design verification			
Operating ambient temperature min.		°C	-35
Operating ambient temperature max.		°C	55

Technical data ETIM 6.0

Sensors (EG000026) / Light scanner with background masking (EC002719)			
Electric engineering, automation, process control engineering / Binary sensor technology, safety-related sensor technology / Optoelectronic sensor / Light scanner w. background masking (ecl@ss8.1-27-27-09-04 [AKP253010])			
Adjustment range		mm	0 - 900
Operating distance		mm	0 - 0
Triangulation			Background fade-out
Pre failure notice			No

With time function		No
Rated switching distance	mm	900
Max. switching distance	mm	1200
Max. output current	mA	100
Reflector included		No
Analogue output 0 V ... 10 V		No
Analogue output 0 mA ... 20 mA		No
Analogue output 4 mA ... 20 mA		No
Analogue output -10 V ... +10 V		No
With other analog output		No
Setting procedure		-
With communication interface analog		No
With communication interface AS-Interface		No
With communication interface CANOpen		No
With communication interface DeviceNet		No
With communication interface Ethernet		No
With communication interface INTERBUS		No
With communication interface PROFIBUS		No
With communication interface RS-232		No
With communication interface RS-422		No
With communication interface RS-485		No
With communication interface SSD		No
With communication interface SSI		No
Number of semiconductor outputs with signalling function		2
Number of contact energized outputs with signalling function		0
Number of protected semiconductor outputs		0
Number of protected contact energized outputs		0
Type of interface for safety communication		-
Type of electric connection		-
Type of switching output		PNP/NPN
Type of switch function		-
Operation agent-safety class		Safety class 2
Explosion safety category for gas		None
Explosion safety category for dust		None
Construction type housing		Cuboid
Width sensor	mm	43
Diameter sensor	mm	0
Height of sensor	mm	59
Length of sensor	mm	166
Switch function		Light switching
Material of optical surface		Plastic
Material housing		Plastic
Max. output current at protected output	mA	0
Min. reflector distance	mm	0
Ambient temperature	°C	-35 - 55
Time of reaction	ms	15
Transmission range of the safety field	m	0
Switching frequency	Hz	0
Type of safety acc. IEC 61496-1		-
Switching voltage of OSSD at state "high"	V	30
Rated control supply voltage Us at AC 50HZ	V	0 - 0
Rated control supply voltage Us at AC 60HZ	V	0 - 0
Rated control supply voltage Us at DC	V	18 - 30
Voltage type		DC
With monitoring function downstream switching devices		No

Laser protection class		None
Wavelength of the sensor	nm	0
Type of light		Infrared light
Light dot	mm ²	0
AWG-number		0
Material of cable sheath		-
With restart blockage		No
Suitable for safety functions		No
Degree of protection (IP)		IP67

Approvals

Product Standards		CE marking
Max. Voltage Rating		30 V DC

Dimensions

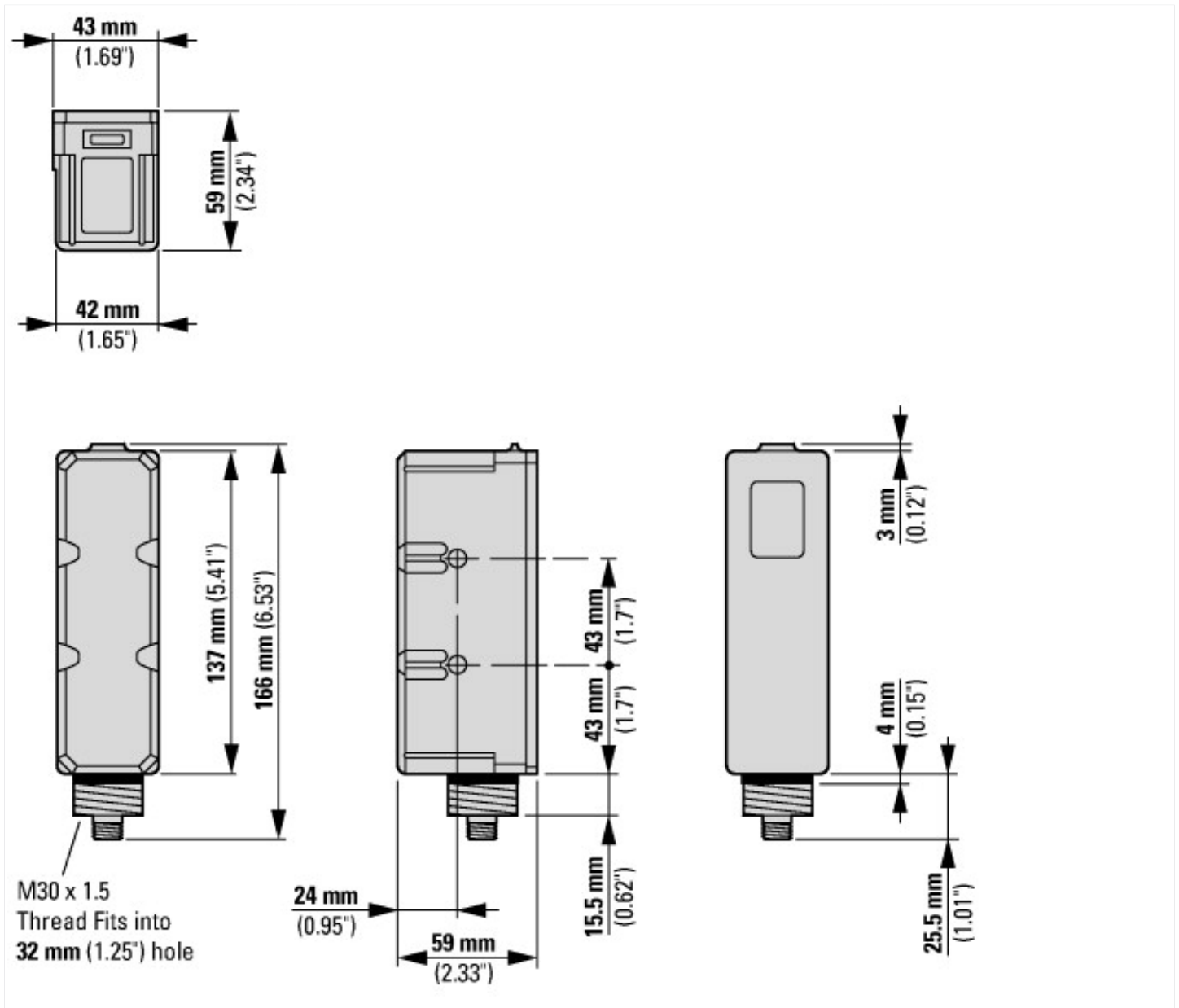

Additional product information (links)

IL05305005Z E67 Series Optical Sensors with Perfect Prox Background Rejection

IL05305005Z E67 Series Optical Sensors with Perfect Prox Background Rejection ftp://ftp.moeller.net/DOCUMENTATION/AWA_INSTRUCTIONS/IL05305005Z2016_07.pdf