



Diffuse reflective sensor, $S_n=50\text{mm}$, 4L, 10-30VDC, dark, NPN, PNP, M18, metal, M12



Powering Business Worldwide™

Part no. E58-18DP50-HDP
Article no. 135671
Catalog No. E58-18DP50-HDP

Delivery program

Basic function			Optical sensors
Product range			E58 Harsh Duty Series
For connection of:			Plug-in connection M12 x 1
Design (outer dimensions)		mm	M18 x 1
Rated operational voltage	U_e		10 - 30 V DC
Rated switching distance	S_n	mm	50
Description			with background suppression (Perfect Prox)
Connection			4-wire
Function			Reflected-light beam
Type of light			Visible red
Material			Stainless steel
Switching type			NPN PNP
Switching principle			Dark switching
Information relevant for export to North America			
Product Standards UL 508; CSA-C22.2 No. 14; IEC60947-5-2; CE marking			
UL File No. E166051			
UL Category Control No. NRKH, NRKH7			
CSA File No. UL report applies to both Canada and US			
CSA Class No. –			
North America Certification UL listed, certified by UL for use in Canada			
Max. Voltage Rating 30 V DC			
Degree of Protection IEC: IP68, IP69K; UL/CSA Type: 1, 2, 3, 3R, 3S, 4, 4x, 6, 6P, 12, 12K, 13			

Technical data

General

Standards			IEC/EN 60947-5-2
Ambient temperature			-40 - +55
Mechanical shock resistance		g	100 Shock duration 3 ms
Degree of Protection			IP69K

Characteristics

Rated switching distance			
Rated switching distance	S_n	mm	50
Range		mm	0.05
Rated operational voltage	U_e		10 - 30 V DC
Maximum load current	I_e	mA	< PNP: 100 NPN: 250
Response time		ms	1
Switching state display		LED	Red
Protective functions			Short-circuit protective device Protection against polarity reversal Protection against wire breakage
Connection			4-wire
Style			
Design (outer dimensions)		mm	M18 x 1
For connection of:			Plug-in connection M12 x 1
Material			Stainless steel

Design verification as per IEC/EN 61439

Technical data for design verification			
Operating ambient temperature min.		°C	-40
Operating ambient temperature max.		°C	55

Technical data ETIM 6.0

Sensors (EG000026) / Light scanner with background masking (EC002719)			
Electric engineering, automation, process control engineering / Binary sensor technology, safety-related sensor technology / Optoelectronic sensor / Light scanner w. background masking (ecl@ss8.1-27-27-09-04 [AKP253010])			
Adjustment range		mm	0 - 50
Operating distance		mm	0 - 0
Triangulation			Background fade-out
Pre failure notice			No
With time function			No
Rated switching distance		mm	50
Max. switching distance		mm	57
Max. output current		mA	250
Reflector included			No
Analogue output 0 V ... 10 V			No
Analogue output 0 mA ... 20 mA			No
Analogue output 4 mA ... 20 mA			No
Analogue output -10 V ... +10 V			No
With other analog output			No
Setting procedure			-
With communication interface analog			No
With communication interface AS-Interface			No
With communication interface CANOpen			No
With communication interface DeviceNet			No
With communication interface Ethernet			No
With communication interface INTERBUS			No
With communication interface PROFIBUS			No
With communication interface RS-232			No
With communication interface RS-422			No
With communication interface RS-485			No
With communication interface SSD			No
With communication interface SSI			No
Number of semiconductor outputs with signalling function			2
Number of contact energized outputs with signalling function			0
Number of protected semiconductor outputs			0
Number of protected contact energized outputs			0
Type of interface for safety communication			-
Type of electric connection			Connector M12
Type of switching output			PNP/NPN
Type of switch function			-
Operation agent-safety class			Safety class 2
Explosion safety category for gas			None
Explosion safety category for dust			None
Construction type housing			Cylinder, screw-thread
Width sensor		mm	0
Diameter sensor		mm	18
Height of sensor		mm	0
Length of sensor		mm	80
Switch function			Dark switching
Material of optical surface			Glass
Material housing			Metal
Max. output current at protected output		mA	0

Min. reflector distance	mm	0
Ambient temperature	°C	-40 - 55
Time of reaction	ms	1
Transmission range of the safety field	m	0
Switching frequency	Hz	500
Type of safety acc. IEC 61496-1		-
Switching voltage of OSSD at state "high"	V	30
Rated control supply voltage Us at AC 50HZ	V	0 - 0
Rated control supply voltage Us at AC 60HZ	V	0 - 0
Rated control supply voltage Us at DC	V	10 - 30
Voltage type		DC
With monitoring function downstream switching devices		No
Laser protection class		None
Wavelength of the sensor	nm	660
Type of light		-
Light dot	mm ²	0
AWG-number		0
Material of cable sheath		-
With restart blockage		No
Suitable for safety functions		No
Degree of protection (IP)		IP67

Approvals

Product Standards		UL 508; CSA-C22.2 No. 14; IEC60947-5-2; CE marking
UL File No.		E166051
UL Category Control No.		NRKH, NRKH7
CSA File No.		UL report applies to both Canada and US
CSA Class No.		-
North America Certification		UL listed, certified by UL for use in Canada
Max. Voltage Rating		30 V DC
Degree of Protection		IEC: IP68, IP69K; UL/CSA Type: 1, 2, 3, 3R, 3S, 4, 4x, 6, 6P, 12, 12K, 13

Dimensions

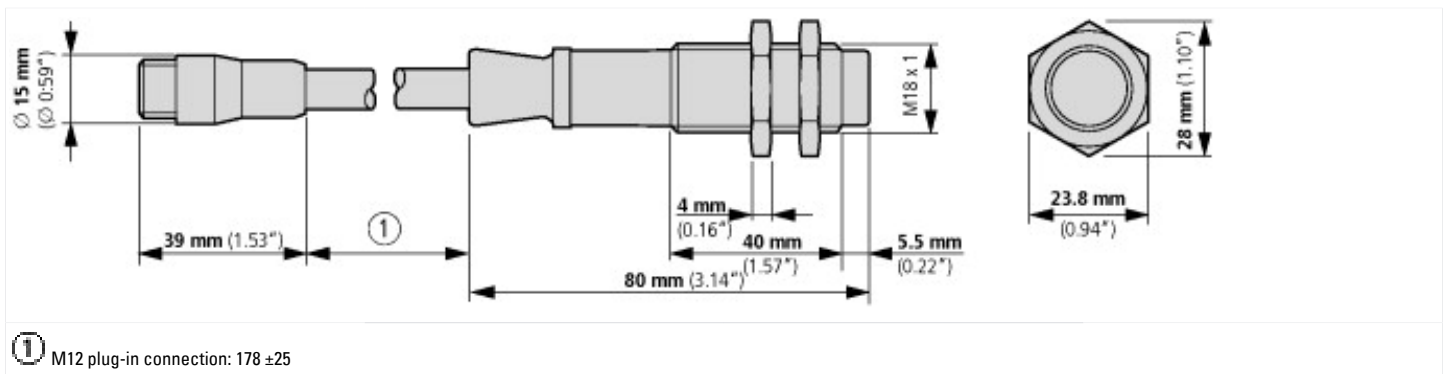

Additional product information (links)

IL05305003Z E58 Series Harsh Environment Optical Sensors

IL05305003Z E58 Series Harsh Environment Optical Sensors ftp://ftp.moeller.net/DOCUMENTATION/AWA_INSTRUCTIONS/IL05305003Z2016_07.pdf