

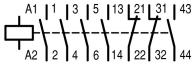
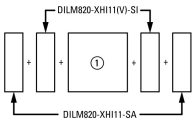

**Contactor, 3p+2N/O+2N/C, 450kW/400V/AC3**

**Part no. DILM820/22(RA110)**  
**Article no. 208224**  
**Catalog No. XTCE820N22Y**

## Delivery program

Product range			Contactors
Application			Contactors for Motors
Subrange			Comfort devices greater than 170 A
Utilization category			AC-1: Non-inductive or slightly inductive loads, resistance furnaces NAC-3: Normal AC induction motors: starting, switch off during running AC-4: Normal AC induction motors: starting, plugging, reversing, inching
Connection technique			Screw connection
<b>Rated operational current</b>			
AC-1			
Conventional free air thermal current, 3 pole, 50 - 60 Hz			
Open			
at 40 °C	$I_{th} = I_e$	A	1225
Conventional free air thermal current, 1 pole			
open	$I_{th}$	A	2500
<b>Max. rating for three-phase motors, 50 - 60 Hz</b>			
AC-3			
220 V 230 V	P	kW	260
380 V 400 V	P	kW	450
660 V 690 V	P	kW	750
1000 V	P	kW	800
AC-4			
220 V 230 V	P	kW	209
380 V 400 V	P	kW	355
660 V 690 V	P	kW	633
1000 V	P	kW	678
Contact sequence			
Can be combined with auxiliary contact			DILM820-XHI...
Actuating voltage			RA 110: 48 - 110 V 40 - 60 Hz/48 - 110 V DC
Voltage AC/DC			AC and DC operation
<b>Contacts</b>			
N/O = Normally open			2 N/O
N/C = Normally closed			2 NC
<b>Auxiliary contacts</b>			
possible variants at auxiliary contact module fitting options			on the side: 2 x DILM820-XHI11(V)-SI; 2 x DILM820-XHI11-SA
Side mounting auxiliary contacts			
<b>Instructions</b>			integrated suppressor circuit in actuating electronics 660 V, 690 V or 1000 V: not directly reversing

## Technical data

<b>General</b>			
Standards			IEC/EN 60947, VDE 0660, UL, CSA
Lifespan, mechanical			
AC operated	Operations	$\times 10^6$	5
DC operated	Operations	$\times 10^6$	5
Operating frequency, mechanical			

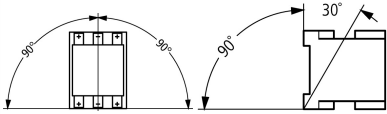
AC operated	Operations/h		1000
DC operated	Operations/h		1000
Climatic proofing			Damp heat, constant, to IEC 60068-2-78 Damp heat, cyclic, to IEC 60068-2-30
Ambient temperature			
Open	°C		-40 - +60
Enclosed	°C		-40 - +40
Storage	°C		-40 - +80
Mounting position			
Mechanical shock resistance (IEC/EN 60068-2-27)			
Half-sinusoidal shock, 10 ms			
Main contacts			
N/O contact	g		10
Auxiliary contacts			
N/O contact	g		10
N/C contact	g		8
Degree of Protection			IP00
Protection against direct contact when actuated from front (EN 50274)			Finger and back-of-hand proof with terminal shroud or terminal block
Weight			
AC operated	kg		16.54
DC operated	kg		16.54
Weight	kg		16.54
Terminal capacity main cable			
Flexible with cable lug	mm <sup>2</sup>		50 - 240
Stranded with cable lug	mm <sup>2</sup>		70 - 240
Solid or stranded	AWG		2/0 - 500 MCM
Flat conductor	Lamellenzahl x Breite x Dicke	mm	Fixing with flat cable terminal or cable terminal blocks See terminal capacity for cable terminal blocks
Busbar	Breite	mm	60
Main cable connection screw/bolt			M12
Tightening torque	Nm		35
Terminal capacity control circuit cables			
Solid	mm <sup>2</sup>		1 x (0.75 - 2.5) 2 x (0.75 - 2.5)
Flexible with ferrule	mm <sup>2</sup>		1 x (0.75 - 2.5) 2 x (0.75 - 2.5)
Solid or stranded	AWG		2 x (18 - 12)
Control circuit cable connection screw/bolt			M3.5
Tightening torque	Nm		1.2
Tool			
Main cable			
Width across flats	mm		18
Control circuit cables			
Pozidriv screwdriver	Size		2

### Main conducting paths

Rated impulse withstand voltage	U <sub>imp</sub>	V AC	8000
Overvoltage category/pollution degree			III/3
Rated insulation voltage	U <sub>i</sub>	V AC	1000
Rated operational voltage	U <sub>e</sub>	V AC	1000
Safe isolation to EN 61140			
between coil and contacts		V AC	500
between the contacts		V AC	500
Making capacity (p.f. to IEC/EN 60947)		A	9840

<b>Breaking capacity</b>			
220 V 230 V		A	8200
380 V 400 V		A	8200
500 V		A	8200
660 V 690 V		A	8200
1000 V		A	5800
<b>Component lifespan</b>			
			AC1: See → Engineering, characteristic curves AC3: See → Engineering, characteristic curves AC4: See → Engineering, characteristic curves
<b>Short-circuit rating</b>			
Short-circuit protection maximum fuse			
Type "2" coordination			
400 V	gG/gL 500 V	A	630
690 V	gG/gL 690 V	A	630
1000 V	gG/gL 1000 V	A	630
Type "1" coordination			
400 V	gG/gL 500 V	A	1200
690 V	gG/gL 690 V	A	1200
1000 V	gG/gL 1000 V	A	800

## AC

<b>AC-1</b>			
Rated operational current			
Conventional free air thermal current, 3 pole, 50 - 60 Hz			
Open			
at 40 °C	$I_{th} = I_e$	A	1225
at 50 °C	$I_{th} = I_e$	A	1095
at 55 °C	$I_{th} = I_e$	A	1044
at 60 °C	$I_{th} = I_e$	A	1000
Conventional free air thermal current, 1 pole			
Note			
open	$I_{th}$	A	at maximum permissible ambient air temperature 2500
<b>AC-3</b>			
Rated operational current			
Open, 3-pole: 50 – 60 Hz			
220 V 230 V	$I_e$	A	820
240 V	$I_e$	A	820
415 V	$I_e$	A	820
440V	$I_e$	A	820
500 V	$I_e$	A	820
660 V 690 V	$I_e$	A	820
1000 V	$I_e$	A	580
Motor rating			
	P	kWh	
220 V 230 V	P	kW	260
240V	P	kW	285
380 V 400 V	P	kW	450
415 V	P	kW	500
440 V	P	kW	450
500 V	P	kW	600
660 V 690 V	P	kW	750
1000 V	P	kW	800
<b>AC-4</b>			
Rated operational current			
Open, 3-pole: 50 – 60 Hz			
220 V 230 V	$I_e$	A	656

240 V	I <sub>e</sub>	A	656
380 V 400 V	I <sub>e</sub>	A	656
415 V	I <sub>e</sub>	A	656
440 V	I <sub>e</sub>	A	656
500 V	I <sub>e</sub>	A	656
660 V 690 V	I <sub>e</sub>	A	656
1000 V	I <sub>e</sub>	A	464
Motor rating	P	kWh	
220 V 230 V	P	kW	209
240 V	P	kW	228
380 V 400 V	P	kW	355
415 V	P	kW	394
440 V	P	kW	418
500 V	P	kW	474
660 V 690 V	P	kW	633
1000 V	P	kW	678



### Condensator operation

Individual compensation, rated operational current I <sub>e</sub> of three-phase capacitors			
Open			
up to 525 V		A	463
690 V		A	265
Max. inrush current peak		x I <sub>e</sub>	30
Component lifespan	Operations	x 10 <sup>6</sup>	0.1
Max. operating frequency		Ops/h	200

### Current heat loss

3-pole at I <sub>th</sub>		W	96
Current heat loss at I <sub>e</sub> to AC-3/400 V		W	65

### Magnet systems

Voltage tolerance			
U <sub>S</sub>			48 - 110 V 40-60 Hz 48 - 110 V DC
AC operated	Pick-up	x U <sub>S</sub>	0.7 x U <sub>S min</sub> - 1.15 x U <sub>S max</sub>
DC operated	Pick-up	x U <sub>S</sub>	0.7 x U <sub>S min</sub> - 1.15 x U <sub>S max</sub>
AC operated	Drop-out	x U <sub>S</sub>	0.2 x U <sub>S max</sub> - 0.6 x U <sub>S min</sub>
DC operated	Drop-out	x U <sub>S</sub>	0.2 x U <sub>S max</sub> - 0.6 x U <sub>S min</sub>
Power consumption of the coil in a cold state and 1.0 x U <sub>c</sub>			
Note on power consumption			Control transformer with u <sub>k</sub>  0.7
Pull-in power	Pick-up	VA	800
Pull-in power	Pick-up	W	700
Sealing power	Sealing	VA	7.5
Sealing power	Sealing	W	6.5
Duty factor		% DF	100
Changeover time at 100 % U <sub>c</sub> (recommended value)			
Main contacts			
Closing delay		ms	70
Opening delay		ms	110
Behaviour in marginal and transitional conditions			
Sealing			
Voltage interruptions			
(0 ... 0.2 x U <sub>c min</sub> )  10 ms			Time is bridged successfully
(0 ... 0.2 x U <sub>c min</sub> ) > 10 ms			Drop-out of the contactor
Voltage drops			
(0.2 ... 0.6 x U <sub>c min</sub> )  12 ms			Time is bridged successfully

$(0.2 \dots 0.6 \times U_{c \min}) > 12 \text{ ms}$			Drop-out of the contactor
$(0.6 \dots 0.7 \times U_{c \min})$			Contactor remains switched on
Excess voltage			
$(1.15 \dots 1.3 \times U_{c \max})$			Contactor remains switched on
Pick-up phase			
$(0 \dots 0.7 \times U_{c \min})$			Contactor does not switch on
$(0.7 \times U_{c \min} \dots 1.15 \times U_{c \max})$			Contactor switches on with certainty
Admissible transitional contact resistance (of the external control circuit device when actuating A11)		mΩ	 500
PLC signal level (A3 - A4) to IEC/EN 61131-2 (type 2)			
High		V	15
Low		V	5

### Electromagnetic compatibility (EMC)

Electromagnetic compatibility			This product is designed for operation in industrial environments (environment 2). The use in residential environments (environment 1) could cause electrical interference so that addition suppression must be planned.
-------------------------------	--	--	--

## Design verification as per IEC/EN 61439

Technical data for design verification			
Rated operational current for specified heat dissipation	$I_n$	A	820
Heat dissipation per pole, current-dependent	$P_{vid}$	W	21.67
Equipment heat dissipation, current-dependent	$P_{vid}$	W	0
Static heat dissipation, non-current-dependent	$P_{vs}$	W	6.5
Heat dissipation capacity	$P_{diss}$	W	0
Operating ambient temperature min.		°C	-40
Operating ambient temperature max.		°C	60
IEC/EN 61439 design verification			
10.2 Strength of materials and parts			
10.2.2 Corrosion resistance			Meets the product standard's requirements.
10.2.3.1 Verification of thermal stability of enclosures			Meets the product standard's requirements.
10.2.3.2 Verification of resistance of insulating materials to normal heat			Meets the product standard's requirements.
10.2.3.3 Verification of resistance of insulating materials to abnormal heat and fire due to internal electric effects			Meets the product standard's requirements.
10.2.4 Resistance to ultra-violet (UV) radiation			Meets the product standard's requirements.
10.2.5 Lifting			Does not apply, since the entire switchgear needs to be evaluated.
10.2.6 Mechanical impact			Does not apply, since the entire switchgear needs to be evaluated.
10.2.7 Inscriptions			Meets the product standard's requirements.
10.3 Degree of protection of ASSEMBLIES			Does not apply, since the entire switchgear needs to be evaluated.
10.4 Clearances and creepage distances			Meets the product standard's requirements.
10.5 Protection against electric shock			Does not apply, since the entire switchgear needs to be evaluated.
10.6 Incorporation of switching devices and components			Does not apply, since the entire switchgear needs to be evaluated.
10.7 Internal electrical circuits and connections			Is the panel builder's responsibility.
10.8 Connections for external conductors			Is the panel builder's responsibility.
10.9 Insulation properties			
10.9.2 Power-frequency electric strength			Is the panel builder's responsibility.
10.9.3 Impulse withstand voltage			Is the panel builder's responsibility.
10.9.4 Testing of enclosures made of insulating material			Is the panel builder's responsibility.
10.10 Temperature rise			The panel builder is responsible for the temperature rise calculation. Eaton will provide heat dissipation data for the devices.
10.11 Short-circuit rating			Is the panel builder's responsibility. The specifications for the switchgear must be observed.
10.12 Electromagnetic compatibility			Is the panel builder's responsibility. The specifications for the switchgear must be observed.
10.13 Mechanical function			The device meets the requirements, provided the information in the instruction leaflet (IL) is observed.

## Technical data ETIM 6.0

Low-voltage industrial components (EG000017) / Power contactor, AC switching (EC000066)

Rated control supply voltage $U_s$ at AC 50HZ	V	48 - 110
Rated control supply voltage $U_s$ at AC 60HZ	V	48 - 110
Rated control supply voltage $U_s$ at DC	V	48 - 110
Voltage type for actuating		AC/DC
Rated operation current $I_e$ at AC-1, 400 V	A	1225
Rated operation current $I_e$ at AC-3, 400 V	A	820
Rated operation power at AC-3, 400 V	kW	450
Rated operation current $I_e$ at AC-4, 400 V	A	656
Rated operation power $I_e$ at AC-4, 400 V	kW	355
Modular version		No
Number of auxiliary contacts as normally open contact		2
Number of auxiliary contacts as normally closed contact		2
Type of electrical connection of main circuit		Rail connection
Number of normally closed contacts as main contact		0
Number of main contacts as normally open contact		3

## Approvals

Product Standards		IEC/EN 60947-4-1; UL 508; CSA-C22.2 No. 14-05; CE marking
UL File No.		E29096
UL Category Control No.		NLDX
CSA File No.		012528
CSA Class No.		3211-04
North America Certification		UL listed, CSA certified
Specially designed for North America		No

## Characteristics

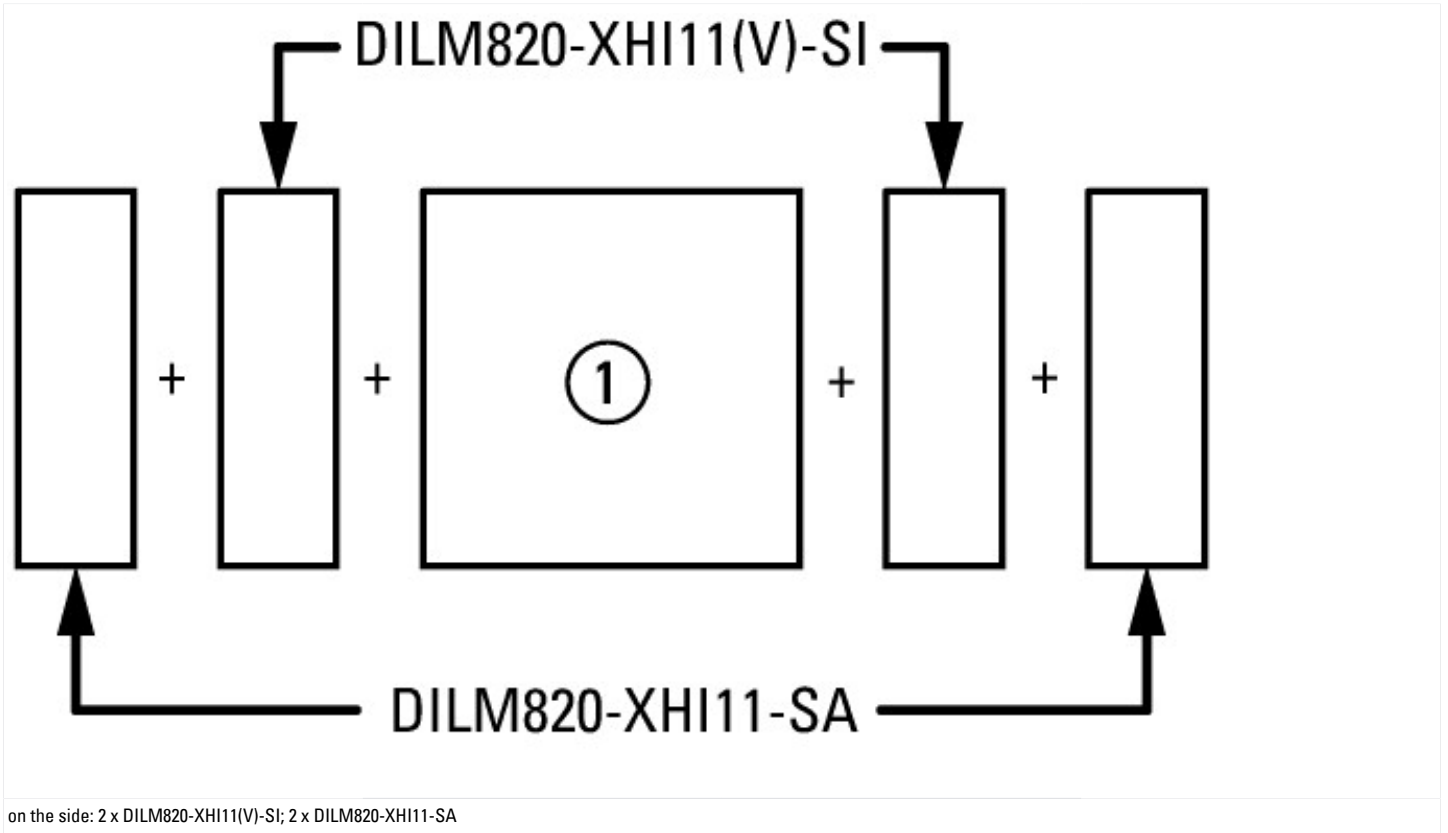

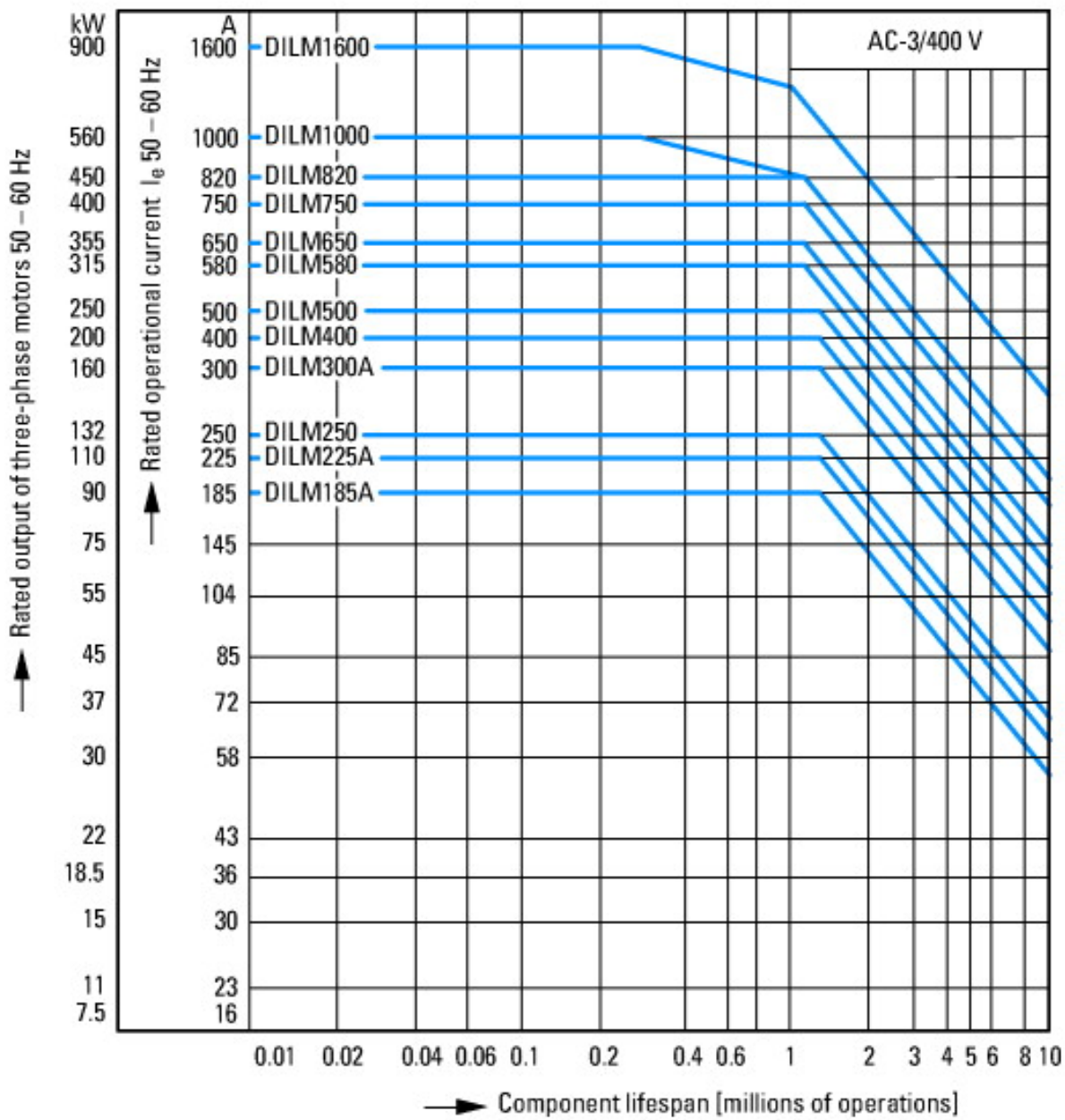

- Normal switching duty
- Normal AC induction motor
- Operating characteristics
- Switch on: from stop
- Switch off: during run
- Electrical characteristics:
- Switch on: up to 6 x Rated motor current
- Switch off: up to 1 x Rated motor current
- Utility category
- 100 % AC-3
- Typical Applications
- Compressors
- Lifts
- Mixers
- Pumps
- Escalators
- Agitators
- fan
- Conveyor belts
- Centrifuges
- Hinged flaps
- Bucket-elevator
- Air-conditioning systems
- General drives for manufacturing and processing machines

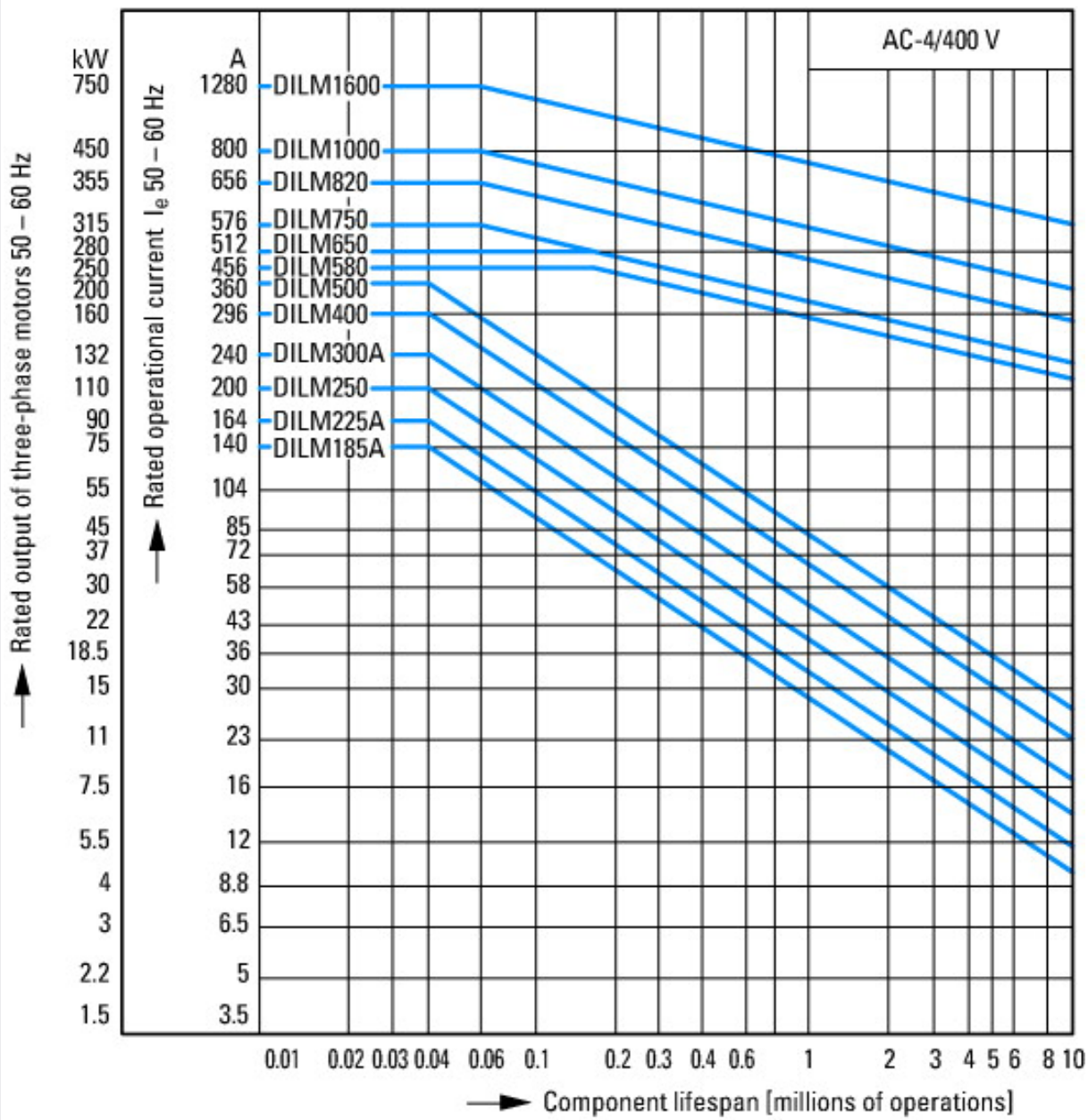

- Extreme switching duty
- Squirrel-cage motor
- Operating characteristics
- Inching, plugging, reversing
- Electrical characteristics
- Make: up to 6 x rated motor current
- Break: up to 6 x rated motor current
- Utilization category
- 100 % AC-4
- Typical applications
- Printing presses
- Wire-drawing machines
- Centrifuges
- Special drives for manufacturing and processing machines



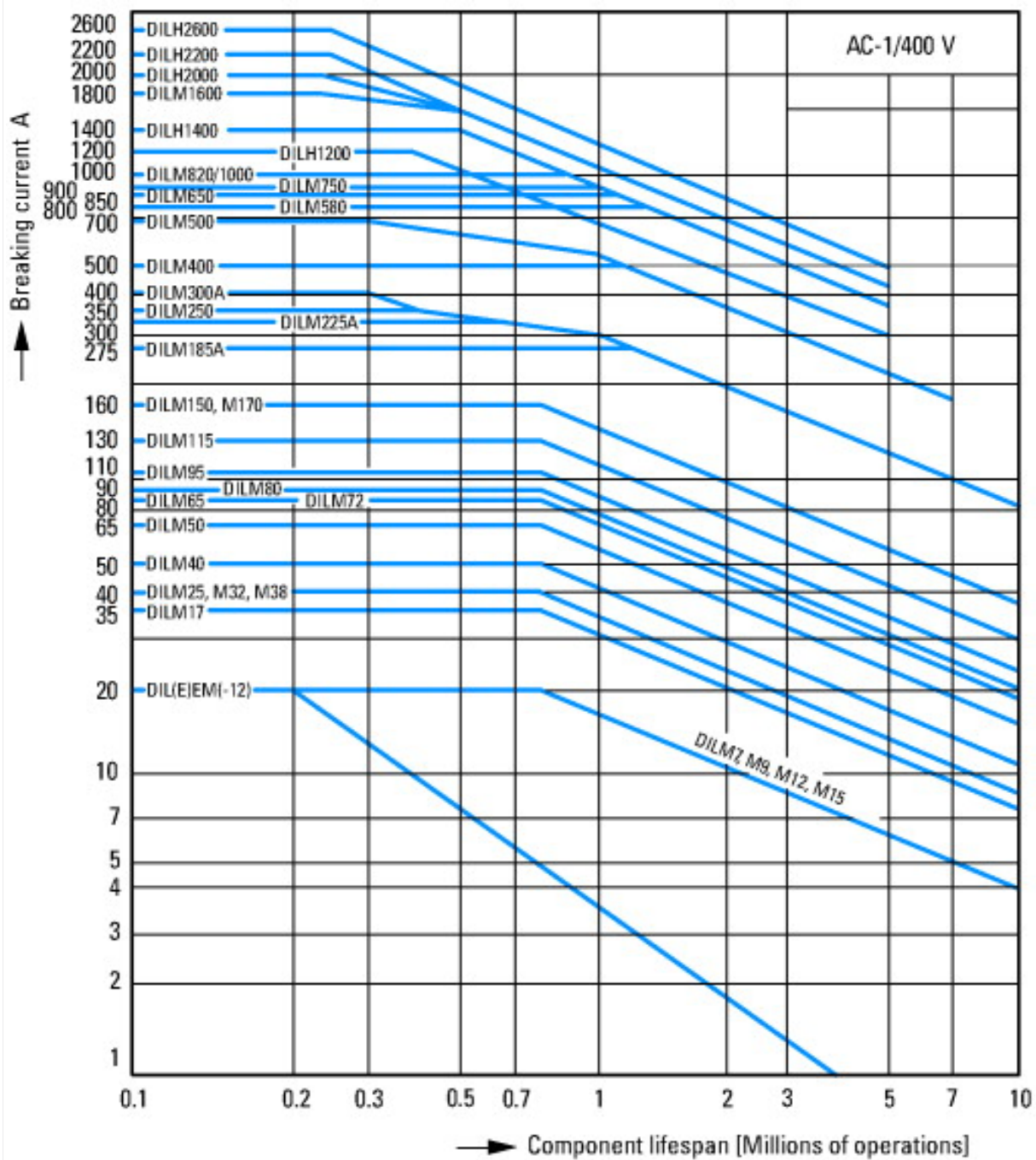

Switching conditions for 3 pole, non-motor loads  
 Operating characteristics  
 Non inductive and slightly inductive loads  
 Electrical characteristics  
 Switch on: 1 x rated operational current  
 Switch off: 1 x rated operational current  
 Utilization category  
 100 % AC-1  
 Typical examples of application  
 Electric heat

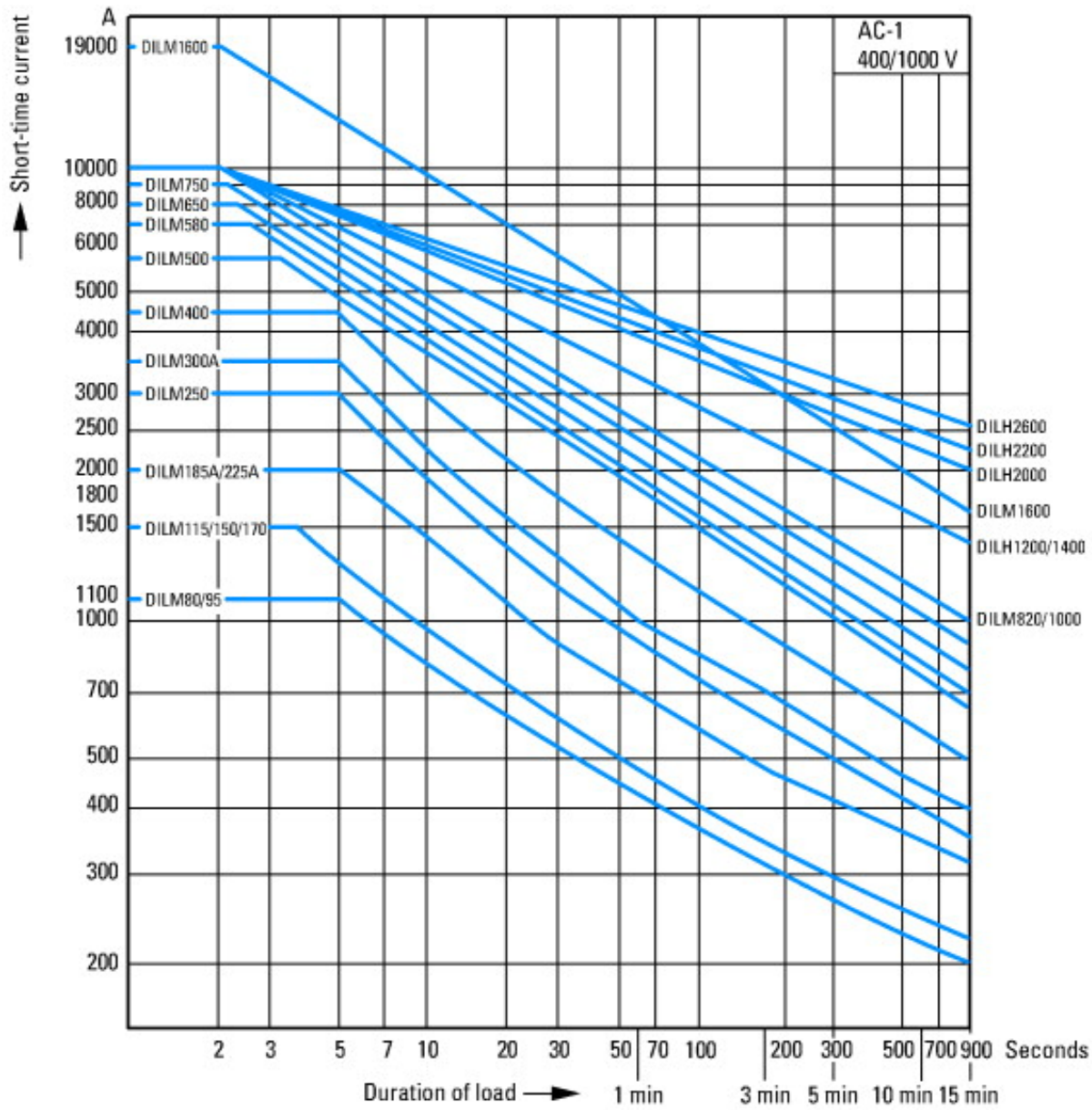

Short-time loading, 3-pole  
Time interval between two loading cycles: 15 minutes

## Dimensions

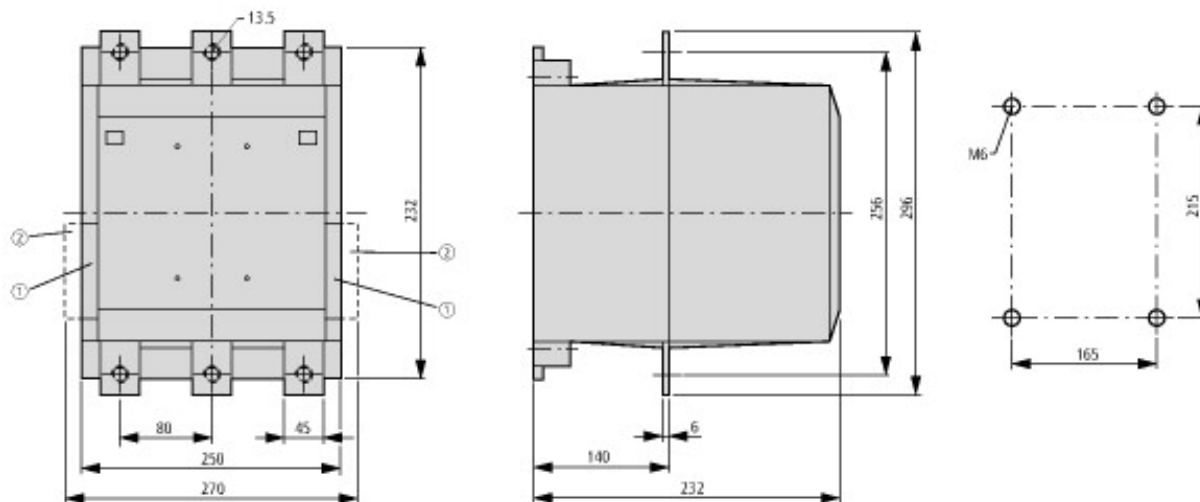

- ① DILM820-XHI11(V)-SI
- ② DILM820-XHI11-SA

## Additional product information (links)

### IL03407023Z (AWA2100-1697) Contactors >170 A

IL03407023Z (AWA2100-1697) Contactors >170 A [ftp://ftp.moeller.net/DOCUMENTATION/AWA\\_INSTRUCTIONS/IL03407023Z2011\\_11.pdf](ftp://ftp.moeller.net/DOCUMENTATION/AWA_INSTRUCTIONS/IL03407023Z2011_11.pdf)

UL/CSA: Approved rating data <http://de.ecat.moeller.net/flip-cat/?edition=HPLTE&startpage=5.84>

UL/CSA: UL/CSA: Short Circuit Current Rating (SCCR) <http://de.ecat.moeller.net/flip-cat/?edition=HPLTE&startpage=5.86>

Switchgear of Power Factor Correction Systems [http://www.moeller.net/binary/ver\\_techpapers/ver934en.pdf](http://www.moeller.net/binary/ver_techpapers/ver934en.pdf)

X-Start - Modern Switching Installations Efficiently Fitted and Wired Securely [http://www.moeller.net/binary/ver\\_techpapers/ver938en.pdf](http://www.moeller.net/binary/ver_techpapers/ver938en.pdf)

Mirror Contacts for Highly-Reliable Information Relating to Safety-Related Control Functions [http://www.moeller.net/binary/ver\\_techpapers/ver944en.pdf](http://www.moeller.net/binary/ver_techpapers/ver944en.pdf)

Effect of the Cable Capacitance of Long Control Cables on the Actuation of Contactors [http://www.moeller.net/binary/ver\\_techpapers/ver949en.pdf](http://www.moeller.net/binary/ver_techpapers/ver949en.pdf)

Motor starters and "Special Purpose Ratings" for the North American market [http://www.moeller.net/binary/ver\\_techpapers/ver953en.pdf](http://www.moeller.net/binary/ver_techpapers/ver953en.pdf)

Switchgear for Luminaires [http://www.moeller.net/binary/ver\\_techpapers/ver955en.pdf](http://www.moeller.net/binary/ver_techpapers/ver955en.pdf)

Standard Compliant and Functionally Safe Engineering Design with Mechanical Auxiliary Contacts [http://www.moeller.net/binary/ver\\_techpapers/ver956en.pdf](http://www.moeller.net/binary/ver_techpapers/ver956en.pdf)

The Interaction of Contactors with PLCs [http://www.moeller.net/binary/ver\\_techpapers/ver957en.pdf](http://www.moeller.net/binary/ver_techpapers/ver957en.pdf)

Busbar Component Adapters for modern Industrial control panels [http://www.moeller.net/binary/ver\\_techpapers/ver960en.pdf](http://www.moeller.net/binary/ver_techpapers/ver960en.pdf)