

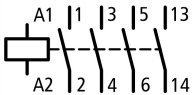

**Contactor, 3p+1N/O, 5.5kW/400V/AC3**

**Part no. DILM12-10(24V50/60HZ)**  
**Article no. 276834**  
**Catalog No. XTCE012B10T**

## Delivery program

Product range				Contactors
Application				Contactors for Motors
Subrange				Contactors up to 170 A, 3 pole
Utilization category				AC-1: Non-inductive or slightly inductive loads, resistance furnaces NAC-3: Normal AC induction motors: starting, switch off during running AC-4: Normal AC induction motors: starting, plugging, reversing, inching
				
Notes				Also suitable for motors with efficiency class IE3. IE3-ready devices are identified by the logo on their packaging.
Connection technique				Screw terminals
Number of poles				3 pole
<b>Rated operational current</b>				
AC-3				
380 V 400 V	$I_e$	A		12
AC-1				
Conventional free air thermal current, 3 pole, 50 - 60 Hz				
Open				
at 40 °C	$I_{th} = I_e$	A		22
enclosed	$I_{th}$	A		18
Conventional free air thermal current, 1 pole				
open	$I_{th}$	A		50
enclosed	$I_{th}$	A		45
<b>Max. rating for three-phase motors, 50 - 60 Hz</b>				
AC-3				
220 V 230 V	P	kW		3.5
380 V 400 V	P	kW		5.5
660 V 690 V	P	kW		6.5
AC-4				
220 V 230 V	P	kW		2
380 V 400 V	P	kW		3
660 V 690 V	P	kW		4.4
<b>Contacts</b>				
N/O = Normally open				1 N/O
Contact sequence				
<b>Instructions</b>				
Can be combined with auxiliary contact				DILM32-XHI.. DILA-XHI(V)..
Voltage AC/DC				AC operation

## Technical data

<b>General</b>				
Standards				IEC/EN 60947, VDE 0660, UL, CSA
Lifespan, mechanical				
AC operated	Operations	$\times 10^6$		10

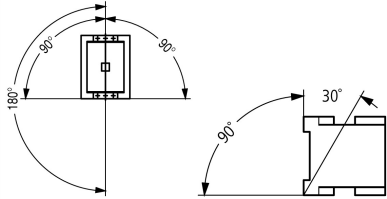
DC operated	Operations	x 10 <sup>6</sup>	10
<b>Operating frequency, mechanical</b>			
AC operated	Operations/h		5000
DC operated	Operations/h		5000
<b>Climatic proofing</b>			
			Damp heat, constant, to IEC 60068-2-78 Damp heat, cyclic, to IEC 60068-2-30
<b>Ambient temperature</b>			
Open		°C	-25 - +60
Enclosed		°C	- 25 - 40
Storage		°C	- 40 - 80
<b>Mounting position</b>			
			
<b>Mechanical shock resistance (IEC/EN 60068-2-27)</b>			
Half-sinusoidal shock, 10 ms			
<b>Main contacts</b>			
N/O contact		g	10
<b>Auxiliary contacts</b>			
N/O contact		g	7
N/C contact		g	5
<b>Mechanical shock resistance (IEC/EN 60068-2-27) when tabletop-mounted</b>			
Half-sinusoidal shock, 10 ms			
<b>Main contacts</b>			
N/O contact		g	5.7
<b>Auxiliary contacts</b>			
N/O contact		g	3.4
N/C contact		g	3.4
<b>Degree of Protection</b>			IP20
<b>Protection against direct contact when actuated from front (EN 50274)</b>			Finger and back-of-hand proof
<b>Weight</b>			
AC operated		kg	0.23
DC operated		kg	0.28
<b>Terminal capacity main cable</b>			
Solid		mm <sup>2</sup>	1 x (0.75 - 4) 2 x (0.75 - 2.5)
Flexible with ferrule		mm <sup>2</sup>	1 x (0.75 - 2.5) 2 x (0.75 - 2,5)
			Also without ferrule.
Solid or stranded		AWG	18 - 10
<b>Main cable connection screw/bolt</b>			M3.5
<b>Tightening torque</b>			Nm 1.2
<b>Terminal capacity control circuit cables</b>			
Solid		mm <sup>2</sup>	1 x (0.75 - 4) 2 x (0.75 - 2.5)
Flexible with ferrule		mm <sup>2</sup>	1 x (0.75 - 1.5) 2 x (0.75 - 1.5)
Solid or stranded		AWG	18 - 14
<b>Control circuit cable connection screw/bolt</b>			M3.5
<b>Tightening torque</b>			Nm 1.2
<b>Tool</b>			
<b>Main cable</b>			
Pozidriv screwdriver		Size	2
Standard screwdriver		mm	0.8 x 5.5 1 x 6
<b>Control circuit cables</b>			

Pozidriv screwdriver	Size	2
Standard screwdriver	mm	0.8 x 5.5 1 x 6

## Main conducting paths

Rated impulse withstand voltage	$U_{imp}$	V AC	8000
Overvoltage category/pollution degree			III/3
Rated insulation voltage	$U_i$	V AC	690
Rated operational voltage	$U_e$	V AC	690
Safe isolation to EN 61140			
between coil and contacts		V AC	400
between the contacts		V AC	400
Making capacity (p.f. to IEC/EN 60947)			
	$U_p$ to 690 V	A	144
Breaking capacity			
220 V 230 V		A	120
380 V 400 V		A	120
500 V		A	100
660 V 690 V		A	70
Short-circuit rating			
Short-circuit protection maximum fuse			
Type "2" coordination			
400 V	gG/gL 500 V	A	20
690 V	gG/gL 690 V	A	20
Type "1" coordination			
400 V	gG/gL 500 V	A	35
690 V	gG/gL 690 V	A	25

## AC

AC-1			
Rated operational current			
Conventional free air thermal current, 3 pole, 50 - 60 Hz			
Open			
at 40 °C	$I_{th} = I_e$	A	22
at 50 °C	$I_{th} = I_e$	A	21
at 55 °C	$I_{th} = I_e$	A	21
at 60 °C	$I_{th} = I_e$	A	20
enclosed	$I_{th}$	A	18
Conventional free air thermal current, 1 pole			
open	$I_{th}$	A	50
enclosed	$I_{th}$	A	45
AC-3			
Rated operational current			
Open, 3-pole: 50 – 60 Hz			
220 V 230 V	$I_e$	A	12
240 V	$I_e$	A	12
380 V 400 V	$I_e$	A	12
415 V	$I_e$	A	12
440V	$I_e$	A	12
500 V	$I_e$	A	10
660 V 690 V	$I_e$	A	7
380 V 400 V	$I_e$	A	12
Motor rating	P	kWh	
220 V 230 V	P	kW	3.5
240V	P	kW	4
380 V 400 V	P	kW	5.5
415 V	P	kW	7

440 V	P	kW	7.5
500 V	P	kW	7
660 V 690 V	P	kW	6.5
<b>AC-4</b>			
Open, 3-pole: 50 – 60 Hz			
220 V 230 V	I <sub>e</sub>	A	7
240 V	I <sub>e</sub>	A	7
380 V 400 V	I <sub>e</sub>	A	7
415 V	I <sub>e</sub>	A	7
440 V	I <sub>e</sub>	A	7
500 V	I <sub>e</sub>	A	6
660 V 690 V	I <sub>e</sub>	A	5
<b>Motor rating</b>			
220 V 230 V	P	kWh	
240 V	P	kW	2
380 V 400 V	P	kW	2.2
415 V	P	kW	3
440 V	P	kW	3.4
500 V	P	kW	3.6
660 V 690 V	P	kW	3.5
660 V 690 V	P	kW	4.4

## DC

<b>Rated operational current, open</b>			
<b>DC-1</b>			
60 V	I <sub>e</sub>	A	20
110 V	I <sub>e</sub>	A	20
220 V	I <sub>e</sub>	A	15
440 V	I <sub>e</sub>	A	1.3
<b>DC-3</b>			
60 V	I <sub>e</sub>	A	20
110 V	I <sub>e</sub>	A	20
220 V	I <sub>e</sub>	A	1.5
440 V	I <sub>e</sub>	A	0.2
<b>DC-5</b>			
60 V	I <sub>e</sub>	A	20
110 V	I <sub>e</sub>	A	20
220 V	I <sub>e</sub>	A	1.5
440 V	I <sub>e</sub>	A	0.2

## Current heat loss

3-pole at I <sub>th</sub>		W	2.7
Current heat loss at I <sub>e</sub> to AC-3/400 V		W	0.9
Impedance per pole		mΩ	2.5

## Magnet systems

<b>Voltage tolerance</b>			
AC operated	Pick-up	x U <sub>c</sub>	0.8 - 1.1
Drop-out voltage AC operated	Drop-out	x U <sub>c</sub>	0.3 - 0.6
DC operated	Pick-up	x U <sub>c</sub>	0.7 - 1.2
DC operated	Drop-out	x U <sub>c</sub>	0.15 - 0.6
Notes	at least smoothed two-phase bridge rectifier or three-phase rectifier		
<b>Power consumption of the coil in a cold state and 1.0 x U<sub>c</sub></b>			
50 Hz	Pick-up	VA	24
50 Hz	Sealing	VA	3.4
50 Hz	Sealing	W	1.2
60 Hz	Pick-up	VA	30
60 Hz	Sealing	VA	4.4

60 Hz	Sealing	W	1.4
50/60 Hz	Pick-up	VA	27 25
50/60 Hz	Sealing	VA	4.2 3.3
50/60 Hz	Sealing	W	1.4 1.2
DC operated	Pick-up	W	4.5
DC operated	Sealing	W	4.5
Duty factor		% DF	100
Changeover time at 100 % U <sub>C</sub> (recommended value)			
Main contacts			
AC operated			
Closing delay		ms	15 - 21
Opening delay		ms	9 - 18
DC operated			
Closing delay		ms	31
Opening delay		ms	12
Arcing time			
		ms	10
Lifespan, mechanical; Coil 50/60 Hz		x 10 <sup>6</sup>	Mechanical lifespan at 50 Hz approx. 30% lower than under "Technical data, general"

### Electromagnetic compatibility (EMC)

Emitted interference			to EN 60947-1
Interference immunity			to EN 60947-1

### Design verification as per IEC/EN 61439

Technical data for design verification			
Rated operational current for specified heat dissipation	I <sub>n</sub>	A	12
Heat dissipation per pole, current-dependent	P <sub>vid</sub>	W	0.3
Equipment heat dissipation, current-dependent	P <sub>vid</sub>	W	0
Static heat dissipation, non-current-dependent	P <sub>vs</sub>	W	1.4
Heat dissipation capacity	P <sub>diss</sub>	W	0
Operating ambient temperature min.		°C	-25
Operating ambient temperature max.		°C	60
IEC/EN 61439 design verification			
10.2 Strength of materials and parts			
10.2.2 Corrosion resistance			Meets the product standard's requirements.
10.2.3.1 Verification of thermal stability of enclosures			
10.2.3.2 Verification of resistance of insulating materials to normal heat			Meets the product standard's requirements.
10.2.3.3 Verification of resistance of insulating materials to abnormal heat and fire due to internal electric effects			Meets the product standard's requirements.
10.2.4 Resistance to ultra-violet (UV) radiation			Meets the product standard's requirements.
10.2.5 Lifting			Does not apply, since the entire switchgear needs to be evaluated.
10.2.6 Mechanical impact			Does not apply, since the entire switchgear needs to be evaluated.
10.2.7 Inscriptions			Meets the product standard's requirements.
10.3 Degree of protection of ASSEMBLIES			Does not apply, since the entire switchgear needs to be evaluated.
10.4 Clearances and creepage distances			Meets the product standard's requirements.
10.5 Protection against electric shock			Does not apply, since the entire switchgear needs to be evaluated.
10.6 Incorporation of switching devices and components			Does not apply, since the entire switchgear needs to be evaluated.
10.7 Internal electrical circuits and connections			Is the panel builder's responsibility.
10.8 Connections for external conductors			Is the panel builder's responsibility.
10.9 Insulation properties			
10.9.2 Power-frequency electric strength			Is the panel builder's responsibility.
10.9.3 Impulse withstand voltage			Is the panel builder's responsibility.
10.9.4 Testing of enclosures made of insulating material			Is the panel builder's responsibility.
10.10 Temperature rise			The panel builder is responsible for the temperature rise calculation. Eaton will provide heat dissipation data for the devices.

10.11 Short-circuit rating		Is the panel builder's responsibility. The specifications for the switchgear must be observed.
10.12 Electromagnetic compatibility		Is the panel builder's responsibility. The specifications for the switchgear must be observed.
10.13 Mechanical function		The device meets the requirements, provided the information in the instruction leaflet (IL) is observed.

## Technical data ETIM 6.0

Low-voltage industrial components (EG000017) / Power contactor, AC switching (EC000066)		
Electric engineering, automation, process control engineering / Low-voltage switch technology / Contactor (LV) / Power contactor, AC switching (ecl@ss8.1-27-37-10-03 [AAB718012])		
Rated control supply voltage Us at AC 50HZ	V	24 - 24
Rated control supply voltage Us at AC 60HZ	V	24 - 24
Rated control supply voltage Us at DC	V	0 - 0
Voltage type for actuating		AC
Rated operation current Ie at AC-1, 400 V	A	14
Rated operation current Ie at AC-3, 400 V	A	12
Rated operation power at AC-3, 400 V	kW	5.5
Rated operation current Ie at AC-4, 400 V	A	7
Rated operation power Ie at AC-4, 400 V	kW	3
Modular version		No
Number of auxiliary contacts as normally open contact		1
Number of auxiliary contacts as normally closed contact		0
Type of electrical connection of main circuit		Screw connection
Number of normally closed contacts as main contact		0
Number of main contacts as normally open contact		3

## Approvals

Product Standards		IEC/EN 60947-4-1; UL 508; CSA-C22.2 No. 14-05; CE marking
UL File No.		E29096
UL Category Control No.		NLDX
CSA File No.		012528
CSA Class No.		2411-03, 3211-04
North America Certification		UL listed, CSA certified
Specially designed for North America		No

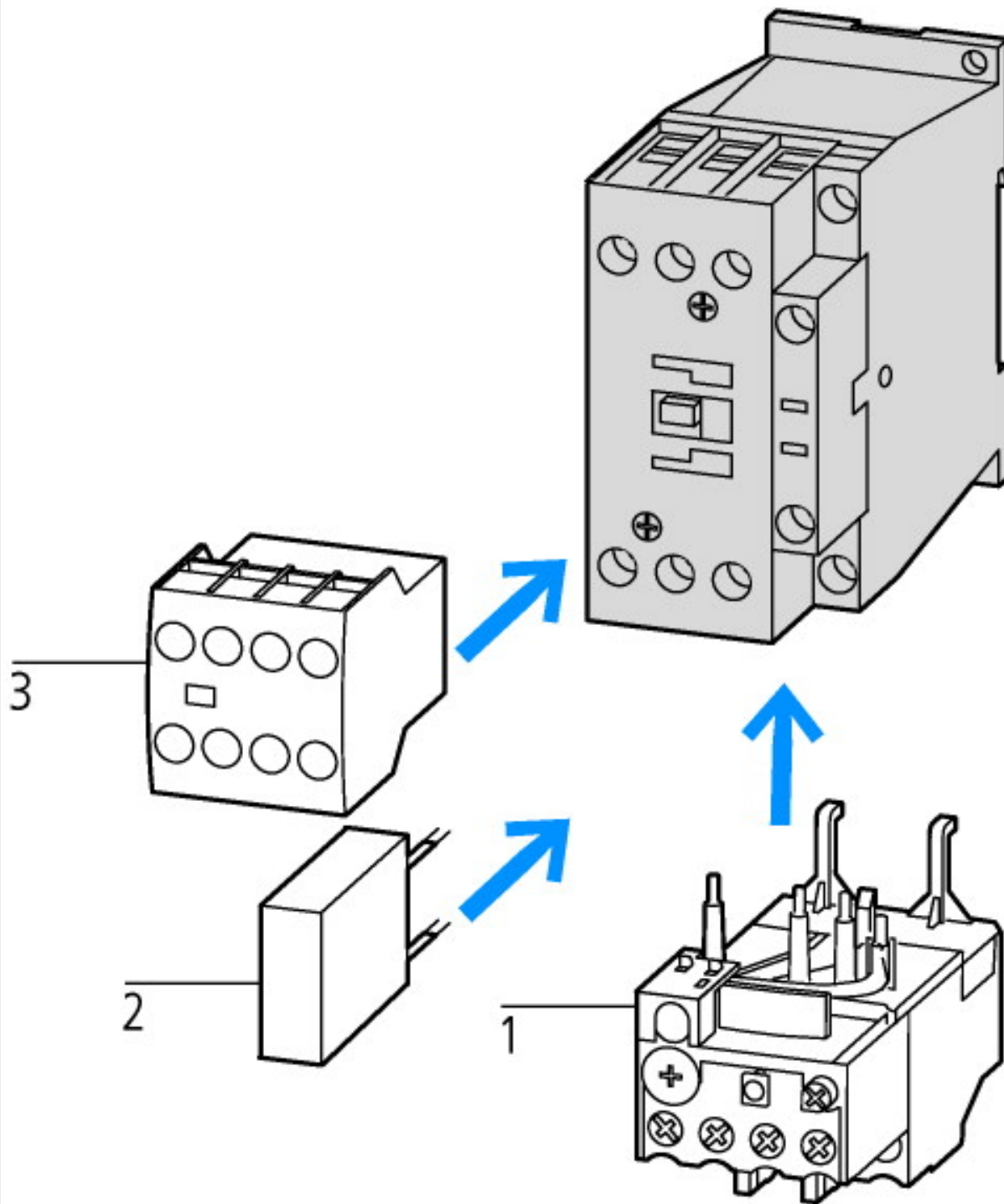

- 1: Overload relay
- 2: Suppressor
- 3: Auxiliary contact modules



- Squirrel-cage motor
- Operating characteristics
- Starting: from rest
- Stopping: after attaining full running speed
- Electrical characteristics
- Make: up to 6 x rated motor current
- Break: up to 1 x rated motor current
- Utilization category
- 100 % AC-3
- Typical applications
- Compressors
- Lifts
- Mixers
- Pumps
- Escalators
- Agitators
- Fans
- Conveyor belts
- Centrifuges
- Hinged flaps
- Bucket-elevators
- Air conditioning system
- General drives in manufacturing and processing machines



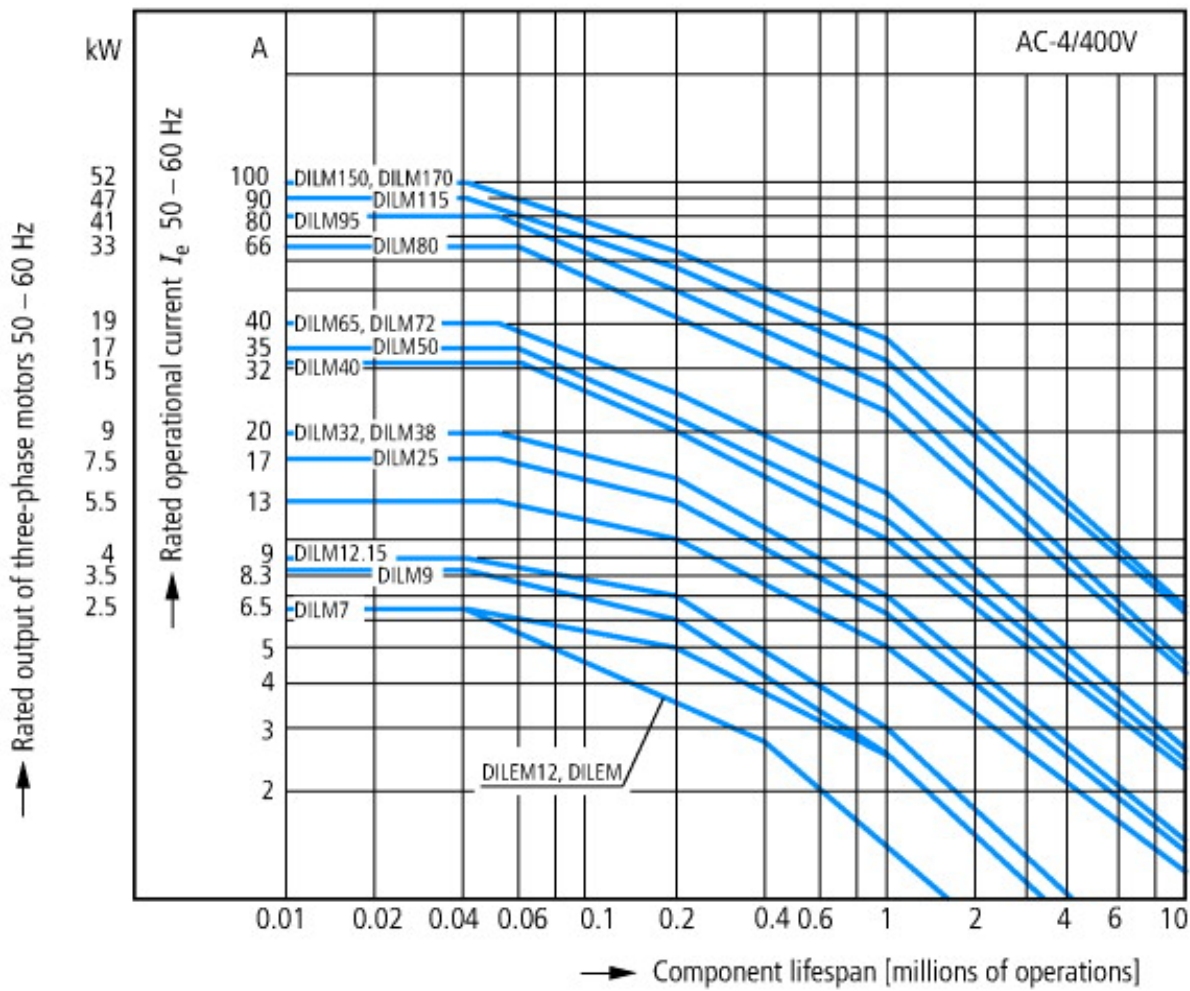

Extreme switching duty  
 Squirrel-cage motor  
 Operating characteristics  
 Inching, plugging, reversing  
 Electrical characteristics  
 Make: up to 6 x rated motor current  
 Break: up to 6 x rated motor current  
 Utilization category  
 100 % AC-4  
 Typical applications  
 Printing presses  
 Wire-drawing machines  
 Centrifuges  
 Special drives for manufacturing and processing machines



Switching conditions for non-motor consumers, 3 pole, 4 pole  
 Operating characteristics  
 Non inductive and slightly inductive loads  
 Electrical characteristics  
 Switch on: 1 x rated operational current  
 Switch off: 1 x rated operational current  
 Utilization category  
 100 % AC-1  
 Typical examples of application  
 Electric heat

## Dimensions

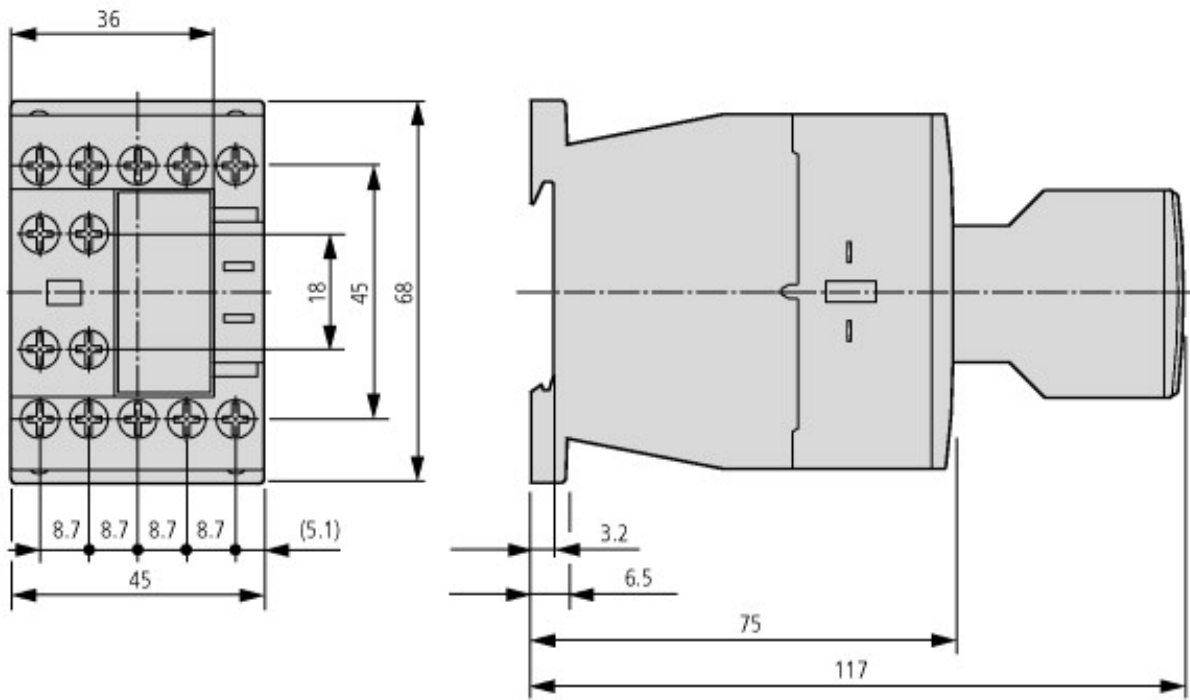

Contacteur with auxiliary contact module

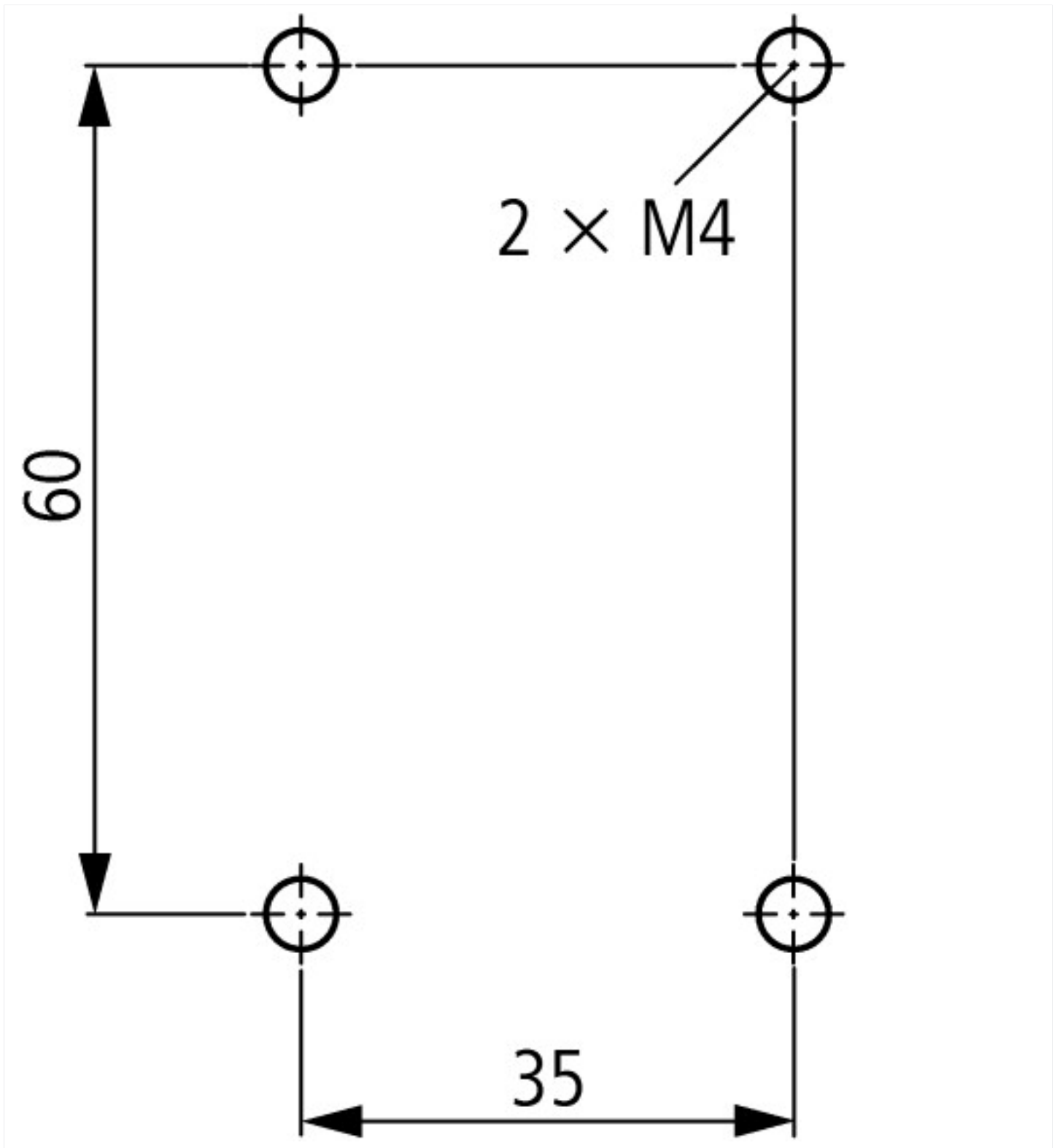

### Additional product information (links)

#### IL03407013Z (AWA2100-2126) Contactors

IL03407013Z (AWA2100-2126) Contactors	<a href="ftp://ftp.moeller.net/DOCUMENTATION/AWA_INSTRUCTIONS/IL03407013Z2012_03.pdf">ftp://ftp.moeller.net/DOCUMENTATION/AWA_INSTRUCTIONS/IL03407013Z2012_03.pdf</a>
UL/CSA: Approved rating data	<a href="http://de.ecat.moeller.net/flip-cat/?edition=HPLTE&amp;startpage=5.84">http://de.ecat.moeller.net/flip-cat/?edition=HPLTE&amp;startpage=5.84</a>
UL/CSA: UL/CSA: Special Purpose Rating	<a href="http://de.ecat.moeller.net/flip-cat/?edition=HPLTE&amp;startpage=5.85">http://de.ecat.moeller.net/flip-cat/?edition=HPLTE&amp;startpage=5.85</a>
UL/CSA: UL/CSA: Short Circuit Current Rating (SCCR)	<a href="http://de.ecat.moeller.net/flip-cat/?edition=HPLTE&amp;startpage=5.86">http://de.ecat.moeller.net/flip-cat/?edition=HPLTE&amp;startpage=5.86</a>
Switchgear of Power Factor Correction Systems	<a href="http://www.moeller.net/binary/ver_techpapers/ver934en.pdf">http://www.moeller.net/binary/ver_techpapers/ver934en.pdf</a>
X-Start - Modern Switching Installations Efficiently Fitted and Wired Securely	<a href="http://www.moeller.net/binary/ver_techpapers/ver938en.pdf">http://www.moeller.net/binary/ver_techpapers/ver938en.pdf</a>
Mirror Contacts for Highly-Reliable Information Relating to Safety-Related Control Functions	<a href="http://www.moeller.net/binary/ver_techpapers/ver944en.pdf">http://www.moeller.net/binary/ver_techpapers/ver944en.pdf</a>
Effect of the Cable Capacitance of Long Control Cables on the Actuation of Contactors	<a href="http://www.moeller.net/binary/ver_techpapers/ver949en.pdf">http://www.moeller.net/binary/ver_techpapers/ver949en.pdf</a>

Motor starters and "Special Purpose Ratings" for the North American market	<a href="http://www.moeller.net/binary/ver_techpapers/ver953en.pdf">http://www.moeller.net/binary/ver_techpapers/ver953en.pdf</a>
Switchgear for Luminaires	<a href="http://www.moeller.net/binary/ver_techpapers/ver955en.pdf">http://www.moeller.net/binary/ver_techpapers/ver955en.pdf</a>
Standard Compliant and Functionally Safe Engineering Design with Mechanical Auxiliary Contacts	<a href="http://www.moeller.net/binary/ver_techpapers/ver956en.pdf">http://www.moeller.net/binary/ver_techpapers/ver956en.pdf</a>
The Interaction of Contactors with PLCs	<a href="http://www.moeller.net/binary/ver_techpapers/ver957en.pdf">http://www.moeller.net/binary/ver_techpapers/ver957en.pdf</a>
Busbar Component Adapters for modern Industrial control panels	<a href="http://www.moeller.net/binary/ver_techpapers/ver960en.pdf">http://www.moeller.net/binary/ver_techpapers/ver960en.pdf</a>