



Contactor, 3p, 55kW/400V/AC3

Part no. DILM115(RDC130)
Article no. 239567
Catalog No. XTCE115G00AD

Delivery program

Product range			Contactors
Application			Contactors for Motors
Subrange			Contactors up to 170 A, 3 pole
Utilization category			AC-1: Non-inductive or slightly inductive loads, resistance furnaces NAC-3: Normal AC induction motors: starting, switch off during running AC-4: Normal AC induction motors: starting, plugging, reversing, inching
Notes			Also suitable for motors with efficiency class IE3. IE3-ready devices are identified by the logo on their packaging.
Connection technique			Screw terminals
Number of poles			3 pole
Rated operational current			
AC-3			
380 V 400 V	I_e	A	115
AC-1			
Conventional free air thermal current, 3 pole, 50 - 60 Hz			
Open			
at 40 °C	$I_{th} = I_e$	A	160
enclosed	I_{th}	A	115
Conventional free air thermal current, 1 pole			
open	I_{th}	A	325
enclosed	I_{th}	A	285
Max. rating for three-phase motors, 50 - 60 Hz			
AC-3			
220 V 230 V	P	kW	37
380 V 400 V	P	kW	55
660 V 690 V	P	kW	90
AC-4			
220 V 230 V	P	kW	17
380 V 400 V	P	kW	28
660 V 690 V	P	kW	43
Contact sequence			
Instructions			Contacts to EN 50012. integrated suppressor circuit in actuating electronics
Can be combined with auxiliary contact			DILM150-XHI(V).. DILM1000-XHI(V)..
Voltage AC/DC			DC operation

Technical data

General			
Standards			IEC/EN 60947, VDE 0660, UL, CSA
Lifespan, mechanical			
AC operated	Operations	$\times 10^6$	10

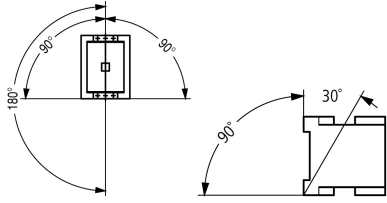
DC operated	Operations	x 10 ⁶	10
Operating frequency, mechanical			
AC operated	Operations/h		3600
DC operated	Operations/h		3600
Climatic proofing			
			Damp heat, constant, to IEC 60068-2-78 Damp heat, cyclic, to IEC 60068-2-30
Ambient temperature			
Open		°C	-25 - +60
Enclosed		°C	- 25 - 40
Storage		°C	- 40 - 80
Mounting position			
			
Mechanical shock resistance (IEC/EN 60068-2-27)			
Half-sinusoidal shock, 10 ms			
Main contacts			
N/O contact		g	10
Auxiliary contacts			
N/O contact		g	7
N/C contact		g	5
Mechanical shock resistance (IEC/EN 60068-2-27) when tabletop-mounted			
Half-sinusoidal shock, 10 ms			
Main contacts			
N/O contact		g	10
Auxiliary contacts			
N/O contact		g	7
N/C contact		g	5
Degree of Protection			
			IP00
Protection against direct contact when actuated from front (EN 50274)			
			Finger and back-of-hand proof
Weight			
AC operated		kg	2
DC operated		kg	2.1
Terminal capacity main cable			
Flexible with ferrule		mm ²	1 x (10 - 95) 2 x (10 - 70)
Stranded		mm ²	1 x (16 - 95) 2 x (16 - 70)
Solid or stranded		AWG	8...3/0
Flat conductor	Lamellenzahl x Breite x Dicke	mm	2 x (6 x 16 x 0.8)
Main cable connection screw/bolt			
			M10
Tightening torque			
			Nm 14
Terminal capacity control circuit cables			
Solid		mm ²	1 x (0.75 - 4) 2 x (0.75 - 4)
Flexible with ferrule		mm ²	1 x (0.75 - 2.5) 2 x (0.75 - 2.5)
Solid or stranded		AWG	18 - 14
Control circuit cable connection screw/bolt			
			M3.5
Tightening torque			
			Nm 1.2
Tool			
Main cable			
Hexagon socket-head spanner	SW	mm	5
Control circuit cables			

Pozidriv screwdriver	Size	2
Standard screwdriver	mm	0.8 x 5.5 1 x 6

Main conducting paths

Rated impulse withstand voltage	U_{imp}	V AC	8000
Overvoltage category/pollution degree			III/3
Rated insulation voltage	U_i	V AC	690
Rated operational voltage	U_e	V AC	690
Safe isolation to EN 61140			
between coil and contacts		V AC	690
between the contacts		V AC	690
Making capacity (p.f. to IEC/EN 60947)			
	U_p to 690 V	A	1610
Breaking capacity			
220 V 230 V		A	1150
380 V 400 V		A	1150
500 V		A	1150
660 V 690 V		A	1100
Short-circuit rating			
Short-circuit protection maximum fuse			
Type "2" coordination			
400 V	gG/gL 500 V	A	250
690 V	gG/gL 690 V	A	250
Type "1" coordination			
400 V	gG/gL 500 V	A	250
690 V	gG/gL 690 V	A	250

AC

AC-1			
Rated operational current			
Conventional free air thermal current, 3 pole, 50 - 60 Hz			
Open			
at 40 °C	$I_{th} = I_e$	A	160
at 50 °C	$I_{th} = I_e$	A	142
at 55 °C	$I_{th} = I_e$	A	135
at 60 °C	$I_{th} = I_e$	A	130
enclosed	I_{th}	A	115
Conventional free air thermal current, 1 pole			
open	I_{th}	A	325
enclosed	I_{th}	A	285
AC-3			
Rated operational current			
Open, 3-pole: 50 – 60 Hz			
220 V 230 V	I_e	A	115
240 V	I_e	A	115
380 V 400 V	I_e	A	115
415 V	I_e	A	115
440V	I_e	A	115
500 V	I_e	A	115
660 V 690 V	I_e	A	93
380 V 400 V	I_e	A	115
Motor rating	P	kWh	
220 V 230 V	P	kW	37
240V	P	kW	40
380 V 400 V	P	kW	55
415 V	P	kW	70

440 V	P	kW	75
500 V	P	kW	85
660 V 690 V	P	kW	90
AC-4			
Open, 3-pole: 50 – 60 Hz			
220 V 230 V	I _e	A	55
240 V	I _e	A	55
380 V 400 V	I _e	A	55
415 V	I _e	A	55
440 V	I _e	A	55
500 V	I _e	A	55
660 V 690 V	I _e	A	45
Motor rating			
220 V 230 V	P	kW	17
240 V	P	kW	19
380 V 400 V	P	kW	28
415 V	P	kW	33
440 V	P	kW	35
500 V	P	kW	40
660 V 690 V	P	kW	43

DC

Rated operational current, open			
DC-1			
60 V	I _e	A	160
110 V	I _e	A	160
220 V	I _e	A	90
440 V	I _e	A	4.5
DC-3			
60 V	I _e	A	160
110 V	I _e	A	160
220 V	I _e	A	40
440 V	I _e	A	1
DC-5			
60 V	I _e	A	160
110 V	I _e	A	160
220 V	I _e	A	40
440 V	I _e	A	1

Current heat loss

3-pole at I _{th}	W	25.8
Current heat loss at I _e to AC-3/400 V	W	18.9
Impedance per pole	mΩ	0.6

Magnet systems

Voltage tolerance			
AC operated	Pick-up	x U _c	0.8 - 1.15
Drop-out voltage AC operated	Drop-out	x U _c	0.25 - 0.6
DC operated	Pick-up	x U _c	0.7 - 1.2
Notes			RDC 130 (U _{min} 110 V DC/U _{max} 130 V DC) Example: U _c = 0.7 x U _{min} - 1.2 x U _{max} / U _c = 0.7 x 110 V - 1.2 x 130 V DC
DC operated	Drop-out	x U _c	0.15 - 0.6
Notes			at least smoothed two-phase bridge rectifier or three-phase rectifier
Power consumption of the coil in a cold state and 1.0 x U _c			
50 Hz	Pick-up	VA	180
50 Hz	Sealing	VA	3.1
50 Hz	Sealing	W	2.1

60 Hz	Pick-up	VA	170
60 Hz	Sealing	VA	3.1
60 Hz	Sealing	W	2.1
50/60 Hz	Pick-up	VA	170 170
50/60 Hz	Sealing	VA	3.1 3.1
50/60 Hz	Sealing	W	2.1
DC operated	Pick-up	W	149
DC operated	Sealing	W	2.1
Duty factor		% DF	100
Changeover time at 100 % U _C (recommended value)			
Main contacts			
AC operated			
Closing delay		ms	28 - 33
Opening delay		ms	35 - 41
DC operated			
Closing delay		ms	35
Opening delay		ms	30
Arcing time			
		ms	15
Permissible residual current with actuation of A1 - A2 by the electronics (with 0 signal).		mA	≤ 1
Lifespan, mechanical; Coil 50/60 Hz		x 10 ⁶	Mechanical lifespan at 50 Hz approx. 30% lower than under "Technical data, general"

Electromagnetic compatibility (EMC)

Emitted interference			to EN 60947-1
Interference immunity			to EN 60947-1

Design verification as per IEC/EN 61439

Technical data for design verification			
Rated operational current for specified heat dissipation	I _n	A	115
Heat dissipation per pole, current-dependent	P _{vid}	W	6.3
Equipment heat dissipation, current-dependent	P _{vid}	W	18.9
Static heat dissipation, non-current-dependent	P _{vs}	W	1.9
Heat dissipation capacity	P _{diss}	W	0
Operating ambient temperature min.		°C	-25
Operating ambient temperature max.		°C	60
IEC/EN 61439 design verification			
10.2 Strength of materials and parts			
10.2.2 Corrosion resistance			
			Meets the product standard's requirements.
10.2.3.1 Verification of thermal stability of enclosures			
			Meets the product standard's requirements.
10.2.3.2 Verification of resistance of insulating materials to normal heat			
			Meets the product standard's requirements.
10.2.3.3 Verification of resistance of insulating materials to abnormal heat and fire due to internal electric effects			
			Meets the product standard's requirements.
10.2.4 Resistance to ultra-violet (UV) radiation			
			Meets the product standard's requirements.
10.2.5 Lifting			
			Does not apply, since the entire switchgear needs to be evaluated.
10.2.6 Mechanical impact			
			Does not apply, since the entire switchgear needs to be evaluated.
10.2.7 Inscriptions			
			Meets the product standard's requirements.
10.3 Degree of protection of ASSEMBLIES			
			Does not apply, since the entire switchgear needs to be evaluated.
10.4 Clearances and creepage distances			
			Meets the product standard's requirements.
10.5 Protection against electric shock			
			Does not apply, since the entire switchgear needs to be evaluated.
10.6 Incorporation of switching devices and components			
			Does not apply, since the entire switchgear needs to be evaluated.
10.7 Internal electrical circuits and connections			
			Is the panel builder's responsibility.
10.8 Connections for external conductors			
			Is the panel builder's responsibility.
10.9 Insulation properties			
10.9.2 Power-frequency electric strength			
			Is the panel builder's responsibility.
10.9.3 Impulse withstand voltage			
			Is the panel builder's responsibility.

10.9.4 Testing of enclosures made of insulating material		Is the panel builder's responsibility.
10.10 Temperature rise		The panel builder is responsible for the temperature rise calculation. Eaton will provide heat dissipation data for the devices.
10.11 Short-circuit rating		Is the panel builder's responsibility. The specifications for the switchgear must be observed.
10.12 Electromagnetic compatibility		Is the panel builder's responsibility. The specifications for the switchgear must be observed.
10.13 Mechanical function		The device meets the requirements, provided the information in the instruction leaflet (IL) is observed.

Technical data ETIM 6.0

Low-voltage industrial components (EG000017) / Power contactor, AC switching (EC000066)		
Electric engineering, automation, process control engineering / Low-voltage switch technology / Contactor (LV) / Power contactor, AC switching (ecl@ss8.1-27-37-10-03 [AAB718012])		
Rated control supply voltage Us at AC 50HZ	V	0 - 0
Rated control supply voltage Us at AC 60HZ	V	0 - 0
Rated control supply voltage Us at DC	V	110 - 130
Voltage type for actuating		DC
Rated operation current Ie at AC-1, 400 V	A	160
Rated operation current Ie at AC-3, 400 V	A	115
Rated operation power at AC-3, 400 V	kW	55
Rated operation current Ie at AC-4, 400 V	A	55
Rated operation power Ie at AC-4, 400 V	kW	28
Modular version		No
Number of auxiliary contacts as normally open contact		0
Number of auxiliary contacts as normally closed contact		0
Type of electrical connection of main circuit		Screw connection
Number of normally closed contacts as main contact		0
Number of main contacts as normally open contact		3

Approvals

Product Standards		IEC/EN 60947-4-1; UL 508; CSA-C22.2 No. 14-05; CE marking
UL File No.		E29096
UL Category Control No.		NLDX
CSA File No.		012528
CSA Class No.		2411-03, 3211-04
North America Certification		UL listed, CSA certified
Specially designed for North America		No

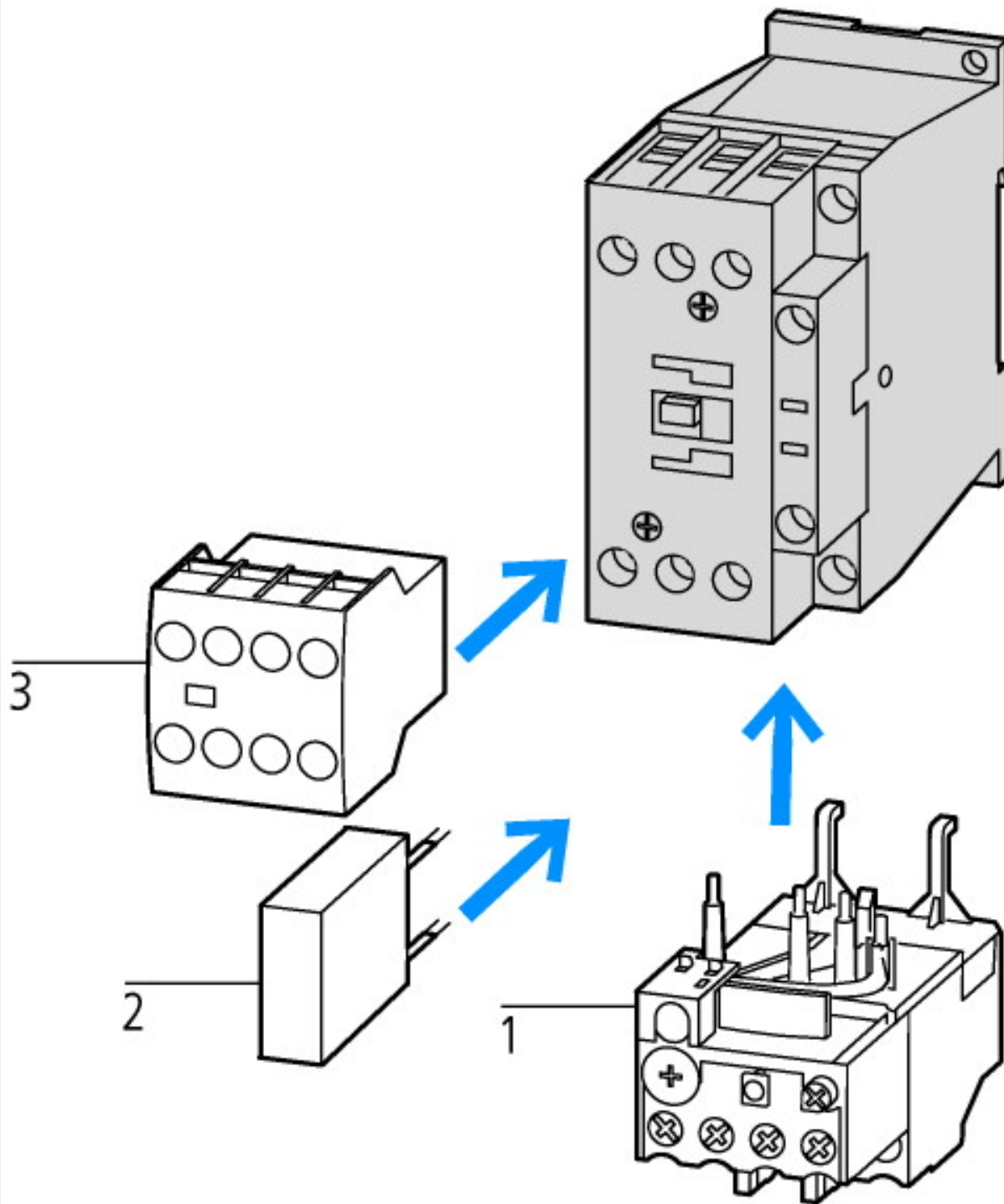

- 1: Overload relay
- 2: Suppressor
- 3: Auxiliary contact modules

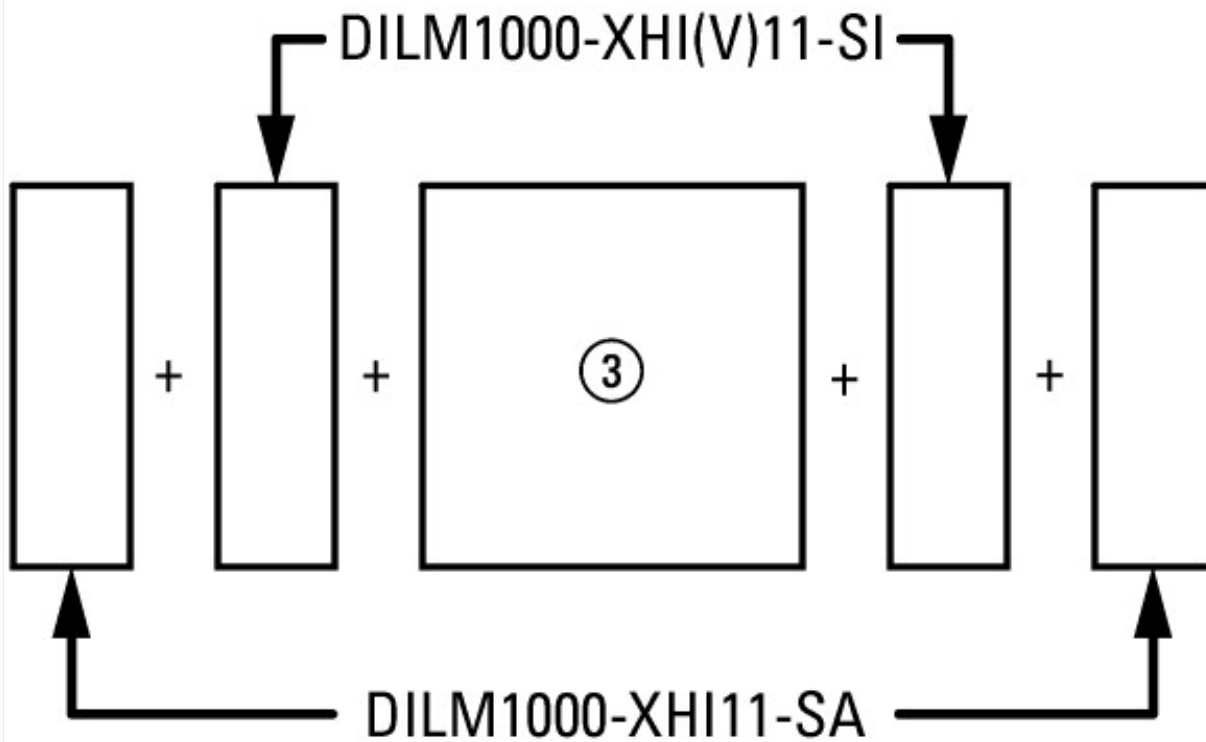

on the side: 2 x DILM820-XHI11(V)-SI; 2 x DILM820-XHI11-SA

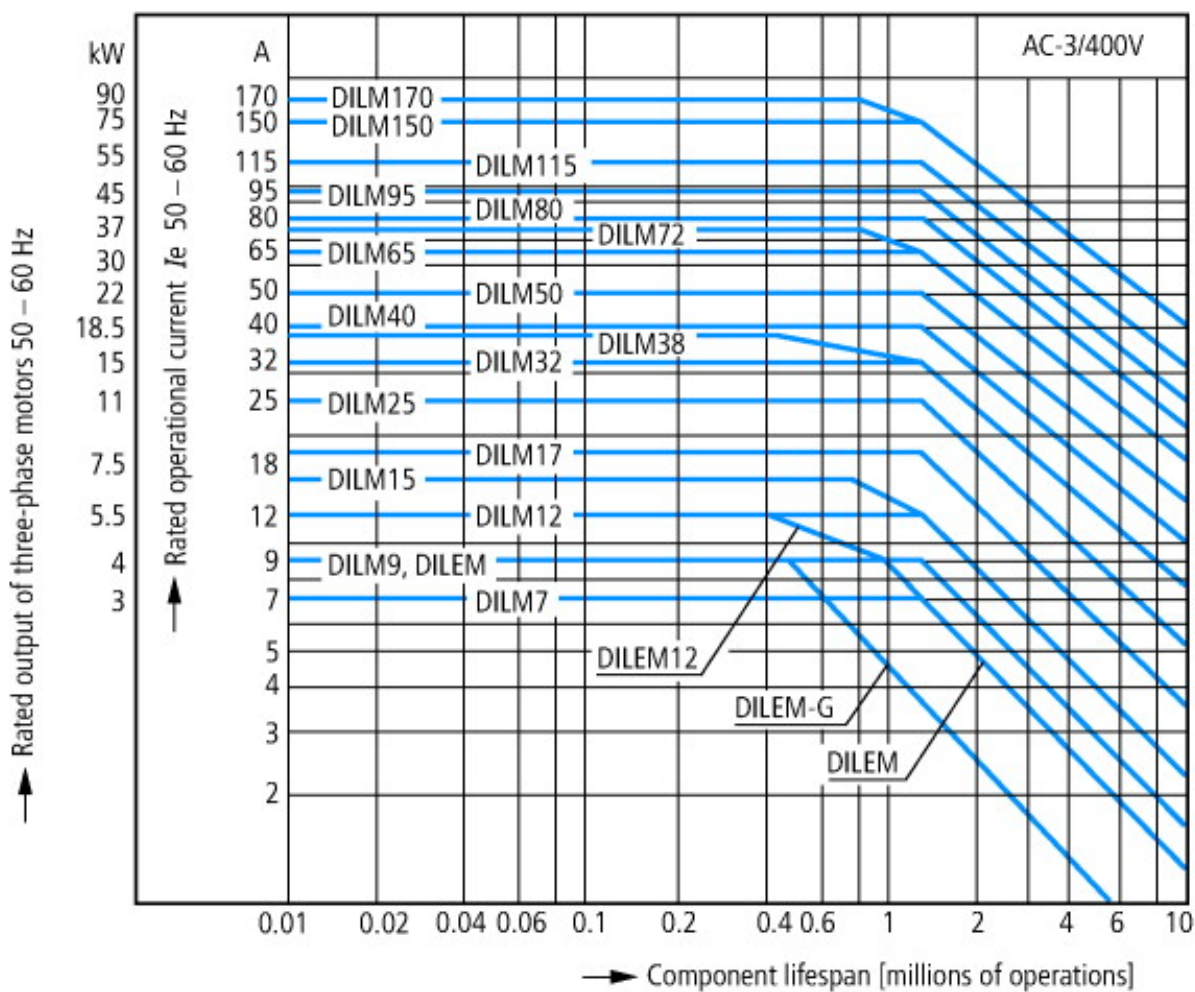

Squirrel-cage motor
 Operating characteristics
 Starting: from rest
 Stopping: after attaining full running speed
 Electrical characteristics
 Make: up to 6 x rated motor current
 Break: up to 1 x rated motor current
 Utilization category
 100 % AC-3
 Typical applications

- Compressors
- Lifts
- Mixers
- Pumps
- Escalators
- Agitators
- Fans
- Conveyor belts
- Centrifuges
- Hinged flaps
- Bucket-elevators
- Air conditioning system
- General drives in manufacturing and processing machines

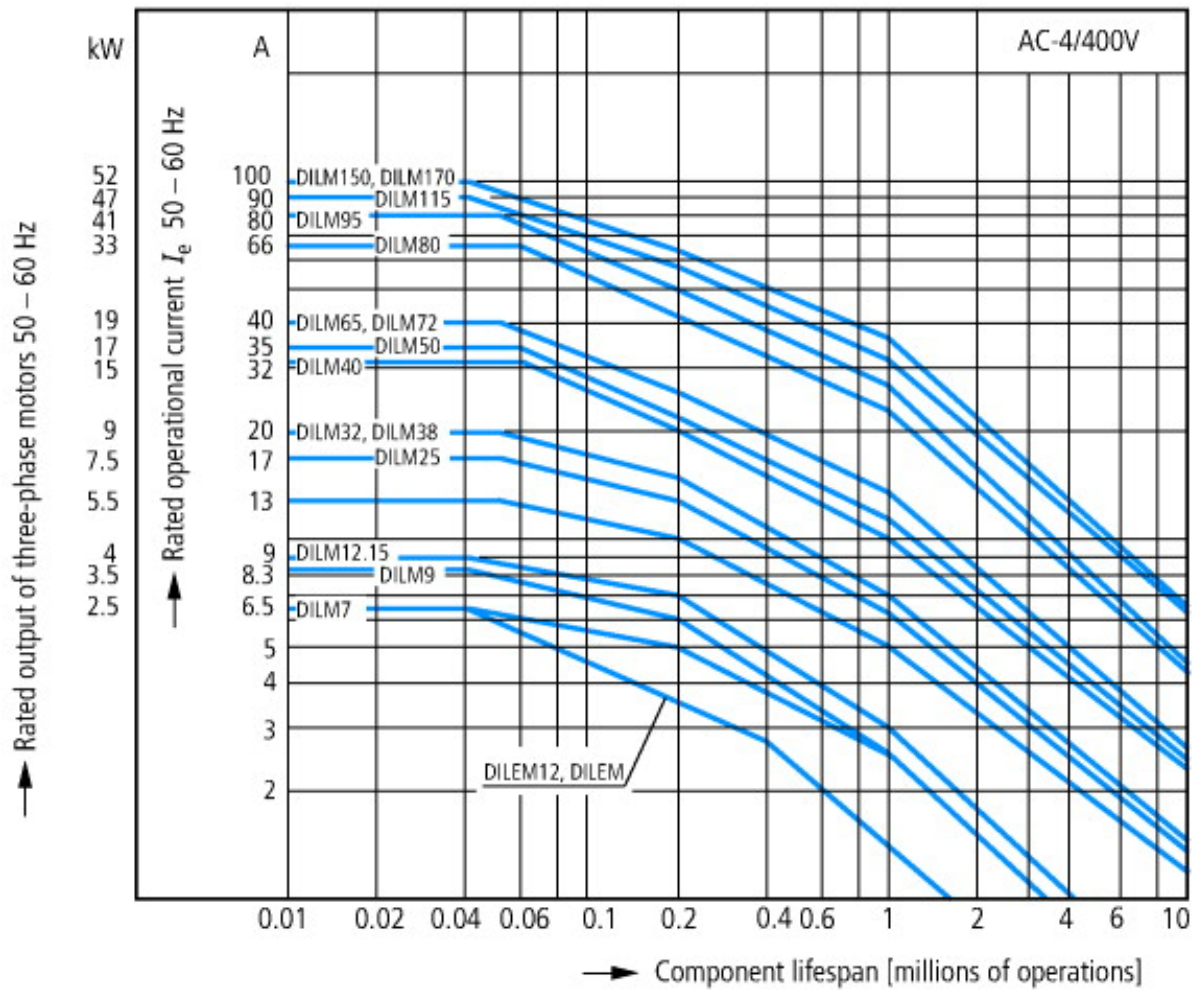

- Extreme switching duty
- Squirrel-cage motor
- Operating characteristics
- Inching, plugging, reversing
- Electrical characteristics
- Make: up to 6 x rated motor current
- Break: up to 6 x rated motor current
- Utilization category
- 100 % AC-4
- Typical applications
- Printing presses
- Wire-drawing machines
- Centrifuges
- Special drives for manufacturing and processing machines

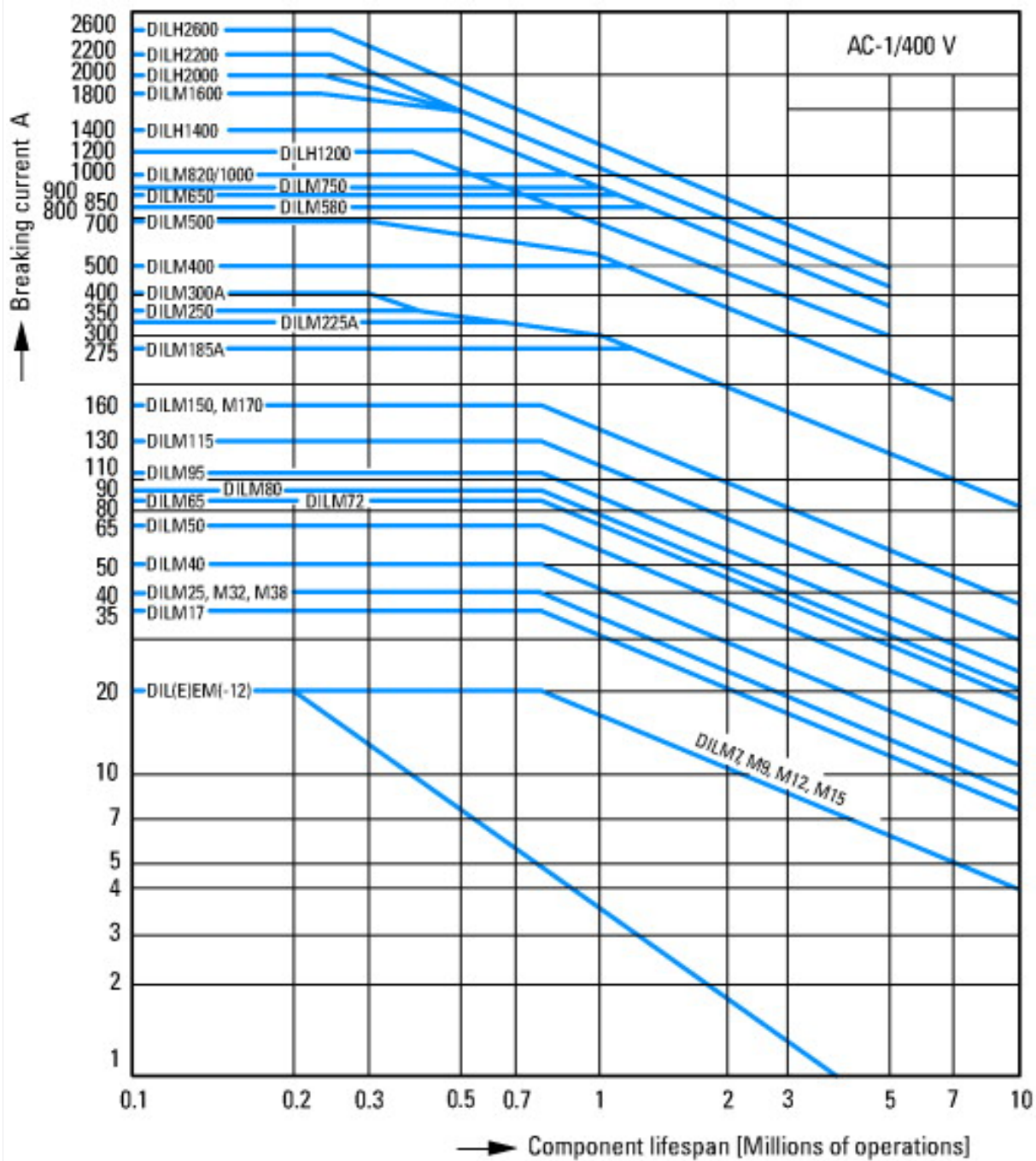

Switching conditions for non-motor consumers, 3 pole, 4 pole
 Operating characteristics
 Non inductive and slightly inductive loads
 Electrical characteristics
 Switch on: 1 x rated operational current
 Switch off: 1 x rated operational current
 Utilization category
 100 % AC-1
 Typical examples of application
 Electric heat

Dimensions

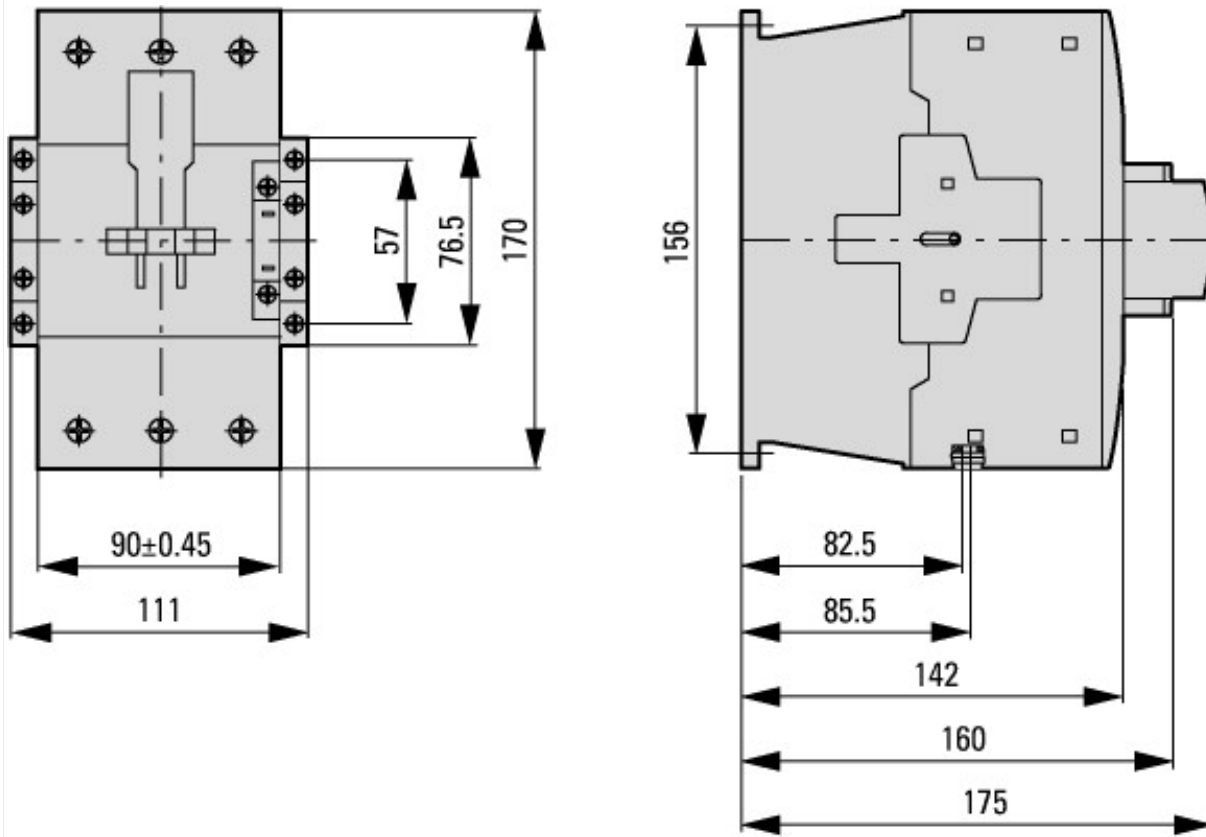

Contacteur avec module de contact auxiliaire

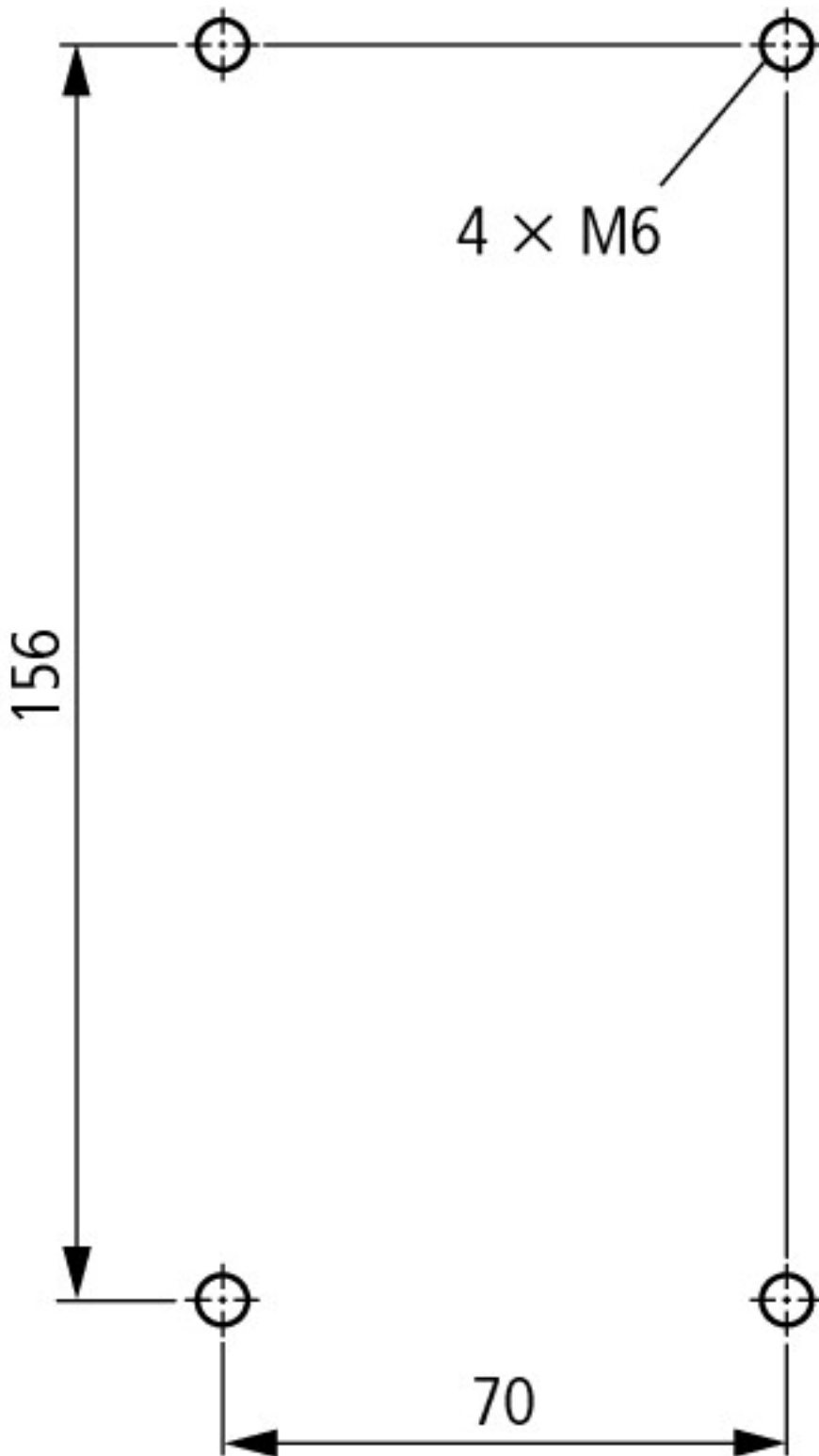

distance at side to earthed parts: 10 mm

DILM80...DILM170
 DILMC80...DILMC150
 DILMF80...DILMF150

Additional product information (links)

IL03407039Z (AWA2100-2286) Contactors

IL03407039Z (AWA2100-2286) Contactors	ftp://ftp.moeller.net/DOCUMENTATION/AWA_INSTRUCTIONS/IL03407039Z2010_10.pdf
UL/CSA: Approved rating data	http://de.ecat.moeller.net/flip-cat/?edition=HPLTE&startpage=5.84
UL/CSA: UL/CSA: Special Purpose Rating	http://de.ecat.moeller.net/flip-cat/?edition=HPLTE&startpage=5.85
UL/CSA: UL/CSA: Short Circuit Current Rating (SCCR)	http://de.ecat.moeller.net/flip-cat/?edition=HPLTE&startpage=5.86
Switchgear of Power Factor Correction Systems	http://www.moeller.net/binary/ver_techpapers/ver934en.pdf
X-Start - Modern Switching Installations Efficiently Fitted and Wired Securely	http://www.moeller.net/binary/ver_techpapers/ver938en.pdf

Mirror Contacts for Highly-Reliable Information Relating to Safety-Related Control Functions	http://www.moeller.net/binary/ver_techpapers/ver944en.pdf
Effect of the Cabel Capacitance of Long Control Cables on the Actuation of Contactors	http://www.moeller.net/binary/ver_techpapers/ver949en.pdf
Motor starters and "Special Purpose Ratings" for the North American market	http://www.moeller.net/binary/ver_techpapers/ver953en.pdf
Switchgear for Luminaires	http://www.moeller.net/binary/ver_techpapers/ver955en.pdf
Standard Compliant and Functionally Safe Engineering Design with Mechanical Auxiliary Contacts	http://www.moeller.net/binary/ver_techpapers/ver956en.pdf
The Interaction of Contactors with PLCs	http://www.moeller.net/binary/ver_techpapers/ver957en.pdf
Busbar Component Adapters for modern Industrial control panels	http://www.moeller.net/binary/ver_techpapers/ver960en.pdf