



**Contactor, 3p+1N/O, 3kW/400V/AC3**

**Part no. DILEEM-10(380V50HZ,440V60HZ)**  
**Article no. 051607**  
**Catalog No. XTMC6A10L**

## Delivery program

Product range			Contactors
Application			Mini Contactors for Motors and Resistive Loads
Subrange			Contactors DILEEM
Utilization category			AC-1: Non-inductive or slightly inductive loads, resistance furnaces NAC-3: Normal AC induction motors: starting, switch off during running AC-4: Normal AC induction motors: starting, plugging, reversing, inching
Notes			Also suitable for motors with efficiency class IE3. IE3-ready devices are identified by the logo on their packaging.
Connection technique			Screw terminals
Description			With auxiliary contact
Number of poles			3 pole
<b>Rated operational current</b>			
AC-3			
380 V 400 V	$I_e$	A	6.6
AC-1			
Conventional free air thermal current, 3 pole, 50 - 60 Hz			
Open			
at 40 °C	$I_{th} = I_e$	A	22
<b>Max. rating for three-phase motors, 50 - 60 Hz</b>			
AC-3			
220 V 230 V	P	kW	1.5
380 V 400 V	P	kW	3
660 V 690 V	P	kW	3
AC-4			
220 V 230 V	P	kW	1.1
380 V 400 V	P	kW	2.2
660 V 690 V	P	kW	2.2
<b>Contacts</b>			
N/O = Normally open			1 N/O
Contact sequence			
For use with			...DILEM ...DILE
Actuating voltage			380 V 50 Hz, 440 V 60 Hz
Voltage AC/DC			AC operation

## Technical data

<b>General</b>			
Standards			IEC/EN 60947, VDE 0660, CSA, UL
Lifespan, mechanical; Coil 50/60 Hz	Operations	$\times 10^6$	7
Lifespan, mechanical	Operations	$\times 10^6$	10
Maximum operating frequency			
Mechanical		Ops./h	9000
electrical (Contactors without overload relay)	Operations/h		Page 05/070
Climatic proofing			Damp heat, constant, to IEC 60068-2-78

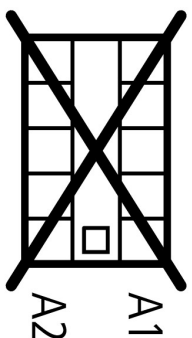
			Damp heat, cyclic, to IEC 60068-2-30
<b>Ambient temperature</b>			
Open		°C	-25 - +50
Enclosed		°C	- 25 - 40
<b>Mounting position</b>			
Mounting position			As required, except vertical with terminals A1/A2 at the bottom
			
<b>Mechanical shock resistance (IEC/EN 60068-2-27)</b>			
Half-sinusoidal shock, 10 ms			
Basic unit without auxiliary contact module			
Main contacts, make contacts		g	10
Main contacts Make/break contacts		g	10 / 8
Basic unit with auxiliary contact module			
Main contacts make contact		g	
Make		g	10
Auxiliary contacts Make/break contacts		g	20 / 20
<b>Degree of Protection</b>			
IP20			
<b>Protection against direct contact when actuated from front (EN 50274)</b>			
Finger and back-of-hand proof			
<b>Weight</b>			
		kg	0.2
<b>Terminal capacity of auxiliary and main contacts</b>			
Screw terminals			
Solid		mm <sup>2</sup>	1 x (0.75 - 2.5) 2 x (0.75 - 2.5)
Flexible with ferrule		mm <sup>2</sup>	1 x (0.75 - 1.5) 2 x (0.75 - 1.5)
Solid or stranded		AWG	18 - 14
Terminal screw			M3.5
Pozidriv screwdriver		Size	2
Standard screwdriver		mm	0.8 x 5.5 1 x 6
Max. tightening torque		Nm	1.2
<b>Main conducting paths</b>			
Rated impulse withstand voltage	U <sub>imp</sub>	V AC	6000
Overvoltage category/pollution degree			III/3
Rated insulation voltage	U <sub>i</sub>	V AC	690
Rated operational voltage	U <sub>e</sub>	V AC	690
<b>Safe isolation to EN 61140</b>			
between coil and contacts		V AC	300
between the contacts		V AC	300
<b>Making capacity (cos φ to IEC/EN 60947)</b>			
		A	110
<b>Breaking capacity</b>			
220 V 230 V		A	90
380 V 400 V		A	90
500 V		A	64
660 V 690 V		A	42
<b>Short-circuit protection maximum fuse</b>			
Type "2" coordination	gL/gG	A	10
Type "1" coordination	gL/gG	A	20

## AC

AC-1			
Rated operational current			
Conventional free air thermal current, 3 pole, 50 - 60 Hz			
Open			
at 40 °C	$I_{th} = I_e$	A	22
at 50 °C	$I_{th} = I_e$	A	20
at 55 °C	$I_{th} = I_e$	A	19
enclosed	$I_{th}$	A	16
Notes			At maximum permissible ambient air temperature.
Conventional free air thermal current, 1 pole			
Notes			At maximum permissible ambient air temperature.
open	$I_{th}$	A	50
enclosed	$I_{th}$	A	40
AC-3			
Rated operational current			
Open, 3-pole: 50 – 60 Hz			
Notes			At maximum permissible ambient air temperature.
220 V 230 V	$I_e$	A	6.6
240 V	$I_e$	A	6.6
380 V 400 V	$I_e$	A	6.6
415 V	$I_e$	A	6.6
440V	$I_e$	A	6.6
500 V	$I_e$	A	5
660 V 690 V	$I_e$	A	3.5
Motor rating		P	kWh
220 V 230 V	P	kW	1.5
240V	P	kW	1.8
380 V 400 V	P	kW	3
415 V	P	kW	3.1
440 V	P	kW	3.3
500 V	P	kW	3
660 V 690 V	P	kW	3
AC-4			
Rated operational current			
Open, 3-pole: 50 – 60 Hz			
Notes			At maximum permissible ambient air temperature.
220 V 230 V	$I_e$	A	5
240 V	$I_e$	A	5
380 V 400 V	$I_e$	A	5
415 V	$I_e$	A	5
440 V	$I_e$	A	5
500 V	$I_e$	A	3.7
660 V 690 V	$I_e$	A	2.9
Motor rating		P	kWh
220 V 230 V	P	kW	1.1
240 V	P	kW	1.3
380 V 400 V	P	kW	2.2
415 V	P	kW	2.3
440 V	P	kW	2.4
500 V	P	kW	2.2
660 V 690 V	P	kW	2.2
DC			
Rated operational current open			

DC-1			
12 V	$I_e$	A	20
24 V	$I_e$	A	20
60 V	$I_e$	A	20
110 V	$I_e$	A	20
220 V	$I_e$	A	20
DC - 3			
12 V	$I_e$	A	6
24 V	$I_e$	A	6
60 V	$I_e$	A	3
110 V	$I_e$	A	2
DC - 5			
12 V	$I_e$	A	1.8
24 V	$I_e$	A	1.8
60 V	$I_e$	A	1.8
110 V	$I_e$	A	1.8
220 V	$I_e$	A	0.2
Current heat losses (3- or 4-pole)			
to $I_{th}$		W	2
at $I_e$ to AC-3/400 V		W	0.5

## Magnet systems

Voltage tolerance			
AC operated			
Single-voltage coil 50 Hz and dual-voltage coil 50 Hz, 60 Hz	Pick-up	$x U_c$	0.8 - 1.1
Dual-frequency coil 50/60 Hz	Pick-up	$x U_c$	0.8 - 1.1
Power consumption			
AC operation			
Single-voltage coil 50 Hz and dual-voltage coil 50 Hz, 60 Hz	Pick-up	VA	25
Single-voltage coil 50 Hz and dual-voltage coil 50 Hz, 60 Hz	Pick-up	W	22
Single-voltage coil 50 Hz and dual-voltage coil 50 Hz, 60 Hz	Sealing	VA	4.6
Single-voltage coil 50 Hz and dual-voltage coil 50 Hz, 60 Hz	Sealing	W	1.3
Dual-frequency coil 50/60 Hz at 50 Hz	Pick-up	VA	30
Dual-frequency coil 50/60 Hz at 50 Hz	Pick-up	W	26
Dual-frequency coil 50/60 Hz at 50 Hz	Sealing	VA	5.4
Dual-frequency coil 50/60 Hz at 50 Hz	Sealing	W	1.6
Dual-frequency coil 50/60 Hz at 60 Hz	Pick-up	VA	29
Dual-frequency coil 50/60 Hz at 60 Hz	Pick-up	W	24
Dual-frequency coil 50/60 Hz at 60 Hz	Sealing	VA	3.9
Dual-frequency coil 50/60 Hz at 60 Hz	Sealing	W	1.1
Duty factor		% DF	100
Switching times at 100 % $U_c$			
Make contact			
Closing delay		ms	
Closing delay min.		ms	14
Closing delay max.		ms	21
Opening delay			
Opening delay min.		ms	8
Opening delay max.		ms	18
Closing delay with top mounting auxiliary contact		ms	max. 45
Reversing contactors			
Changeover time at 110 % $U_c$			
Changeover time min.		ms	16
Changeover time max.		ms	21
Arcing time at 690 V AC		ms	max. 12

Coil			
Lifespan, mechanical; Coil 50/60 Hz		$\times 10^6$	7

### Auxiliary contacts

Positive operating contacts to EN 60947-5-1 appendix L, including auxiliary contact module			Yes
Rated impulse withstand voltage	$U_{imp}$	V AC	6000
Overvoltage category/pollution degree			III/3
Rated insulation voltage	$U_i$	V AC	690
Rated operational voltage	$U_e$	V AC	600
Safe isolation to EN 61140			
between coil and auxiliary contacts		V AC	300
between the auxiliary contacts		V AC	300
Rated operational current			
AC-15			
220 V 240 V	$I_e$	A	6
380 V 415 V	$I_e$	A	3
500 V	$I_e$	A	1.5
DC L/R  15 ms			
Contacts in series:		A	
1	24 V	A	2.5
2	60 V	A	2.5
3	100 V	A	1.5
3	220 V	A	0.5
Conv. thermal current	$I_{th}$	A	10
Control circuit reliability	Failure rate	$\lambda$	$<10^{-8}$ , < one failure at 100 million operations (at $U_e = 24$ V DC, $U_{min} = 17$ V, $I_{min} = 5.4$ mA)
Component lifespan at $U_e = 240$ V			
AC-15	Operations	$\times 10^6$	0.2
DC current			
L/R = 50 ms: 2 contacts in series at $I_e = 0.5$ A	Operations	$\times 10^6$	0.15
Notes			Switch-on and switch-off conditions based on DC-13, time constant as specified
Short-circuit rating without welding			
Maximum overcurrent protective device			
Short-circuit protection only			PKZM0-4
Short-circuit protection maximum fuse			
500 V		A gG/gL	6
500 V		A fast	10
Current heat loss at a load of $I_{th}$ per contact		W	0.3

### Design verification as per IEC/EN 61439

Technical data for design verification			
Rated operational current for specified heat dissipation	$I_n$	A	6.6
Heat dissipation per pole, current-dependent	$P_{vid}$	W	0.2
Equipment heat dissipation, current-dependent	$P_{vid}$	W	0.6
Static heat dissipation, non-current-dependent	$P_{vs}$	W	1.8
Heat dissipation capacity	$P_{diss}$	W	0
Operating ambient temperature min.		°C	-25
Operating ambient temperature max.		°C	50
IEC/EN 61439 design verification			
10.2 Strength of materials and parts			
10.2.2 Corrosion resistance			Meets the product standard's requirements.
10.2.3.1 Verification of thermal stability of enclosures			Meets the product standard's requirements.
10.2.3.2 Verification of resistance of insulating materials to normal heat			Meets the product standard's requirements.

10.2.3.3 Verification of resistance of insulating materials to abnormal heat and fire due to internal electric effects		Meets the product standard's requirements.
10.2.4 Resistance to ultra-violet (UV) radiation		Meets the product standard's requirements.
10.2.5 Lifting		Does not apply, since the entire switchgear needs to be evaluated.
10.2.6 Mechanical impact		Does not apply, since the entire switchgear needs to be evaluated.
10.2.7 Inscriptions		Meets the product standard's requirements.
10.3 Degree of protection of ASSEMBLIES		Does not apply, since the entire switchgear needs to be evaluated.
10.4 Clearances and creepage distances		Meets the product standard's requirements.
10.5 Protection against electric shock		Does not apply, since the entire switchgear needs to be evaluated.
10.6 Incorporation of switching devices and components		Does not apply, since the entire switchgear needs to be evaluated.
10.7 Internal electrical circuits and connections		Is the panel builder's responsibility.
10.8 Connections for external conductors		Is the panel builder's responsibility.
10.9 Insulation properties		
10.9.2 Power-frequency electric strength		Is the panel builder's responsibility.
10.9.3 Impulse withstand voltage		Is the panel builder's responsibility.
10.9.4 Testing of enclosures made of insulating material		Is the panel builder's responsibility.
10.10 Temperature rise		The panel builder is responsible for the temperature rise calculation. Eaton will provide heat dissipation data for the devices.
10.11 Short-circuit rating		Is the panel builder's responsibility. The specifications for the switchgear must be observed.
10.12 Electromagnetic compatibility		Is the panel builder's responsibility. The specifications for the switchgear must be observed.
10.13 Mechanical function		The device meets the requirements, provided the information in the instruction leaflet (IL) is observed.

## Technical data ETIM 6.0

Low-voltage industrial components (EG000017) / Power contactor, AC switching (EC000066)		
Electric engineering, automation, process control engineering / Low-voltage switch technology / Contactor (LV) / Power contactor, AC switching (ecl@ss8.1-27-37-10-03 [AAB718012])		
Rated control supply voltage Us at AC 50HZ	V	380 - 380
Rated control supply voltage Us at AC 60HZ	V	440 - 440
Rated control supply voltage Us at DC	V	0 - 0
Voltage type for actuating		AC
Rated operation current Ie at AC-1, 400 V	A	22
Rated operation current Ie at AC-3, 400 V	A	6.6
Rated operation power at AC-3, 400 V	kW	3
Rated operation current Ie at AC-4, 400 V	A	5
Rated operation power Ie at AC-4, 400 V	kW	2.2
Modular version		No
Number of auxiliary contacts as normally open contact		1
Number of auxiliary contacts as normally closed contact		0
Type of electrical connection of main circuit		Screw connection
Number of normally closed contacts as main contact		0
Number of main contacts as normally open contact		3

## Approvals

Product Standards		IEC/EN 60947-4-1; UL 508; CSA-C22.2 No. 14-05; CE marking
UL File No.		E29096
UL Category Control No.		NLDX
CSA File No.		012528
CSA Class No.		3211-04
North America Certification		UL listed, CSA certified
Specially designed for North America		No

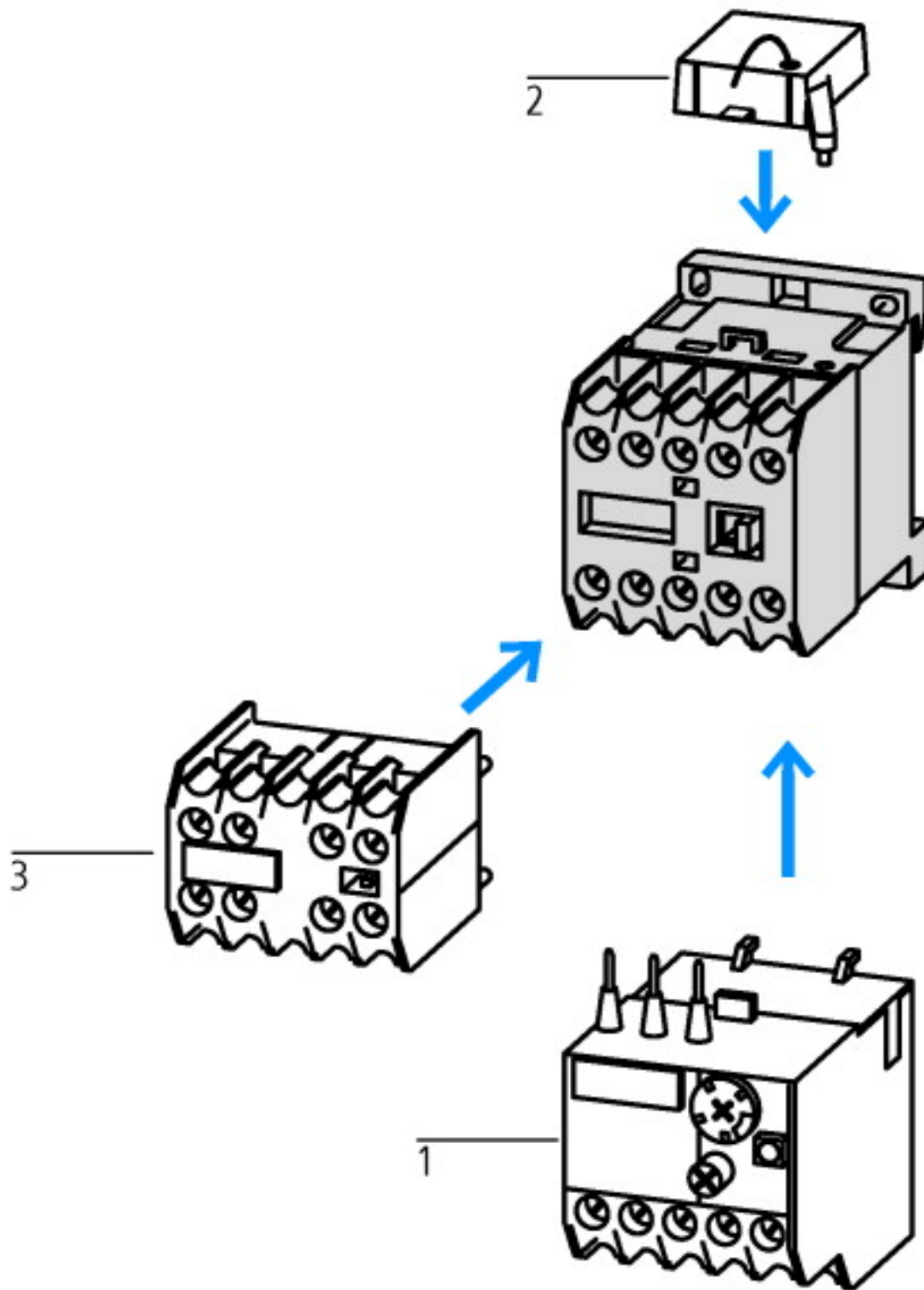

- 1: Overload relay
  - 2: Suppressor
  - 3: Auxiliary contact modules
- Enclosure totally insulated

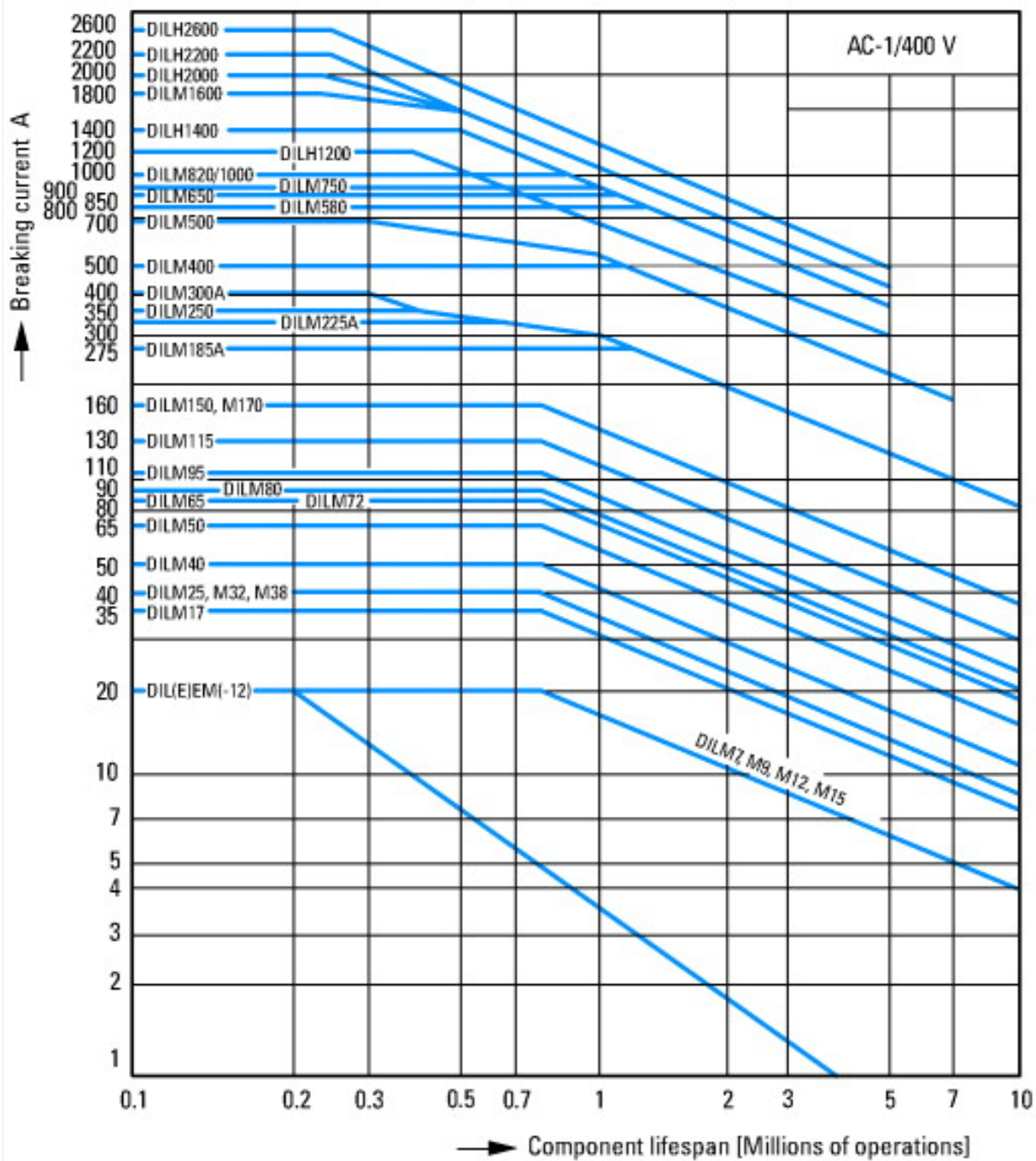

Switching duty for non-motor loads, 3-pole, 4-pole  
 Operating characteristics  
 Non-inductive or slightly inductive loads  
 Electrical characteristics  
 Make: 1 x rated current  
 Break: 1 x rated current  
 Utilization category  
 100 % AC-1  
 Typical applications  
 Electric heat



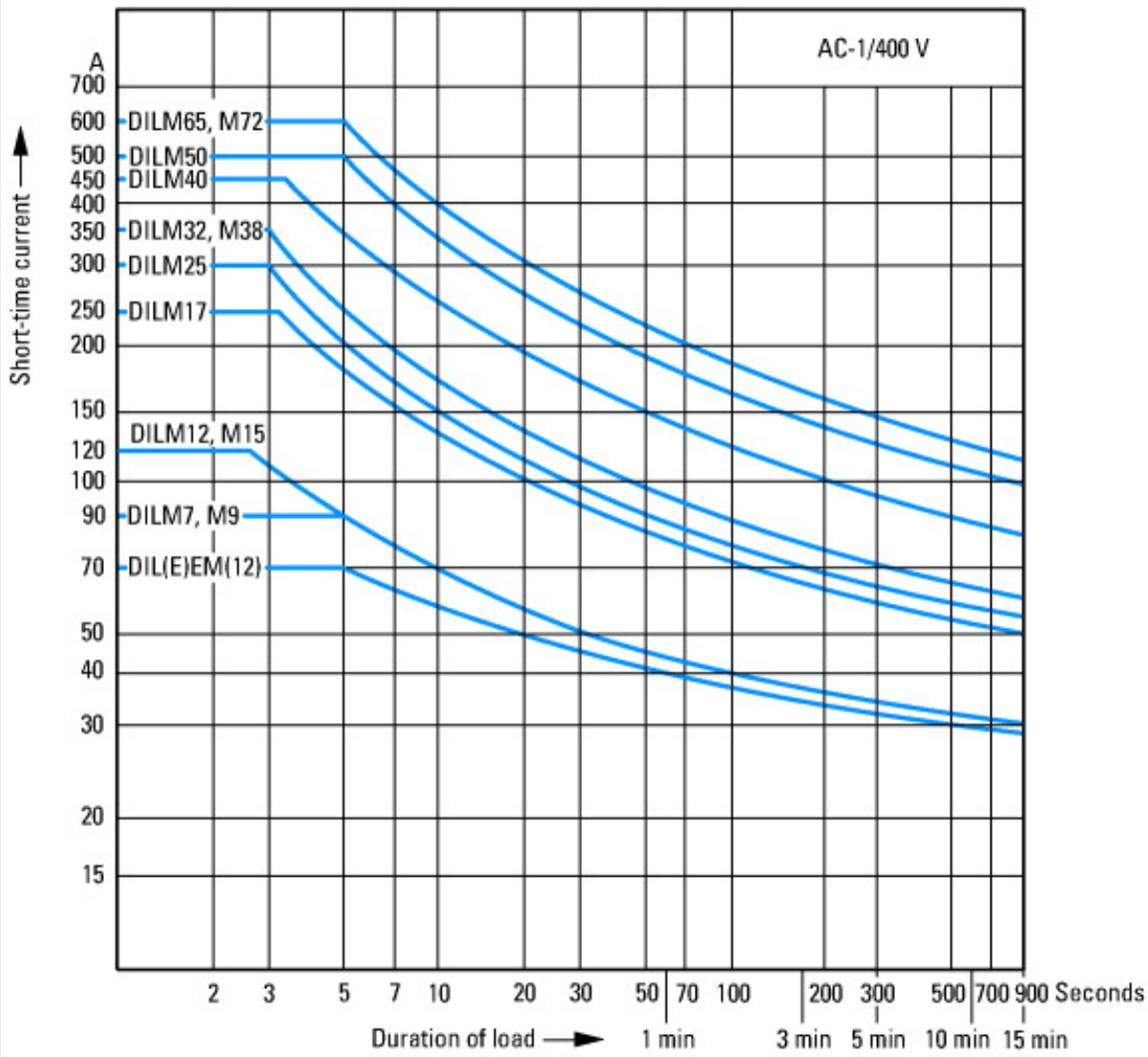

Short-time loading, 3-pole  
 Time interval between two loading cycles: 15 minutes

## Dimensions

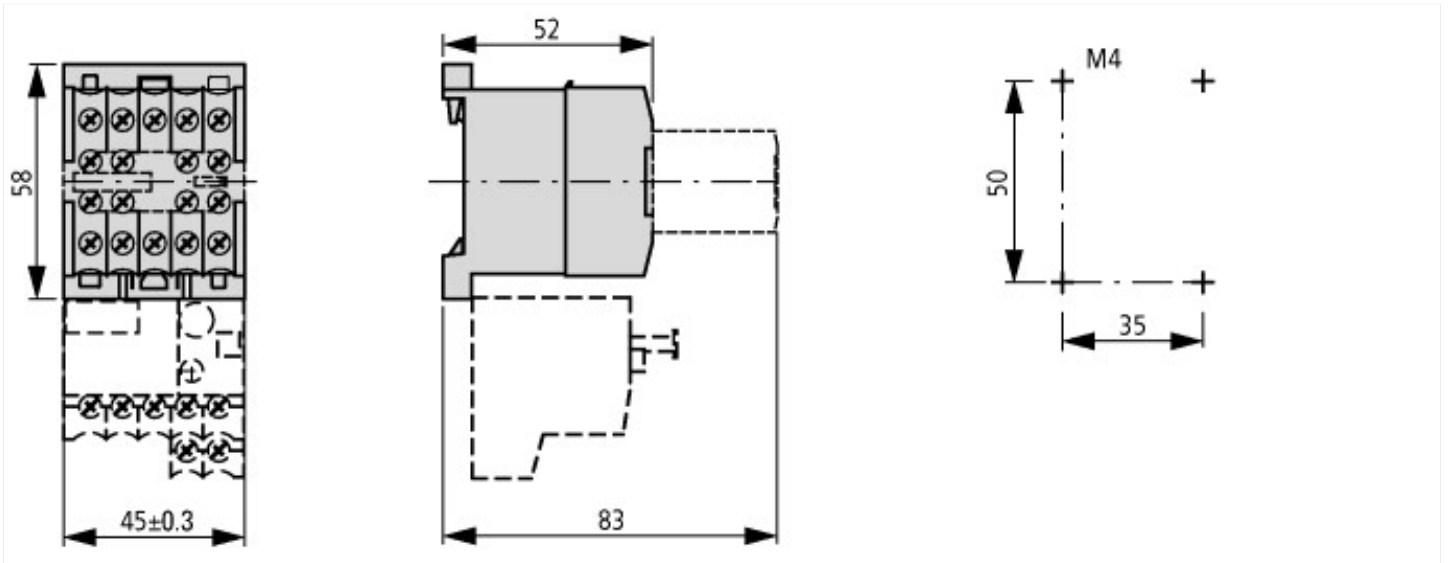

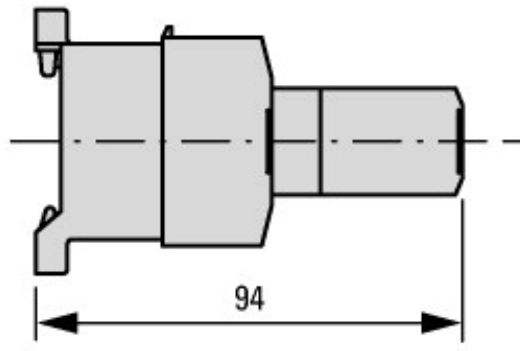
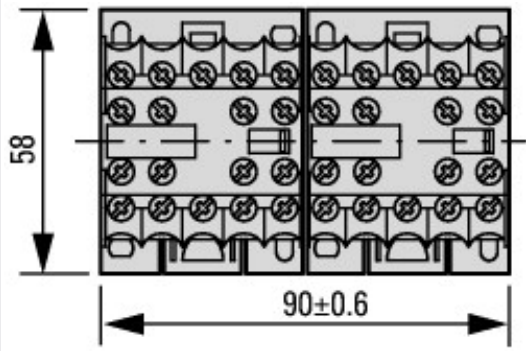

2DILE-... + MVDILE + ...DILE  
2DILE-...-G + MVDILE + ...DILE

## Additional product information (links)

### IL03407009Z (AWA2100-0882) mini contactor relay

IL03407009Z (AWA2100-0882) mini contactor relay

[ftp://ftp.moeller.net/DOCUMENTATION/AWA\\_INSTRUCTIONS/IL03407009Z2016\\_03.pdf](ftp://ftp.moeller.net/DOCUMENTATION/AWA_INSTRUCTIONS/IL03407009Z2016_03.pdf)

UL/CSA: Approved rating data

<http://de.ecat.moeller.net/flip-cat/?edition=HPLTE&startpage=5.84>