



Non-contacting safety switch RS-Titan

Part no. **RS2-12-Q6**
 Article no. **177291**
 Catalog No. **RS2-12-Q6**

Delivery program

Basic function			Position switches Safety position switches
Part group reference			RS
Product range			Non-contacting safety switch
Degree of Protection			IP67, IP69K
Ambient temperature		°C	-10 - +55
Description			Reed contacts
Contacts			
N/O = Normally open			1 N/O
N/C = Normally closed			2 NC
Rated voltage	U_e	V DC	24
Material			Plastic
Connection type			Plug-in connection M12 x 1
Rated switching distance	S_n	mm	8 - 19

Technical data

General

Standards			ISO 13849, ISO 14119, EN 62061
Ambient temperature		°C	-10 - +55
Mechanical shock resistance		g	Semisinusoidal 30 g/11 ms
Vibration			1 mm, 0 - 2000 Hz
relative humidity		%	90 (at 55 °C)
Mounting position			As required
Degree of Protection			IP67, IP69K
Terminal capacity			AWG 22

Power supply

Rated voltage	U_e	V DC	24
---------------	-------	------	----

Contacts/switching capacity

Rated operational current	I_e	A	
DC-13			
24 V	I_e	A	0.3
Repetition accuracy (deviation)		%	± 10

Technical safety parameters:

Values according to EN ISO 13849-1			
Performance level	PL		e
$B10_d$			20000000
Values according to IEC 62061			
			SIL: 3

Design verification as per IEC/EN 61439

Technical data for design verification			
Operating ambient temperature min.		°C	-10
Operating ambient temperature max.		°C	55

Technical data ETIM 6.0

Sensors (EG000026) / Position switch with separate actuator (EC002592)

With status indication		No
Suitable for safety functions		Yes
Width sensor	mm	26
Height of sensor	mm	13
Length of sensor	mm	52
Forced opening		No
Number of safety auxiliary contacts		2
Number of contacts as normally closed contact		2
Number of contacts as normally open contact		1
Number of contacts as change-over contact		0
Type of switching contact		-
Rated operation current I _e at AC-15, 24 V	A	0
Rated operation current I _e at AC-15, 125 V	A	0
Rated operation current I _e at AC-15, 230 V	A	0
Rated operation current I _e at DC-13, 24 V	A	0.03
Rated operation current I _e at DC-13, 125 V	A	0
Rated operation current I _e at DC-13, 230 V	A	0
Housing according to norm		-
Construction type housing		Cuboid
Material housing		Plastic
Housing coating		-
Type of interface		-
Type of interface for safety communication		-
Type of electric connection		Plug-in connection M12
Explosion safety category for gas		None
Explosion safety category for dust		None
Ambient temperature during operating	°C	-10 - 55
Degree of protection (IP)		IP67

Approvals

Product Standards		CE marking
UL File No.		E166051
UL Category Control No.		NRKH, NRKH7
CSA File No.		UL report applies to both Canada und US
North America Certification		UL listed, certified by UL for use in Canada
Degree of Protection		IEC: IP67, IP69K; UL/CSA Type: -

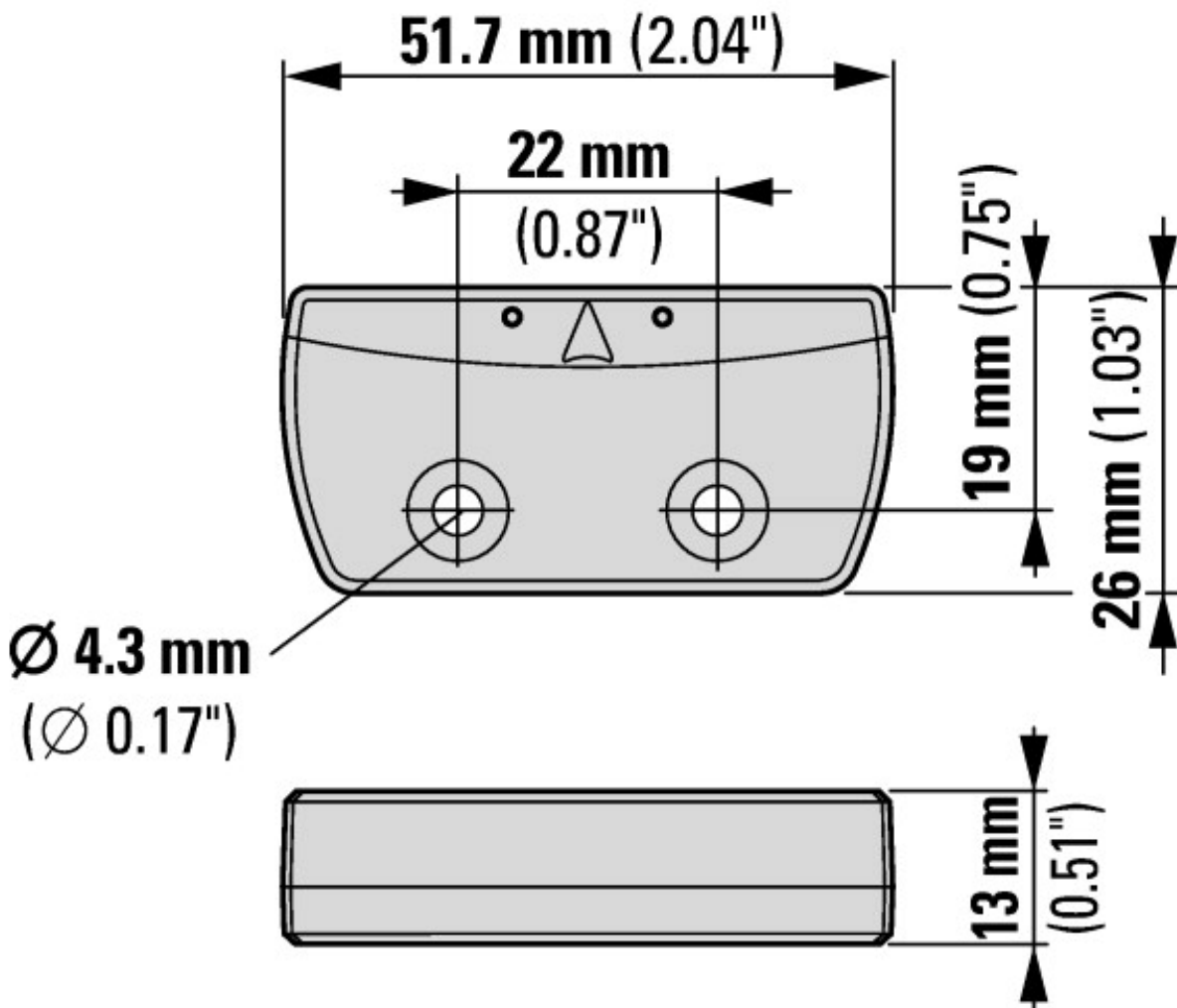
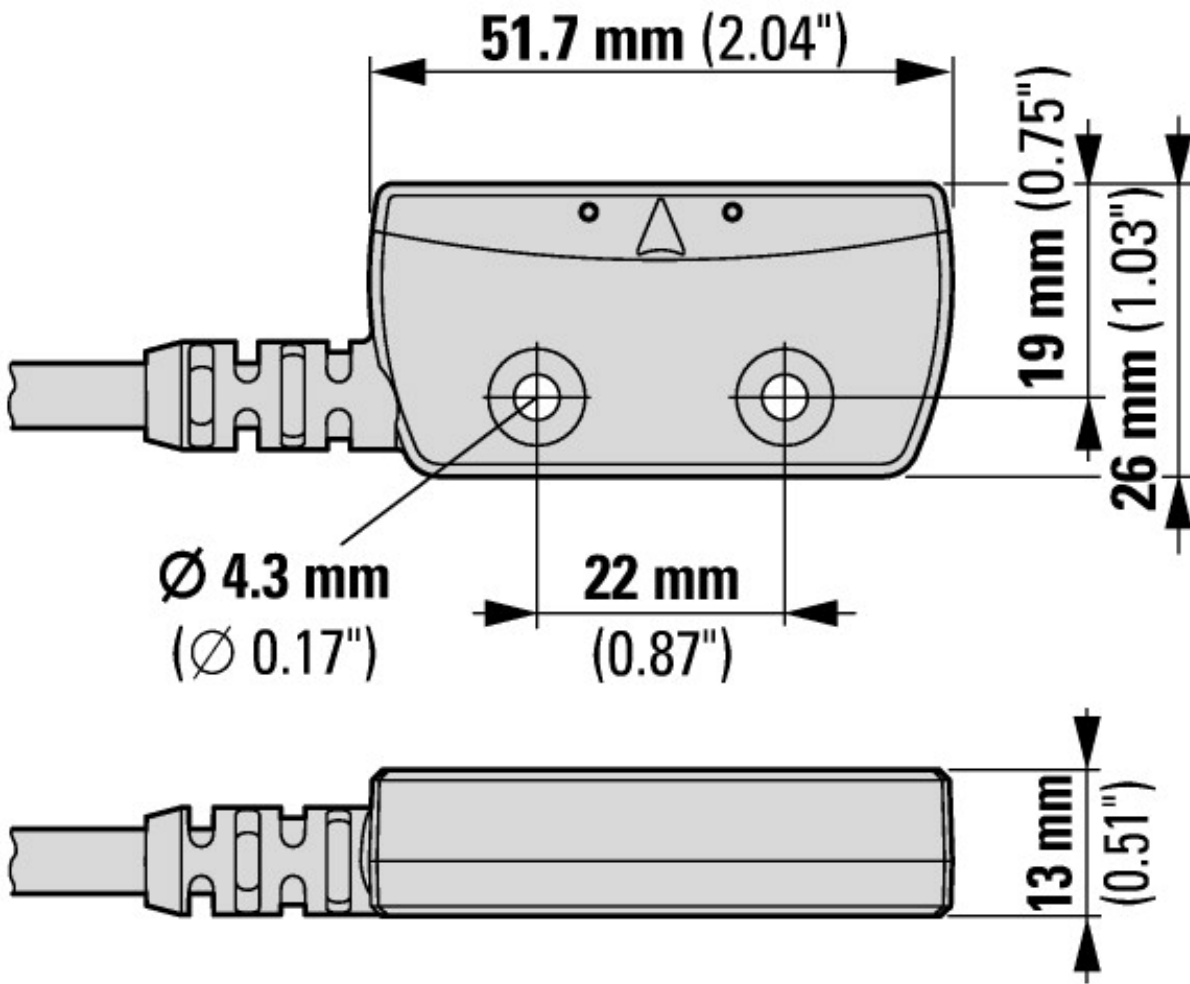

Additional product information (links)

IL053002ZU RS-Titan: Reed Switch Titan

IL053002ZU RS-Titan: Reed Switch Titan

ftp://ftp.moeller.net/DOCUMENTATION/AWA_INSTRUCTIONS/IL053002ZU2016_07.pdf