





**Main switch, 3-pole + 1S + 1Ö, 25A, controlled stop function, lockable in the 0 (Off) position, surface mounting, hard knockout version, with mounting plate screen**

**Part no. P1-25/I2H/MBS/SVB-SW/HI11**  
**Article no. 182416**

## Delivery program

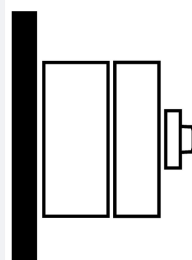
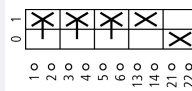
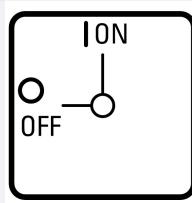
Product range			Main switch maintenance switch Repair switch
Part group reference			P1
Stop Function			STOP function With black rotary handle and locking ring
Notes			hard knockout version with assembly sheet screen
Information about equipment supplied			Auxiliary contact or neutral conductor fitted by user.
Number of poles			3 pole
<b>Auxiliary contacts</b>			
		N/O	1
		N/C	1
Locking facility			Lockable in the 0 (Off) position
Degree of Protection			IP65
			<b>totally insulated</b>
Design			surface mounting 
Contact sequence			
Function			
<b>Motor rating AC-23A, 50 - 60 Hz</b>			
400 V	P	kW	11
Rated uninterrupted current	I <sub>u</sub>	A	25

## Technical data

<b>General</b>			
Standards			IEC/EN 60947, VDE 0660, IEC/EN 60204 Switch-disconnector according to IEC/EN 60947-3
Climatic proofing			Damp heat, constant, to IEC 60068-2-78 Damp heat, cyclic, to IEC 60068-2-30
Ambient temperature			

Enclosed		°C	-20 - +40
Overvoltage category/pollution degree			III/3
Rated impulse withstand voltage	$U_{imp}$	V AC	6000
Mechanical shock resistance		g	15
Mounting position			As required
Protection against direct contact when actuated from front (EN 50274)			Finger and back-of-hand proof

## Contacts

Mechanical variables			
Number of poles			3 pole
Auxiliary contacts			
		N/O	1
		N/C	1
Electrical characteristics			
Rated operational voltage	$U_e$	V AC	690
Rated uninterrupted current	$I_u$	A	25
Note on rated uninterrupted current $I_u$			Rated uninterrupted current $I_u$ is specified for max. cross-section.
Load rating with intermittent operation, class 12			
AB 25 % DF		$x I_e$	2
AB 40 % DF		$x I_e$	1.6
AB 60 % DF		$x I_e$	1.3
Short-circuit rating			
Fuse		A gG/gL	25
Rated short-time withstand current (1 s current)	$I_{cw}$	$A_{rms}$	640
Note on rated short-time withstand current $I_{cw}$			Current for a time of 1 second
Rated conditional short-circuit current	$I_q$	kA	50

## Switching capacity

$\cos \varphi$ rated making capacity as per IEC 60947-3		A	240
Rated breaking capacity $\cos \varphi$ to IEC 60947-3		A	
230 V		A	190
400/415 V		A	150
500 V		A	170
690 V		A	150
Safe isolation to EN 61140			
between the contacts		V AC	440
Current heat loss per contact at $I_e$		W	1.1
Current heat loss per auxiliary circuit at $I_e$ (AC-15/230 V)		CO	0.2
Lifespan, mechanical	Operations	$x 10^6$	> 0.3
Maximum operating frequency	Operations/h		1200
AC			
AC-3			
Rating, motor load switch	P	kW	
220 V 230 V	P	kW	5.5
400 V 415 V	P	kW	7.5
500 V	P	kW	7.5
690 V	P	kW	7.5
Rated operational current motor load switch			
230 V	$I_e$	A	19.6
400V 415 V	$I_e$	A	15.2
500 V	$I_e$	A	12.1
690 V	$I_e$	A	8.8
AC-21A			
Rated operational current switch			
440 V	$I_e$	A	25
AC-23A			

Motor rating AC-23A, 50 - 60 Hz	P	kW	
230 V	P	kW	5.5
400 V 415 V	P	kW	11
500 V	P	kW	11
690 V	P	kW	11
Rated operational current motor load switch			
230 V	I <sub>e</sub>	A	25
400 V 415 V	I <sub>e</sub>	A	25
500 V	I <sub>e</sub>	A	17.4
690 V	I <sub>e</sub>	A	12.6
DC			
DC-1, Load-break switches L/R = 1 ms			
Rated operational current	I <sub>e</sub>	A	25
Voltage per contact pair in series		V	60
DC-23A, motor load switch L/R = 15 ms			
24 V			
Rated operational current	I <sub>e</sub>	A	25
Contacts		Quantity	1
48 V			
Rated operational current	I <sub>e</sub>	A	25
Contacts		Quantity	2
60 V			
Rated operational current	I <sub>e</sub>	A	25
Contacts		Quantity	2
120 V			
Rated operational current	I <sub>e</sub>	A	12
Contacts		Quantity	3
Control circuit reliability at 24 V DC, 10 mA	Fault probability	H <sub>F</sub>	< 10 <sup>-5</sup> , < 1 fault in 100000 operations

### Terminal capacities

Solid or stranded		mm <sup>2</sup>	1 x (1,5 - 6) 2 x (1,5 - 6)
Flexible with ferrules to DIN 46228		mm <sup>2</sup>	1 x (1 - 4) 2 x (1 - 4)
Terminal screw			M4
Max. tightening torque		Nm	1.6

### Technical safety parameters:

<b>Notes</b>			B10 <sub>d</sub> values as per EN ISO 13849-1, table C1
--------------	--	--	---

### Rating data for approved types

Terminal capacity			
Terminal screw			M4

## Technical data ETIM 6.0

Low-voltage industrial components (EG000017) / Switch disconnecter (EC000216)			
Electric engineering, automation, process control engineering / Low-voltage switch technology / Off-load switch, circuit breaker, control switch / Switch disconnecter (ecl@ss8.1-27-37-14-03 [AKF060010])			
Version as main switch			Yes
Version as maintenance-/service switch			Yes
Version as safety switch			No
Version as emergency stop installation			No
Version as reversing switch			No
Max. rated operation voltage U <sub>e</sub> AC		V	690
Rated operating voltage		V	690 - 690
Rated permanent current I <sub>u</sub>		A	25
Rated permanent current at AC-21, 400 V		A	25
Rated operation power at AC-3, 400 V		kW	7,5
Rated short-time withstand current I <sub>cw</sub>		kA	0,64

Rated operation power at AC-23, 400 V	kW	13
Switching power at 400 V	kW	13
Conditioned rated short-circuit current I <sub>q</sub>	kA	80
Number of poles		3
Number of auxiliary contacts as normally closed contact		1
Number of auxiliary contacts as normally open contact		1
Number of auxiliary contacts as change-over contact		0
Motor drive optional		No
Motor drive integrated		No
Voltage release optional		No
Device construction		Complete device in housing
Suitable for ground mounting		Yes
Suitable for front mounting 4-hole		No
Suitable for front mounting center		No
Suitable for distribution board installation		No
Suitable for intermediate mounting		No
Colour control element		Black
Type of control element		Door coupling rotary drive
Interlockable		Yes
Type of electrical connection of main circuit		Screw connection
Degree of protection (IP), front side		IP65

## Dimensions

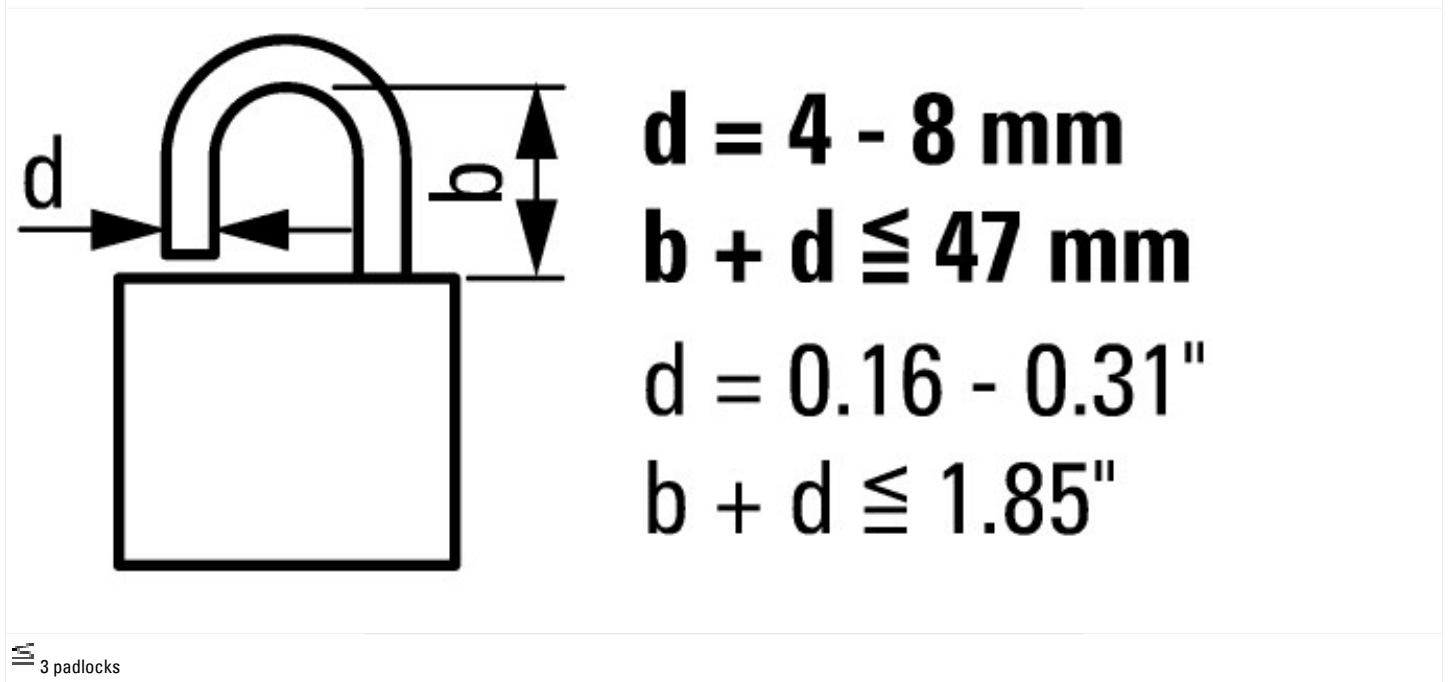
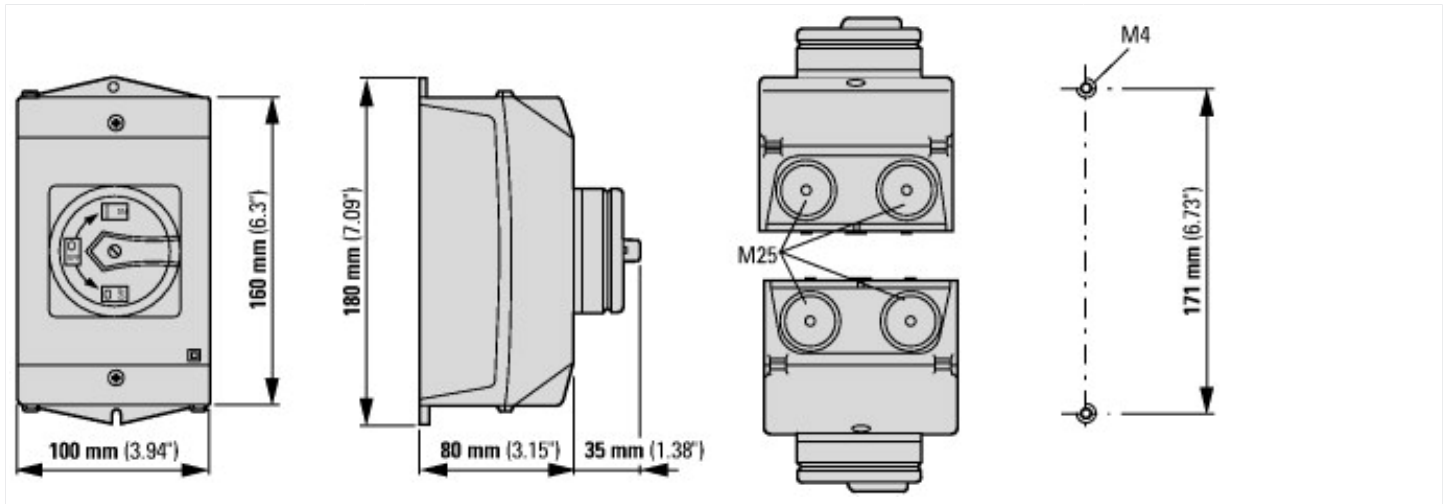

## Additional product information (links)

<b>IL03802001Z (AWA1150-1689) Switch-disconnectors in enclosure</b>	
IL03802001Z (AWA1150-1689) Switch-disconnectors in enclosure	<a href="ftp://ftp.moeller.net/DOCUMENTATION/AWA_INSTRUCTIONS/IL03802001Z2016_07.pdf">ftp://ftp.moeller.net/DOCUMENTATION/AWA_INSTRUCTIONS/IL03802001Z2016_07.pdf</a>
<b>IL03801013Z (AWA1150-2249) Sheet screen mounting</b>	
IL03801013Z (AWA1150-2249) Sheet screen mounting	<a href="ftp://ftp.moeller.net/DOCUMENTATION/AWA_INSTRUCTIONS/IL03801013Z2014_07.pdf">ftp://ftp.moeller.net/DOCUMENTATION/AWA_INSTRUCTIONS/IL03801013Z2014_07.pdf</a>
Technical overview cam switch, switch-disconnector	<a href="http://de.ecat.moeller.net/flip-cat/?edition=HPLTEv1&amp;startpage=4.2">http://de.ecat.moeller.net/flip-cat/?edition=HPLTEv1&amp;startpage=4.2</a>
System overview cam switch T	<a href="http://de.ecat.moeller.net/flip-cat/?edition=HPLTEv1&amp;startpage=4.4">http://de.ecat.moeller.net/flip-cat/?edition=HPLTEv1&amp;startpage=4.4</a>
System overview switch-disconnector P	<a href="http://de.ecat.moeller.net/flip-cat/?edition=HPLTEv1&amp;startpage=4.6">http://de.ecat.moeller.net/flip-cat/?edition=HPLTEv1&amp;startpage=4.6</a>
Key to part numbers Cam switch	<a href="http://de.ecat.moeller.net/flip-cat/?edition=HPLTEv1&amp;startpage=4.8">http://de.ecat.moeller.net/flip-cat/?edition=HPLTEv1&amp;startpage=4.8</a>
Key to part numbers Switch-disconnector	<a href="http://de.ecat.moeller.net/flip-cat/?edition=HPLTEv1&amp;startpage=4.8">http://de.ecat.moeller.net/flip-cat/?edition=HPLTEv1&amp;startpage=4.8</a>
Switches for ATEX	<a href="http://www.coopercrouse-hinds.eu/en/products/25-ex-safety-and-main-current-switches.html">http://www.coopercrouse-hinds.eu/en/products/25-ex-safety-and-main-current-switches.html</a>